

2014 Owner's Manual

Portable Spas

International - ENGLISH



© 2013 LMS, Inc.



Cal Spas Home Resort™

Preparing for Your New Portable Spa

Pre-Delivery Checklist	3
Planning the Best Location	3
Preparing a Good Foundation	4
230V / 50 Hz Electrical Installation	5
Filling and Powering Up Your Portable Spa	12
Priming the Pump	14

Operating Your Spa

TP400 and TP600 Control Panel Operation	16
TP800 Control Panel Operation	25
Cal Spas Hot Tub WiFi App	30
Electrical Power Efficiency	32
Adjustable Jets	32
LED Perimeter Lighting	32
Diverter Knobs	33
Waterfalls	33
Air Venturis	33
Hydro Streamer Waterfall	33
Adjustable Therapy System	34
VariMax System	34

Water Clarity

The Key to Clear Water	35
Testing and Adjusting Spa Water	36
Sanitation	37
Bather Load	38
Filter Cleaning	38
Pure Cure™ Water Sanitizer	39
Ozonator	39
Cal Clarity II Bromine Generator	40
Maintenance Schedule	42
Troubleshooting Water Clarity Problems . .	43

Cleaning and Maintenance

Removing and Reseating the Pillows	44
Jet Removal and Replacement	44
Spa Cover	44
Draining Your Portable Spa	45
Winterizing (Cold Climate Draining)	46
Cleaning and Replacing the Filter	47
Vacation Care	47
Cleaning Your Spa	47
Changing the UV Lamp	48

Using the Entertainment System

Aquatic AV AQ-DM-3B Media Locker	49
Aquavibe MD-350 Docking Station	50

Keeping Fit With Your Swim Spa

Jetstream Propulsion System	52
Assembling the Swim Tether	52
Using the Exercise Equipment	53

Appendix

Replacement Parts	54
Troubleshooting	61
Limited Warranty	64

Copyright 2014 Lloyd's Material Supply, Inc. All rights reserved. Duplication without written consent is strictly prohibited.

Cal Spas™, Adjustable Therapy System™, ATSTM, Cal Premium™, Cal Select™, Cal Stone™, Ultimate Fitness Spa Series™, and XL Heat Exchanger™ are registered trademarks.

Due to continuous improvement programs, all models, operation, and/or specifications are subject to change without prior notice.

LTR20141001, Rev. B

6/2/14

100-1347

CONTACT INFORMATION

For customer service, please contact your authorized dealer immediately. If you need additional information and/or assistance, please contact:

LMS Customer Service Department
1462 East Ninth Street
Pomona, CA 91766.

Phone: 1-909-623-8781
Fax: 1-909-629-3890

Important Safety Instructions

READ AND FOLLOW ALL INSTRUCTIONS.

DANGER -- Risk of accidental drowning:

Do not allow children to be in or around a spa unless a responsible adult supervises them. Keep the spa cover on and locked when not in use. See instructions enclosed with your cover for locking procedures.

DANGER -- Risk of injury:

The suction fittings in this spa are sized to match the specific water flow created by the pump. Should the need arise to replace the suction fittings, or the pump, be sure the flow rates are compatible.

Never operate the spa if the suction fitting or filter baskets are broken or missing. Never replace a suction fitting with one that is rated less than the flow rate marked on the original suction fitting.

DANGER -- Risk of electric shock:

Install the spa at least 1.5 meters from all metal surfaces. As an alternative, a spa may be installed within 5 feet of metal surfaces if each metal surface is permanently bonded by a minimum #8 AWG solid copper conductor to the outside of the spa's control box.

Do not permit any external electrical appliances, such as lights, telephones, radios, televisions, and etc., within five feet of the spa. Never attempt to operate any electrical device from inside the spa.

Replace a damaged power cord immediately.

Do not bury the power cord.

Connect to a grounded, grounding-type receptacle only.

WARNING -- To reduce the risk of injury:

The spa water should never exceed 40°C (104°F). Water temperatures between 38°C and 40°C (100°F and 104°F) are considered safe for a healthy adult. Lower water temperatures are recommended for young children and when spa use exceeds 10 minutes.

High water temperatures have a high potential for causing fetal damage during pregnancy. Women who are pregnant, or who think they are pregnant, should always check with their physician prior to spa usage.

The use of alcohol, drugs or medication before or during spa use may lead to unconsciousness, with the possibility of drowning.

Persons suffering from obesity, a medical history of heart disease, low or high blood pressure, circulatory system problems or diabetes should consult a physician before using the spa.

Persons using medications should consult a physician before using the spa since some medications may induce drowsiness while others may affect heart rate, blood pressure and circulation.

HYPERTHERMIA DANGER:

Prolonged exposure to hot air or water can induce hyperthermia. Hyperthermia occurs when the internal temperature of the body reaches a level 2°C to 4°C (1°C to 2°C) above the normal body temperature of 37°C (98.6°F). While hyperthermia has many health benefits, it is important not to allow your body's core temperature to rise above 39.5°C (103°F).

Symptoms of excessive hyperthermia include dizziness, lethargy, drowsiness and fainting. The effects of excessive hyperthermia may include:

- Failure to perceive heat
- Failure to recognize the need to exit spa or hot tub
- Unawareness of impending hazard
- Fetal damage in pregnant women
- Physical inability to exit the spa
- Unconsciousness

WARNING: The use of alcohol, drugs, or medication can greatly increase the risk of fatal hyperthermia.

WARNING: People with infectious diseases should not use a spa or hot tub.

WARNING: To avoid injury, exercise care when entering or exiting the spa or hot tub.

WARNING: Do not use drugs or alcohol before or during the use of a spa or hot tub to avoid unconsciousness and possible drowning.

WARNING: Do not use a spa or hot tub immediately following strenuous exercise.

WARNING: Prolonged immersion in a spa or hot tub may be injurious to your health.

CAUTION: Maintain water chemistry in accordance with manufacturer's instructions.

SAVE THESE INSTRUCTIONS.



Preparing for Your New Portable Spa

Pre-Delivery Checklist

Most cities and counties require permits for exterior construction and electrical circuits. In addition, some communities have codes requiring residential barriers such as fencing and/or self-closing gates on property to prevent unsupervised access to the property by children under the age of 5. Your dealer can provide information on which permits may be required and how to obtain them prior to the delivery of your spa.

For additional operating and installation information, please see your selling dealer.

Before Delivery	
	Plan your delivery route
	Choose a suitable location for the spa
	Lay a 5 - 8 cm concrete slab
	Install dedicated electrical supply
After Delivery	
	Place spa on slab
	Connect electrical components

Planning the Best Location

Safety First

Do not place your spa within 10 feet (3 m) of overhead power lines.

Consider How You Will Use Your Spa

How you intend to use your spa will help you determine where you should position it. For example, will you use your spa for recreational or therapeutic purposes? If your spa is mainly used for family recreation, be sure to leave plenty of room around it for activity. If you will use it for relaxation and therapy, you will probably want to create a specific mood around it.

Plan for Your Environment

If you live in a region where it snows in the winter or rains frequently, place the spa near a house entry. By doing this, you will have a place to change clothes and not be uncomfortable.

Consider Your Privacy

In a cold-weather climate, bare trees won't provide much privacy. Think of your spa's surroundings during all seasons to determine your best privacy options. Consider the view of your neighbors as well when you plan the location of your spa.

Provide a View with Your Spa

Think about the direction you will be facing when sitting in your spa. Do you have a special landscaped area in your yard that you find enjoyable? Perhaps there is an area that catches a soothing breeze during the day or a lovely sunset in the evening.

Keep Your Spa Clean

In planning your spa's location, consider a location where the path to and from the house can be kept clean and free of debris.

Prevent dirt and contaminants from being tracked into your spa by placing a foot mat at the spa's entrance where the bathers can clean their feet before entering your spa.

Allow for Service Access

Many people choose to install a decorative structure around their spa. If you are installing your spa with any type of structure on the outside, such as a gazebo, remember to allow access for service. It is always best to design special installations so that the spa can still be moved, or lifted off the ground.

Preparing a Good Foundation

Your spa needs a solid and level foundation. The area that it sits on must be able to support the weight of the spa and the occupants who use it. If the foundation is inadequate, it may shift or settle after the spa is in place, causing stress that could damage your spa shell or finish.

Damage caused by inadequate or improper foundation support is not covered by the warranty. It is the responsibility of the spa owner to provide a proper foundation for the spa.

Place the spa on an elevated 10 cm concrete slab. Pavers, gravel, brick, sand, timbers or dirt foundations are not adequate to support the spa.

We strongly recommended that you have a qualified, licensed contractor prepare the foundation for your spa.

If you are installing the spa indoors, pay close attention to the flooring beneath it. Choose flooring that will not be damaged or stained.

If you are installing your spa on an elevated wood deck or other structure, it is highly recommended that you consult a structural engineer or contractor to ensure the structure will support the weight of 732 kg / m² (150 lbs / ft²).

To properly identify the weight of your new spa when full, remember water weighs 1 kg per liter. For example, an average 2.4 meter (8 foot) spa holds approximately 1892 liters of water. Using this formula, you will find that the weight of the water alone is 1892 kg. Combined with the dry weight of the spa you will note that this spa will weigh approximately 2267 kg when full of water.



230V / 50 Hz Electrical Installation

All 230V spas must be permanently connected (hardwired) to the power supply. These instructions describe the only acceptable electrical wiring procedure. Spas wired in any other way will void your warranty and may result in serious injury.

This is the only acceptable electrical wiring procedure. Spas wired in any other way will void your warranty. See the wiring requirements below and wiring diagrams on page 6 through page 11.

The electrical wiring of this spa must meet the requirements of any applicable local, state, and federal codes. The electrical circuit must be installed by an electrical contractor and approved by a local building / electrical inspector.

The power supplied to the spa must be on a dedicated

RCD protected circuit with no other appliances or lights sharing the power.

Use copper wire with THHN insulation. Do not use aluminum wire.

Use the tables below to determine your RCD and wiring requirements.

When wires larger than #6 AWG are required, install a junction box near the spa and use #6 AWG wire between the junction box and the spa.

Wire runs over 25 meters must increase wire gauge to the next lower number. For example: A normal 50 amp RCD with three #8 AWG copper wires run over 25 meters would require you to go to three #6 AWG copper wires.

RCD and Wiring Requirements

Note: SINGLE PHASE ONLY!

Three phase power requires 400V.
Only use 230V.

Use this table to determine your wiring configuration.

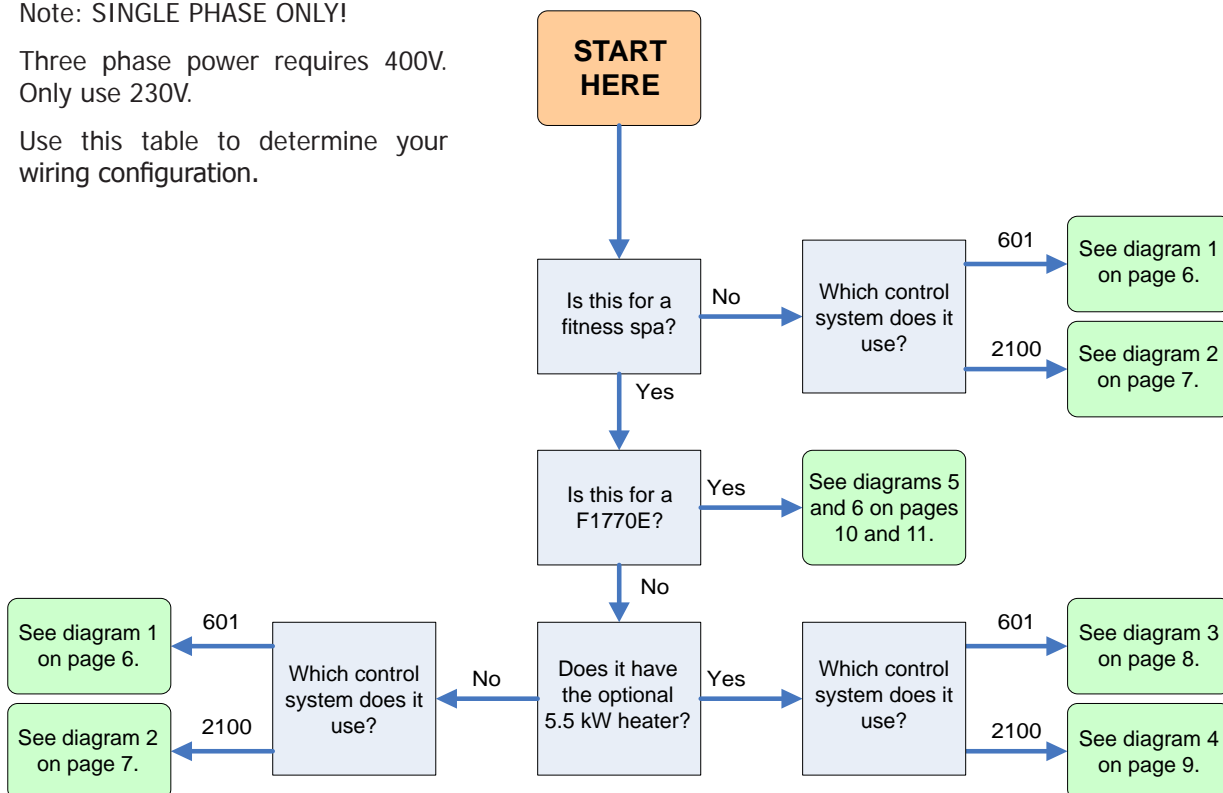
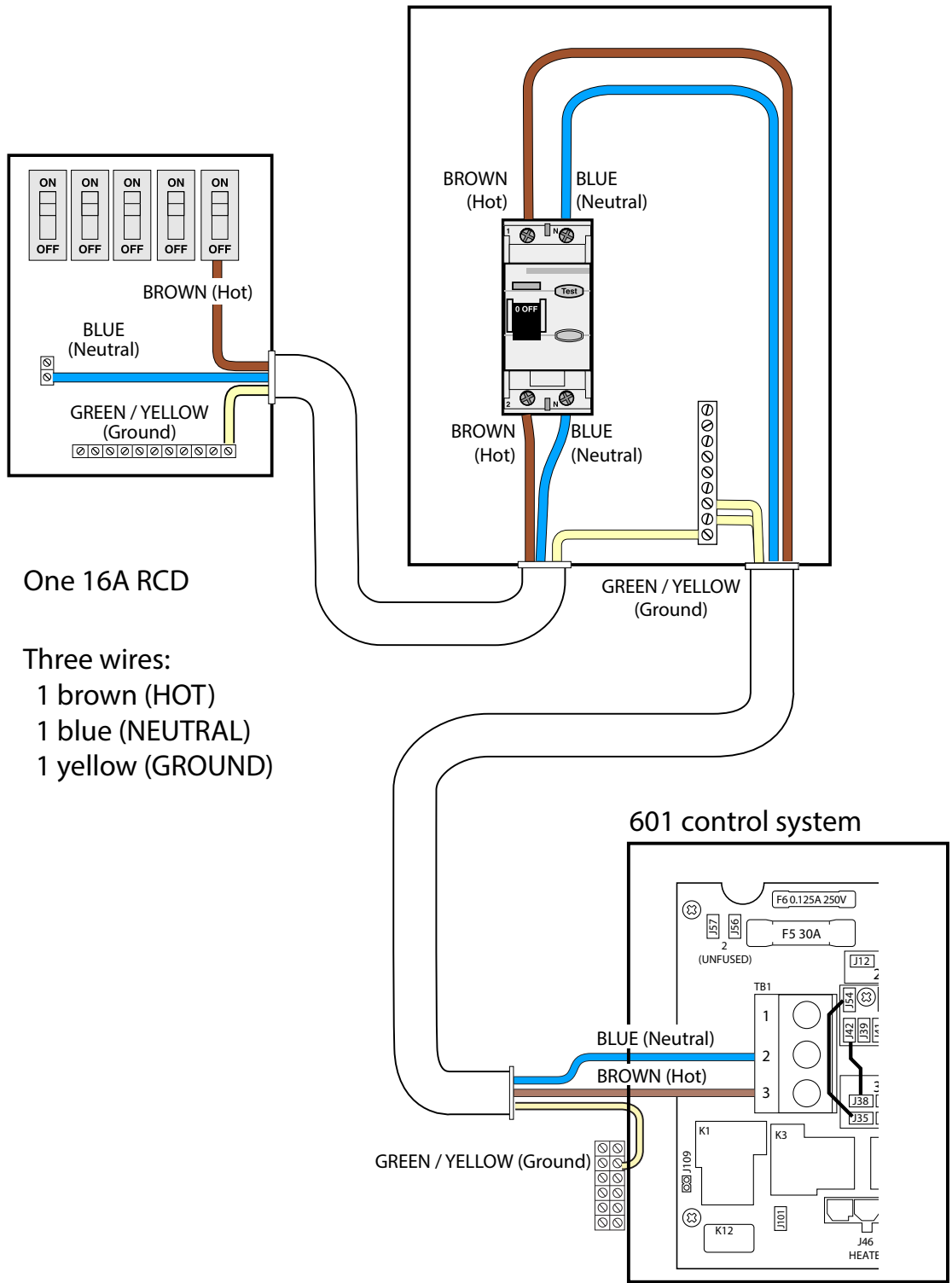

Diagram 1



One 16A RCD

- Three wires:
 1 brown (HOT)
 1 blue (NEUTRAL)
 1 yellow (GROUND)

601 control system

Diagram 2

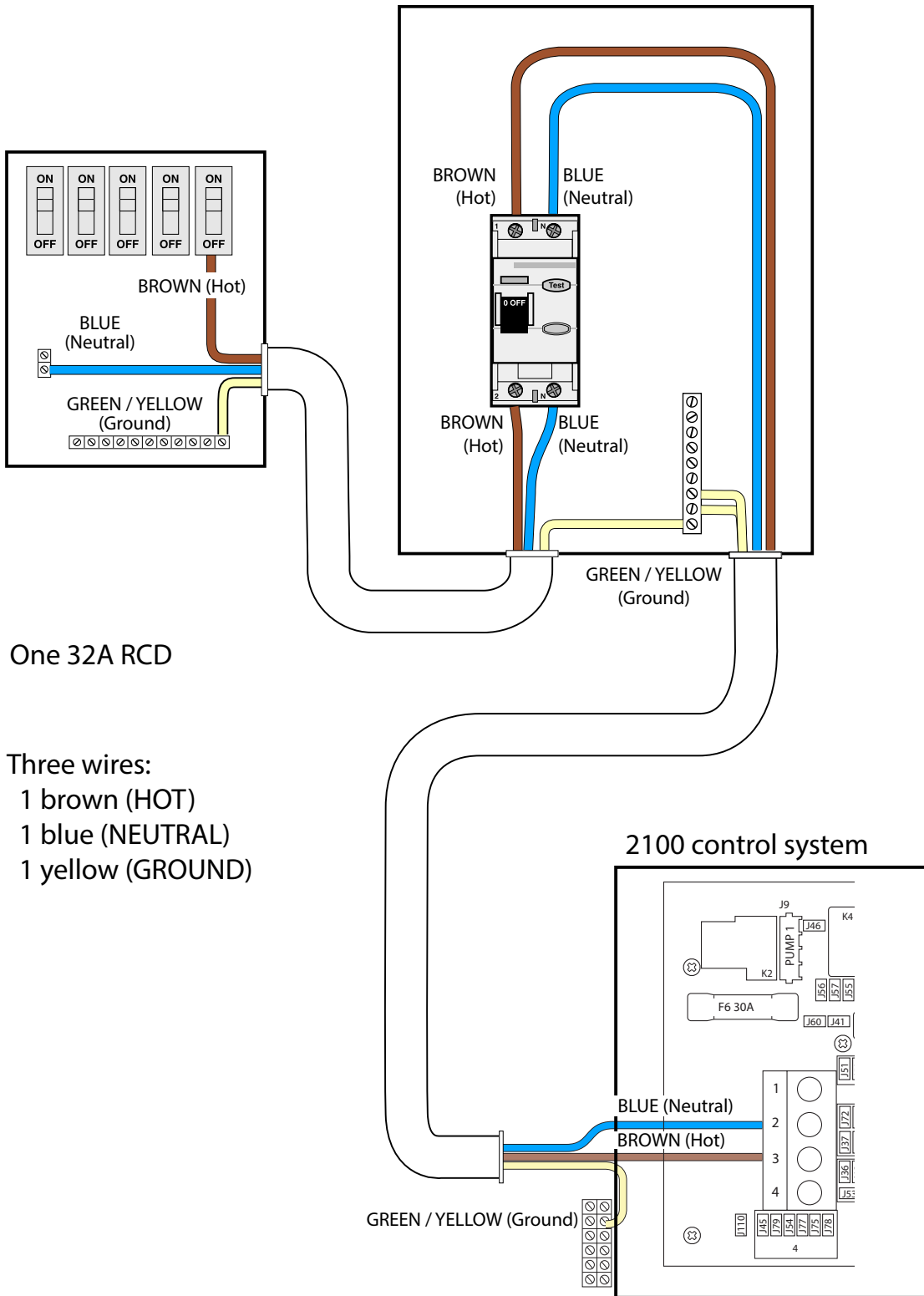
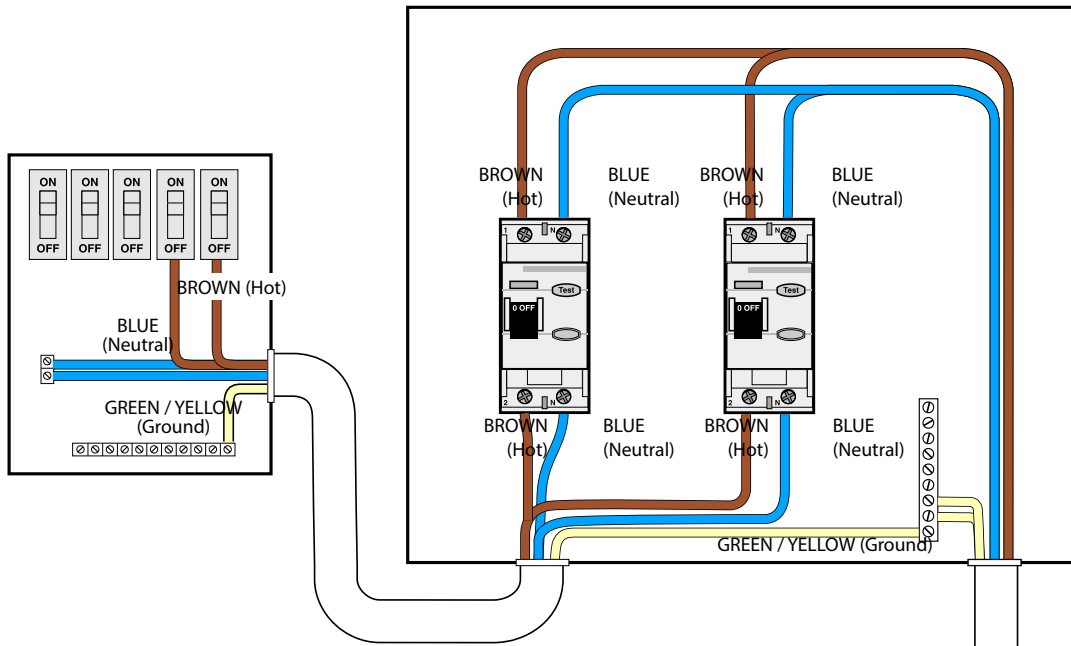

Diagram 3



Two 16A RCDs

Six wires:

- 2 brown (HOT)
- 2 blue (NEUTRAL)
- 2 yellow (GROUND)

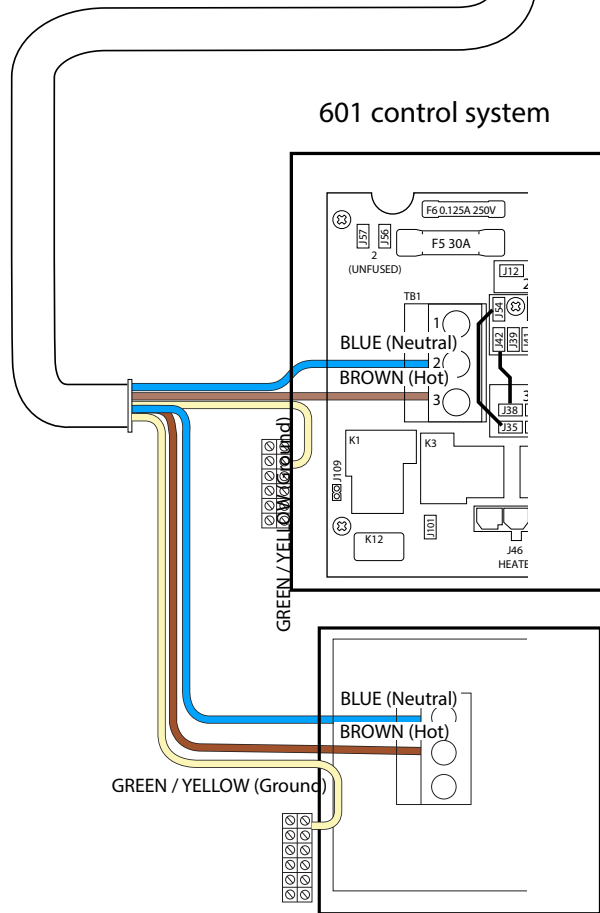

601 control system

5.5 kW heater box

Diagram 4

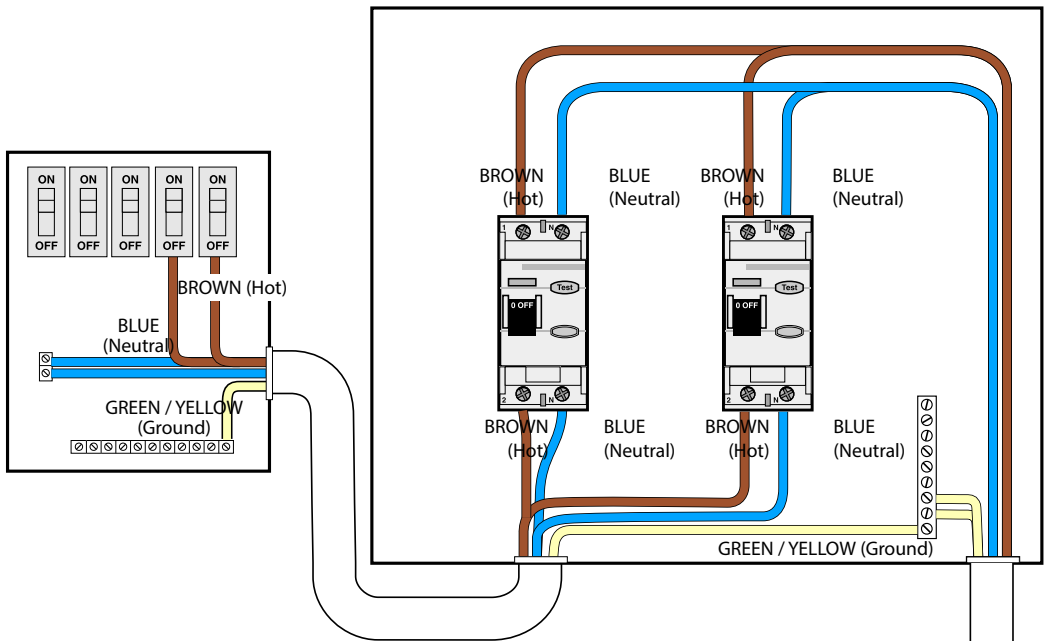

One 32A RCD
(connect to 2100 control system)

One 16A RCD
(connect to 5.5 kW heater box)

Six wires:
2 brown (HOT)
2 blue (NEUTRAL)
2 yellow (GROUND)

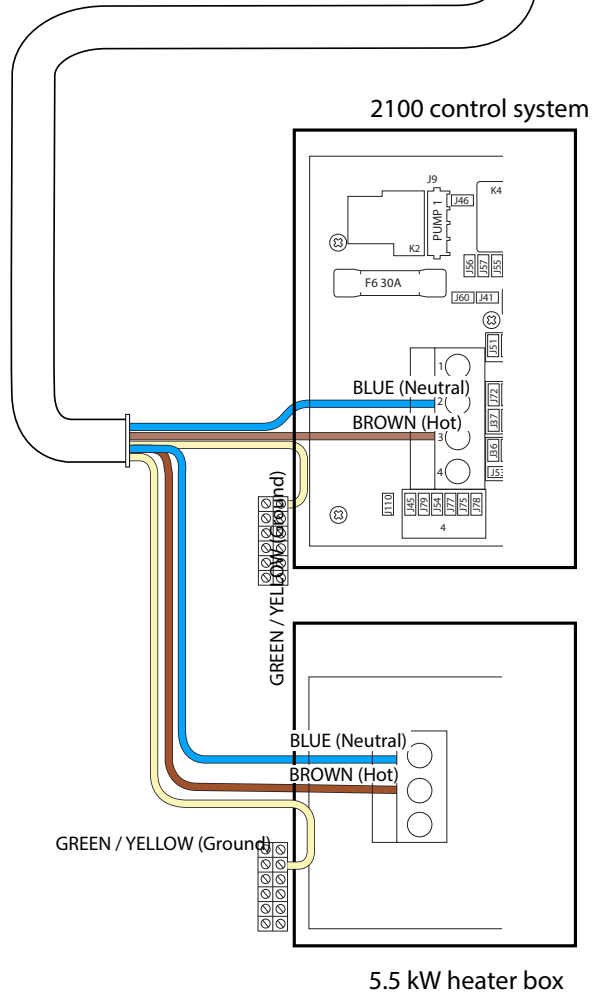

Diagram 5

With 3.0 kW heater only

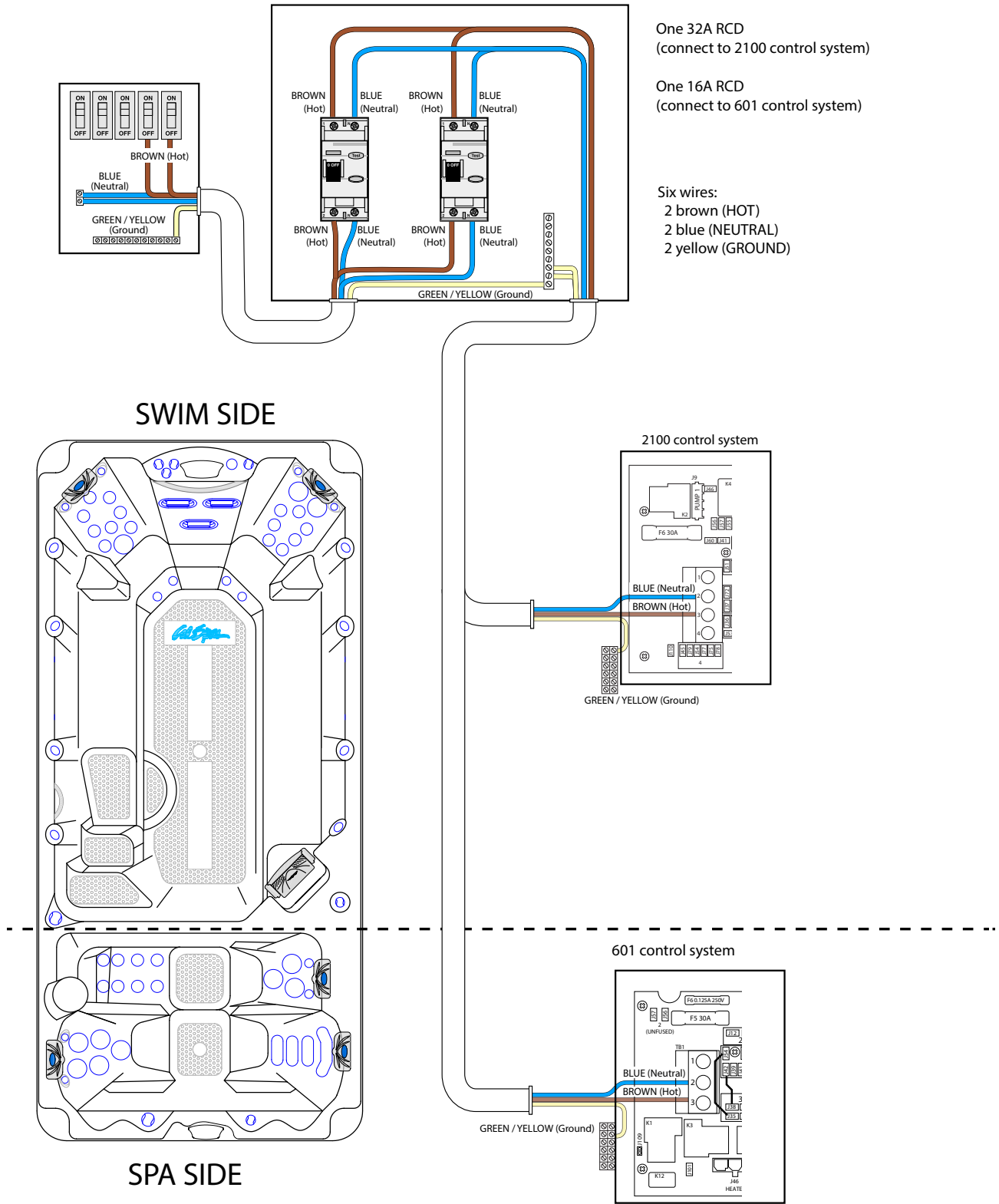
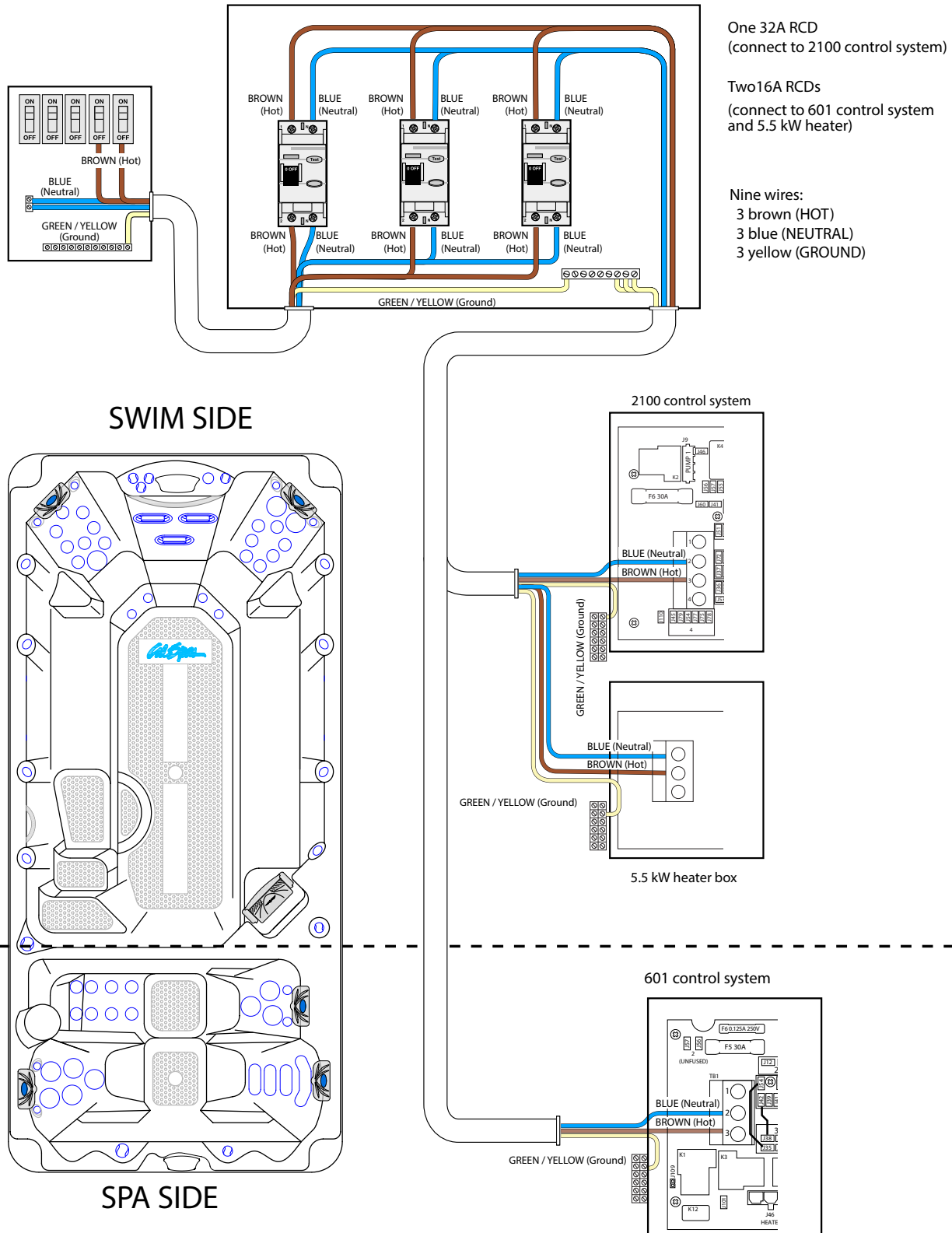

Diagram 6

With 3.0 kW heater and 5.5 kW heater



Filling and Powering Up Your Portable Spa

This applies to all spa owners **EXCEPT** those with the Cal Clarity II bromine generator. See instructions on page 40 for bromine generator operating instructions and spa filling procedures.

1. Inspect the spa equipment.



After the spa has been placed on an approved surface and has been correctly wired by a licensed electrician, inspect all plumbing connections in the equipment area of your spa. Ensure that these connections are secure and that they did not loosen during shipment.

If your spa has gate valves, make sure they are all in the UP or OPEN position.

Never run the spa with the gate valves closed or without water circulating for long periods of time. Be careful not to over-tighten the plumbing fittings.

2. Remove the cartridge from filter canister.



Unscrew the cartridge and remove it.



After you remove the filter, remove the plastic wrapper and soak it in water for 30 minutes before you replace it. A dry filter can allow air into the filtration system which can cause the pump to fail to prime.

3. Fill the spa.



Place a garden hose in the filter canister and fill your spa with **regular tap water** about 15 cm from the top.

If the water level is too low or too high, your spa will not operate properly.



Always fill the spa through the filter canister! Failure to do so may cause air to be trapped in the filtration system and prevent the pumps from operating properly.



Never fill your spa with soft water.

Soft water makes it impossible to maintain the proper water chemistry and may cause the water to foam, which will ultimately harm the finish of the spa and void your warranty.



4. Turn on power to the spa.



When the spa is filled to the correct level, turn on the power at the RCD breaker.

5. Prime the pump.



Your spa will perform a self-diagnostic check and go into Priming Mode. The control panel will display either **RUN PUMPS PURG AIR ---** or **Priming Mode**, depending on which control panel you have.

Do the following:

1. Press the JETS or JETS 1 button once to start the pump in low speed.
2. Press it again to switch the pump to high speed.
3. If you have other pumps, press JETS 2 or JETS 3 to turn them on also.

Running the pumps helps the pumps prime.

After two minutes, the pump should prime. If it does not, follow the priming instructions on the next page. If it does, continue with the next step.

6. Install the filter into the filter canister.



 Make sure the filter has soaked at least 30 minutes before you install it.

7. Adjust water chemistry.

After the spa has run for two hours, test and adjust the water chemistry. See the section on page 35 for instructions on water clarity.

8. Let the spa heat up.

When the spa has finished priming, the heater will activate.

Put the cover on and let the spa run for two hours.

Priming the Pump

New spa owners often have difficulty the first time they start their spa and the pump fails to prime. This can be frustrating, but these simple instructions can help you.

Sometimes air can become trapped in the pump while filling the spa. You will know this has happened when after you have filled and started the spa, the pump does not seem to function. You will hear the pump operating, but no water will be moving.



The pump will not work properly while air is trapped in it. Continuing to operate the pump in this way will cause damage.

Starting Up: Priming Mode

After the initial start-up sequence, the spa will enter Priming Mode, which lasts 4 to 5 minutes. Depending on your control panel, one of the messages shown at right will appear.

As soon as the Priming Mode screen appears on the panel, press the Jets or Jets 1 button once to start Pump 1 in low speed and then again to switch to high speed. Also, select the other pumps, to turn them on. The pumps should be running in high speed to facilitate priming.

If the pumps have not primed after two minutes, and water is not flowing from the jets in the spa, do not allow the pumps to continue to run. Turn off the pumps and repeat the process. Note: Turning the power off and back on again will initiate a new pump priming session.

Sometimes momentarily turning the pump off and on will help it to prime. Do not do this more than five times. If the pumps will not prime, shut off the power to the spa and call for service.

Important: A pump should not be allowed to run without priming for more than two minutes. Under NO circumstances should a pump be allowed to run without priming beyond the end of the 4 to 5 minute priming mode. Doing so may cause damage to the pump and cause the system to energize the heater and go into an overheat condition.



Exiting Priming Mode

You can manually exit Priming Mode by pressing an Up or Down button. Note that if you do not manually exit the priming mode as described above, the priming mode will be automatically terminated after 4 to 5 minutes. Be sure that the pumps have been primed by this time.

Once the system has exited Priming Mode, the top-side panel will momentarily display the set temperature but the display will not show the temperature yet. This is because the system requires approximately one minute of water flowing through the heater to determine the water temperature and display it.

Bleeding Air from the Pump

If you have tried priming the pump several times unsuccessfully using the control panel, you can bleed the air from the pump manually.

1. Shut off the power to the spa.
2. Using a Phillips screwdriver, remove the front panel from the spa and locate the pump.
3. Close the gate valve on the discharge side of the pump (if your spa is installed with one.)
4. Turn the bleeder valve counter clockwise with a small pair of pliers until the air has been released from the pump.
5. If this is unsuccessful, loosen the union nut on side of the pump with channel locks. When air is bled out, tighten the nut.
6. Turn on power to the spa and press the JETS button. If there is still air trapped in the pump, repeat steps 2 through 5 until the pump primes.

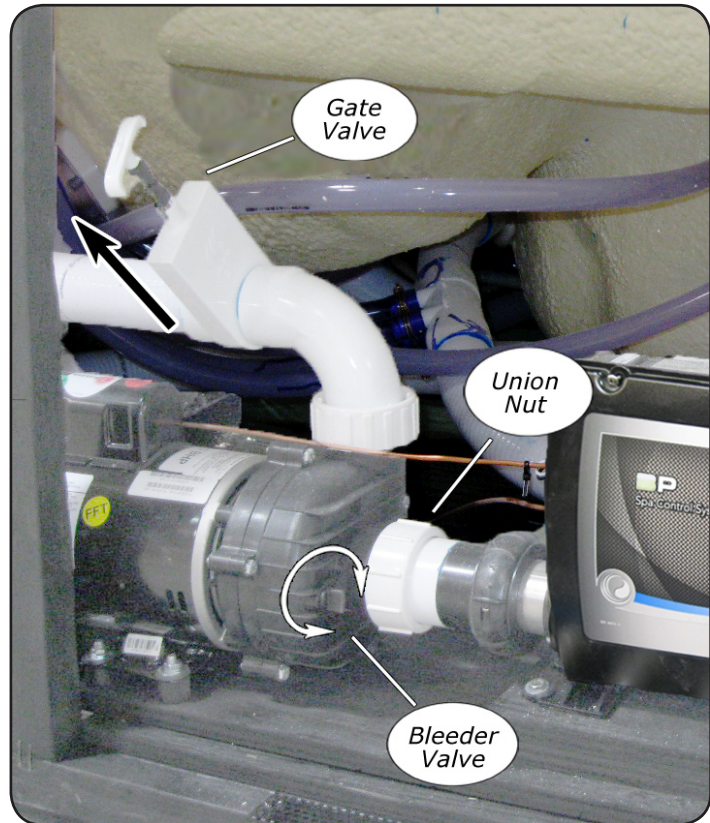

Operating Your Spa

TP400 and TP600 Control Panel Operation



TP400 Control Panel



TP600 Control Panel

Primary Navigation and Functions

Navigating the entire menu structure is done with 2 or 3 buttons on the control panel.

You can use either Temperature button (Warm and Cool) to navigate and program where a single Temperature icon is shown.

The Light Button is also used to choose the various menus and navigate each section.

Typical use of the Temperature buttons allows changing the Set Temperature while the numbers are flashing in the LCD.

Pressing the LIGHT button while the numbers are flashing will enter the menus.



The menus can be exited with certain button presses. Waiting several seconds in any screen will allow the display to revert to the main screen.

Most changes are not saved unless the Light button is pressed.

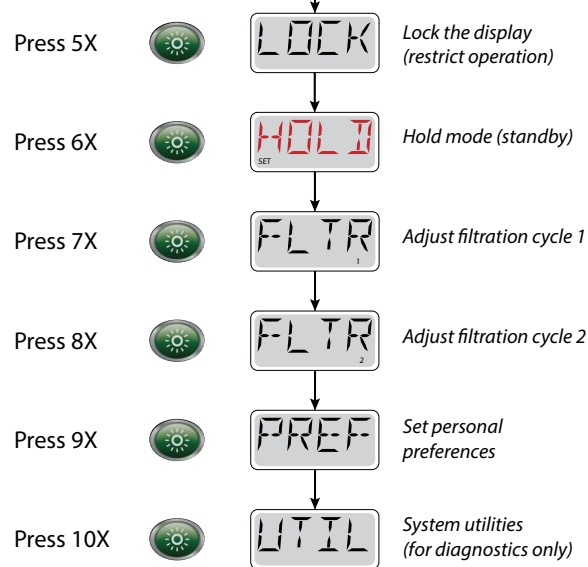
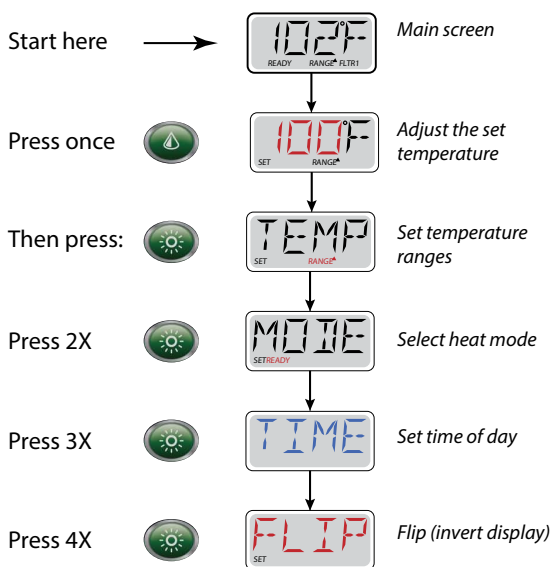

Adjusting the Set Temperature

Press  Once

Press the WARM or COOL buttons to adjust the set temperature. When the temperature stops flashing, the spa will heat to the new set temperature when required. The temperature can be set between 15.5°C and 40°C (60°F and 104°F).

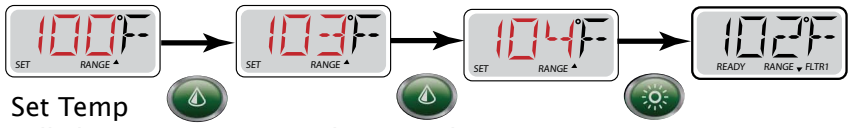



Set Temp will show and flash

Press the Temp buttons to change the temperature.

Main Screen

Setting Dual Temperature Ranges

Press  Once

Then Press  Once

You can set two temperature range settings with independent set temperatures. The High Range is shown in the display by an "up" arrow and the Low Range with a "down" arrow. The ranges can be used for different reasons, the most common being a "ready to use" setting versus a "vacation" setting. (See "Vacation Setting" below.) Each range maintains its own set temperature that you program according to your needs. This way, when a range is chosen, the spa will heat to the set temperature programmed to that range.

High Range can be set between 26.5°C and 40°C (80°F and 104°F).

Low Range can be set between 10°C and 37°C (50°F and 99°F).

The example below shows setting the Low Range temperature.

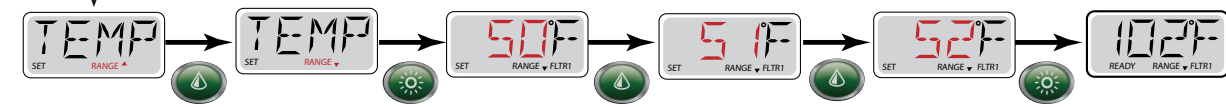

Select High Range or Low Range. Toggle the Range arrows on the display.

Set Temp will show and flash

Press a Temp Button repeatedly to change the temperature.



Main Screen

Vacation Setting

Set the spa to operate in the Lower Range temperature choice before you go on vacation.

1. Press the Temp button. The "Set Temp" will show and flash.
2. Press the Light button. "TEMP" will show on the display, which give you the choice of High Range or Low Range.
3. To set the Low Range, press the Light button, then press the Temp button. The "Set Temp" will show and flash.
4. Press the Temp buttons to adjust the temperature.
5. Press the Light button or wait several seconds to return to the main screen.

Setting the Heat Mode

Press  Once
Then Press  Twice

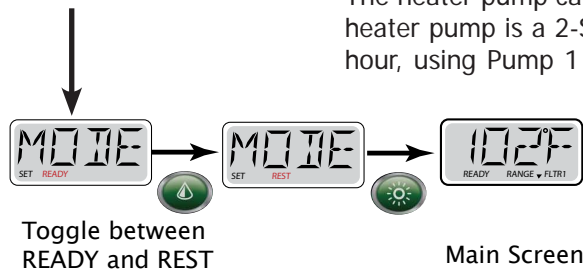

There are two heat modes: READY Mode and REST Mode.

READY Mode: In order for the spa to heat, a pump needs to circulate water through the heater. The pump that performs this function is known as the “heater pump.”

The heater pump can be either a 2-Speed Pump 1 or a circulation pump. If the heater pump is a 2-Speed Pump 1, READY Mode will circulate water every 1/2 hour, using Pump 1 Low, in order to maintain a constant water temperature, heat as needed, and refresh the temperature display. This is known as “polling.”



REST Mode: REST Mode will only allow heating during programmed filter cycles. Since polling does not occur, the temperature display may not show a current temperature until the heater pump has been running for a minute or two.

Ready-in-Rest Mode

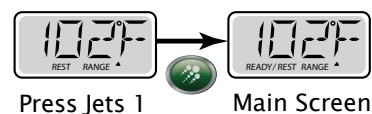
READY/REST appears in the display if the spa is in Rest Mode and Jet 1 is pressed. When the spa is being used, it will heat to set temperature. While Pump 1 High can be turned on and off, Pump 1 Low will run until set temperature is reached, or 1 hour has passed. After 1 hour, the system will revert to Rest Mode. This mode can also be reset by entering the Mode Menu and changing the Mode.



Setting Time

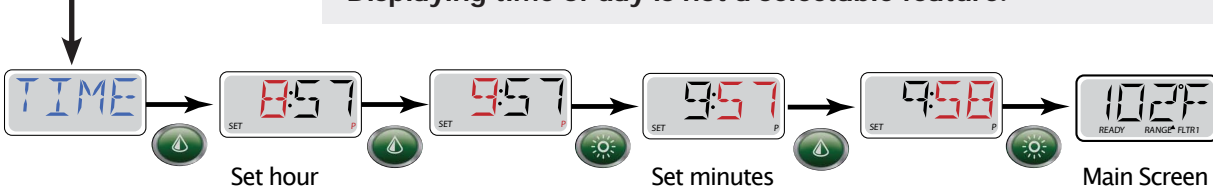

Press  Once
Then Press  3x



Setting the time of day is important for determining filtration times and other background features. 24-hour time display can be set under the PREF menu.

Note: This system does NOT display the time of day. The default display on the Main Screen is the current water temperature. Displaying time of day is not a selectable feature.

Flip (Invert Display)

Press  Once
Then Press  4x

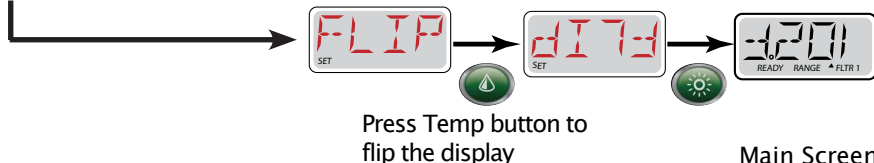

Inverting the display allows you to be able to read the control panel while you are in the spa.

Locking the Control

- Press  Once
- Then Press  5x

The control can be locked to prevent unwanted use or temperature adjustments. You can lock the set temperature or the control panel.

Locking the temperature allows Jets and other features to be used, but the Set Temperature and other programmed settings cannot be adjusted.

Locking the panel prevents the controller from being used, but all automatic functions are still active.

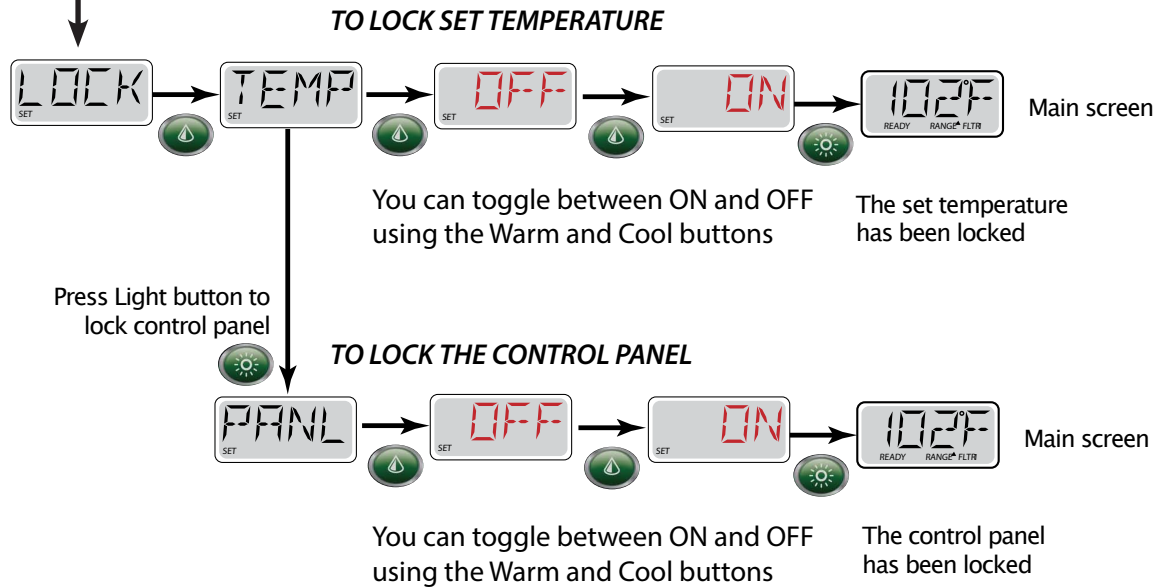

Unlocking the control

While pressing and holding the WARM Button, press the LIGHT button twice.

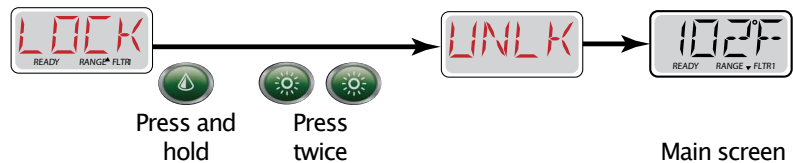

Hold Mode

- Press  Once
- Then Press  6x

Hold Mode is used to disable the pumps during service functions like cleaning or replacing the filter. (See page 38 for instruction on cleaning the filter.)

Hold Mode will last for 1 hour unless the mode is exited manually.



Adjusting Filtration

Press  Once
Then Press  7x

Main Filtration

Filter cycles are set using a duration. Each setting can be adjusted in 15-minute increments. Filter Cycle 1 and Filter Cycle 2 (if enabled) are set to the same duration.

If Filter Cycle 2 is enabled, Filter 2 will appear in the LCD. If Filter 2 is disabled, Filter 1 will appear.

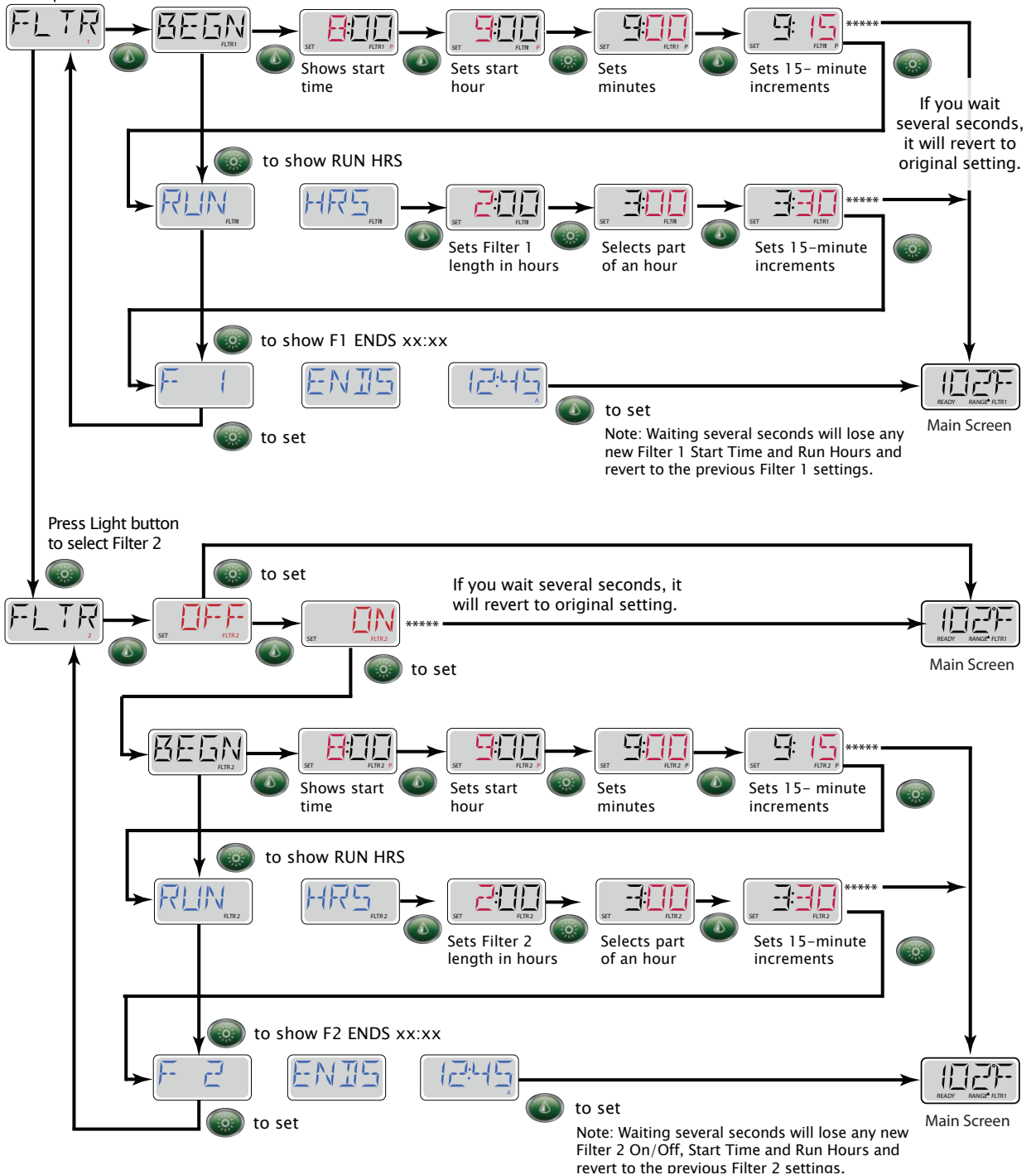

Setting Preferences

Press  Once
 Then Press  9x

This allows you to set the following preferences for system operation:

- Change the temperature between Fahrenheit and Celsius
- Change the clock between 12-hour and 24-hour display
- Turn periodic reminders (like "CLEAN FILTER") on or off

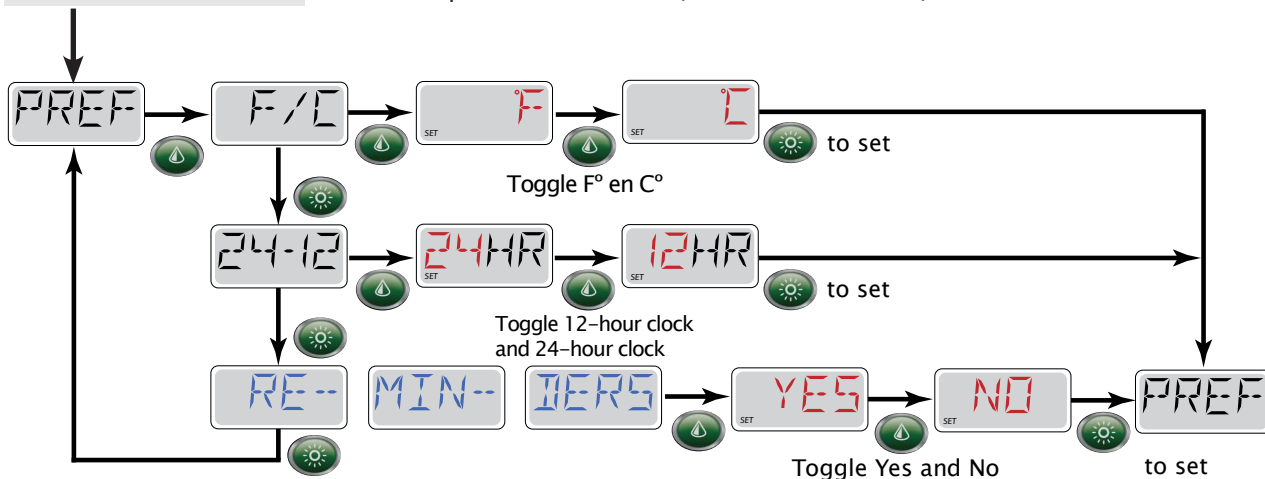

Utilities

This menu feature is for system information only and is used mainly for repair and troubleshooting.

Other Spa Systems

Several spa functions operate in the background and require no action or maintenance from you. This is for your information only.

Pumps

Press the "Jets 1" button once to turn pump 1 on or off, and to shift between low- and high-speeds if equipped. If left running, the pump will turn off after a time-out period. The pump 1 low-speed will time out after 30 minutes. The high-speed will time out after 15 minutes.

On non-circ systems, the low-speed of pump 1 runs when the blower or any other pump is on. If the spa is in Ready Mode, Pump 1 low may also activate for at least 1 minute every 30 minutes to detect the spa temperature (polling) and then to heat to the set temperature if needed. When the low-speed turns on automatically, it cannot be deactivated from the

panel, however the high speed may be started.

Circulation Pump

The circulation pump will come on when the system is checking temperature (polling), during filter cycles, during freeze conditions, or when another pump is on.

The ozonator will run with the circulation pump during filtration cycles.

Purge Cycles

In order to maintain sanitary conditions, secondary Pumps and/or a Blower will purge water from their respective plumbing by running briefly at the beginning of each filter cycle.

Diagnostic Messages

Message	Meaning	Action Required
RUN PMPS PURG AIR	<p>Priming Mode</p> <p>Each time the spa is powered up, it will enter Priming Mode. The purpose of Priming Mode is to allow the user to run each pump and manually verify that the pumps are primed (air is purged) and water is flowing. This typically requires observing the output of each pump separately, and is generally not possible in normal operation.</p>	<p>Priming Mode lasts 4 minutes, but you can exit it earlier by pressing any Temp button. The heater is not allowed to run during Priming Mode.</p> <p>NOTE: If your spa has a Circ Pump, it will turn on with Jets 1 in Priming Mode. The Circ Pump will run by itself when Priming Mode is exited.</p>
---F - ---C	<p>Water Temperature Is Unknown</p> <p>After the pump has been running for 1 minute, the temperature will be displayed.</p>	None
42F TOO COLD	<p>Too Cold - Freeze Protection</p> <p>A potential freeze condition has been detected, or the Aux Freeze Switch has closed, and all pumps and blower are activated. All pumps and blower are ON for at least 4 minutes after the potential freeze condition has ended, or when the aux freeze switch opens. In some cases, pumps may turn on and off and the heater may operate during Freeze Protection.</p>	None.
WATR TOO HOT	<p>Water is Too Hot</p> <p>One of the water temp sensors has detected spa water temp 43.5°C (110°F) and spa functions are disabled.</p>	None. System will auto reset when the spa water temp is below 42°C (108°F). Check for extended pump operation or high ambient temp.
SFTY TRIP ----	<p>Safety Trip - Pump Suction Blockage</p> <p>The Safety Trip error message indicates that the vacuum switch has closed. This occurs when there has been a suction problem or a possible entrapment situation avoided. (Note: not all spas have this feature.)</p>	Drain or filter may be covered, creating a blockage. Clear the blockage and reset by pressing any button on the topside panel.
HTR FLOW LOSS ----	<p>Heater Flow Is Reduced</p> <p>There may not be enough water flow through the heater to carry the heat away from the heating element.</p>	Check for low water level, suction flow restrictions, closed valves, trapped air, too many closed jets and pump prime. Heater start up will begin again after about 1 minute.
HTR FLOW FAIL ----	<p>Heater Flow is Reduced</p> <p>There is not enough water flow through the heater to carry the heat away from the heating element and the heater has been disabled.</p>	Check for low water level, suction flow restrictions, closed valves, trapped air, too many closed jets and pump prime. Heater start up will begin again after about 1 minute.

Message	Meaning	Action Required
HTR MAY BE DRY ---- WAIT ----	Heater May Be Dry Possible dry heater, or not enough water in the heater to start it. The spa is shut down for 15 min.	Check for low water level, suction flow restrictions, closed valves, trapped air, too many closed jets and pump prime. Press any button to reset the heater start-up.
HTR DRY ----	Heater Is Dry There is not enough water in the heater to start it. The spa is shut down.	Check for low water level, suction flow restrictions, closed valves, trapped air, too many closed jets and pump prime. Press any button to reset the heater start-up.
HTR TOO HOT ----	Heater Is Too Hot One of the water temp sensors has detected 48°C (118°F) in the heater and the spa is shut down.	Check for low water level, suction flow restrictions, closed valves, trapped air, too many closed jets and pump prime. Press any button to reset when water is below 42°C (108°F).
PRES BTTN TO RSET ----	Spa Needs To Be Reset This message may appear with other messages.	Press any button on the topside control to reset.
102F SNSR BAL- ANCE	Sensor Balance Is Poor The temperature sensors MAY be out of sync by 1°C or 2°C (2°F or 3°F).	Call for service.
SNSR SYNC ---- CALL FOR SRVC ----	Sensor Balance is Poor The temperature sensors ARE out of sync.	Call for service. Note: This message can be reset from the topside panel with any button press.
SNSR A ---- CALL FOR SRVC SNSR B ---- CALLFOR SRVC	Sensor Failure A temperature sensor or sensor circuit has failed.	Call for service.
NO COMM	No Communications The control panel is not receiving communication from the system.	Call for service.
102°T	°F or °C is replaced by °T The control system is in Test Mode.	Call for service.
STUK PUMP ----	A Pump Appears To Be Stuck ON Water may be overheated.	POWER DOWN THE SPA. DO NOT ENTER THE WATER. Call for service.
HOT FALT ---- CALL FOR SRVC ----	A Pump Appears To Be Stuck ON A pump appears to have been stuck ON when spa was last powered.	POWER DOWN THE SPA. DO NOT ENTER THE WATER. Call for service.

TP800 Control Panel Operation



The Main Screen

Spa Status

When the spa has finished priming, you will see the Main Screen. Important information about spa operation can be seen quickly from the Main Screen. The most important features can be accessed from this screen.

- The actual water temperature can be seen in large text and the desired, or Set Temperature, can be selected and adjusted.
- Time-of-day, ozone operation and filter operation status are shown, along with other messages and alerts.
- Temperature Range (High or Low) is indicated in the upper right corner.
- A Lock icon is visible if the panel or settings are locked.

Setting Your Language Preference

You can set the TP800 control panel to one of six languages: English, French, Spanish, German, Italian, and Czech.

On the main screen, select **Settings**, then scroll down to **Preferences**, and then select Language.

After you have made your selection, return to Preferences and select **Temp Display** to change the temperature display from Fahrenheit to Celsius.

After you have done this, return to the main menu.

The examples shown in this manual assume you have selected English as your language preference.

Navigation

There are four selections you can make on the Main Screen:

Set temperature - Press the left arrow button to change the Set Temperature number to white. The Set Temperature can then be adjusted with the up and down buttons. Pressing the Select button or the Right Arrow button will save the new set temperature.

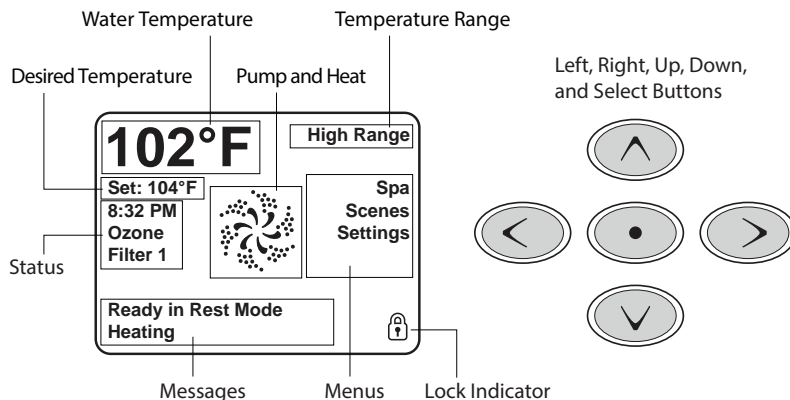

Menu selections - The three menu choices on the right, **Spa**, **Shortcuts**, and **Settings**, can be selected and the screen will change to show more detailed controls or programming functions. They will be discussed further in this section.

Messages

At the bottom of the screen, messages may appear at various times. Some of these messages must be dismissed by the user (see page 29).

Spa Screen

The Spa Screen shows all available equipment to control, as well as other features, like Invert, in one easy-to-navigate screen. The display shows icons that are related to the equipment installed on a particular spa model, so this screen may change depending on the installation.

The navigation buttons are used to select an individual device. The device that is chosen is highlighted with a white outline and the text under the icon changes to white. Once a device is selected, it can be controlled using the center Select Button.

Some devices, like pumps, may have more than one ON state, so the icon will change to reflect the state that the equipment is in. Below are some examples of 2-speed Pump indicators.

If the Spa has a Circ Pump, a Circ Pump Icon will appear to indicate its activity, but outside of Priming Mode, the Circ Pump cannot be controlled directly. NOTE: The icon for the pump that is associated with the heater (Circ or P1 Low) will have a red glow in the center when the heater is running.

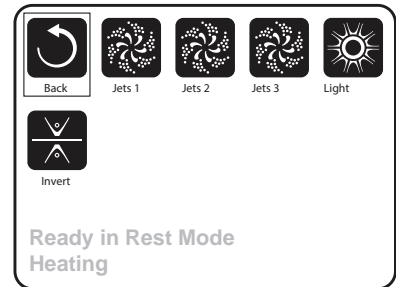

Settings Screen

The Settings Screen is where all programming and other spa behaviors are controlled.

This screen has several features that can be acted on directly. These features include Temp Range, Heat Mode, and Invert Panel. When one of these items is highlighted, the Select Button is used to toggle between two settings. All other menu items (with an arrow pointing to the right) go to another level in the menu.

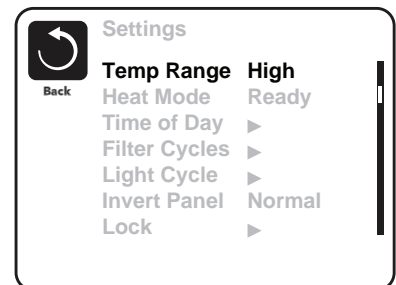

Setting Time of Day

Setting the time of day is important for determining filtration times and other background features. "Set Time" will appear on the Main Screen if no time of day is set.

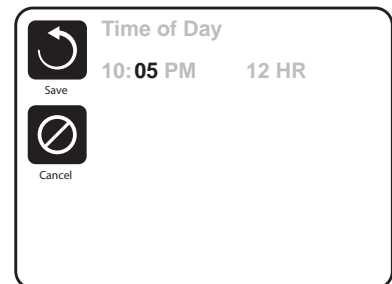

Setting Dual Temperature Ranges

This system incorporates two temperature range settings with independent set temperatures. The specific range can be selected on the Settings screen and is visible on the Main Screen in the upper right corner of the display.

These ranges can be used for various reasons, with a common use being a “ready to use” setting vs. a “vacation” setting. Each range maintains its own set temperature as programmed by the user. This way, when a range is chosen, the spa will heat to the set temperature associated with that range.

High Range can be set between 26.5°C and 40°C (80°F and 104°F). Low Range can be set between 10°C and 37°C (50°F and 99°F). More specific Temp Ranges may be determined by the Manufacturer. Freeze Protection is active in either range.

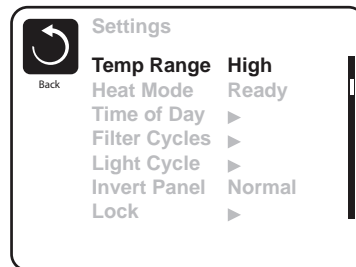

Selecting Heat Modes – Ready vs. Rest

In order for the spa to heat, a pump needs to circulate water through the heater. The pump that performs this function is known as the “heater pump.”

The heater pump can be either a 2-speed pump (Pump 1) or a circulation pump. If the heater pump is a 2-Speed Pump 1, Ready Mode will circulate water every 1/2 hour, using Pump 1 Low, in order to maintain a constant water temperature, heat as needed, and refresh the temperature display. This is known as “polling.”

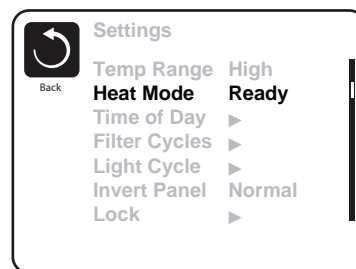

Rest Mode will only allow heating during programmed filter cycles. Since polling does not occur, the temperature display may not show a current temperature until the heater pump has been running for a minute or two. While Pump 1 High can be turned on and off, Pump 1 Low will run until set temperature is reached, or 1 hour has passed.

Circulation Mode

If the spa is configured for 24HR circulation, the heater pump generally runs continuously. Since the heater pump is always running, the spa will maintain set temperature and heat as needed in Ready Mode, without polling. In Rest Mode, the spa will only heat to set temperature during programmed filter times, even though the water is being filtered constantly when in Circulation Mode.

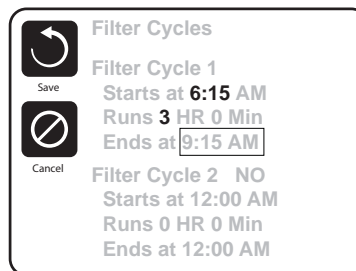
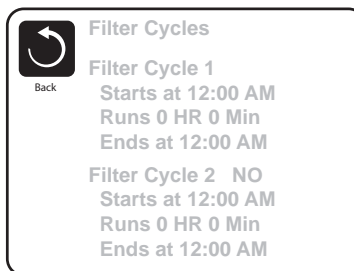

Ready-in-Rest Mode

READY/REST appears in the display if the spa is in Rest Mode and the Jets 1 Button is pressed. It is assumed that the spa is being used and will heat to set temperature. While Pump 1 High can be turned on and off, Pump 1 Low will run until set temperature is reached, or 1 hour has passed. After 1 hour, the System will revert to Rest Mode. This mode can also be reset by entering the Settings Menu and changing the Heat Mode.

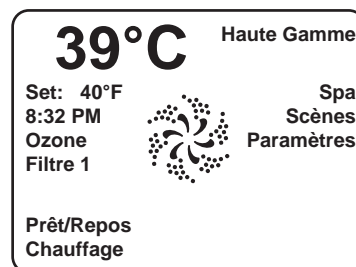

Setting Filter Cycles

Filter cycles are set using a start time and a duration. Each setting can be adjusted in 15-minute increments. The panel calculates the end time and displays it automatically.

Filter cycle 2 is off by default, but can be selected for use if desired.

Locking and Unlocking the Control Panel

The control can be restricted to prevent unwanted use or temperature adjustments.

Locking the Settings allows jets and other features to be used, but the set temperature and other programmed settings cannot be adjusted.

When settings are locked, there is a reduced selection of menu items. These include Set Temperature, Invert, Lock, Utilities, Information and Fault Log. They can be seen, but not changed or edited.

Locking the Panel prevents the controller from being used, but all automatic functions are still active.

Locking and Unlocking -- Use the navigation buttons from the Lock Screen. The Lock and Unlock Sequence is the same for both Panel Lock and Settings Lock.

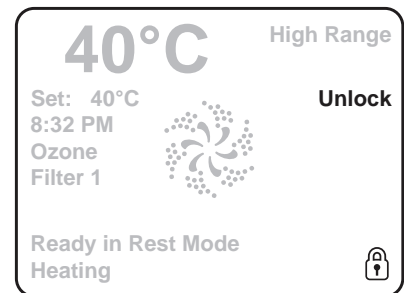
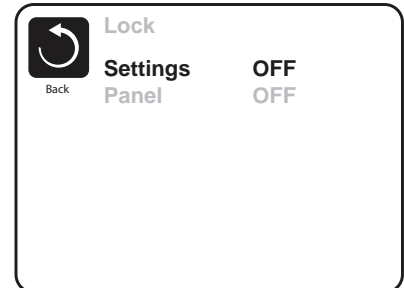
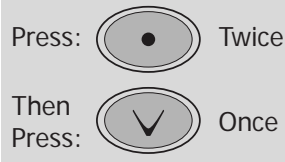

Additional Settings

Light Cycle

If Light Cycle does not appear in the Settings Menu, the light timer feature is not enabled by the manufacturer. When available, the light timer is OFF by default. The settings can be edited the same way as filter cycles.

Invert Panel

Selecting Invert Panel will flip the display and the buttons so the panel can be easily operated from inside or outside the hot tub.

Hold

Hold Mode is used to disable the pumps during service functions like cleaning or replacing the filter. (See page 38 for instruction on cleaning the filter.)

Hold Mode will last for 1 hour unless the mode is exited manually.

Utilities

This menu feature is for system information only and is used mainly for repair and troubleshooting.

Preferences

This allows you to set the following preferences for system operation:

- Change the language on the control panel
- Change the temperature between Fahrenheit and Celsius
- Change the clock between 12-hour and 24-hour display
- Turn periodic reminded (like "CLEAN FILTER") on or off

Information

This menu feature is for system information only and is used mainly for repair and troubleshooting.

Diagnostic Messages

Message	Meaning
---F - ---C	Water temperature is unknown. After the pump has been running for one minute, the temperature will be displayed.
Possible freezing condition	A potential freeze condition has been detected, or the Aux Freeze Switch has closed. All water devices are activated. In some cases, pumps may turn on and off and the heater may operate during Freeze Protection. This is an operational message, not an error indication.
The water is too hot	The system has detected a spa water temp of 43.5°C (110°F) or more, and spa functions are disabled. System will auto reset when the spa water temp is below 42°C (108°F). Check for extended pump operation or high ambient temp.
Water flow is low	There may not be enough water flow through the heater to carry the heat away from the heating element. Heater start up will begin again after about 1 min. See "Flow Related Checks" below.
Water flow has failed	There is not enough water flow through the heater to carry the heat away from the heating element and the heater has been disabled. See "Flow Related Checks" below. After the problem has been resolved, you must press any button to reset and begin heater start up.
The heater may be dry	Possible dry heater, or not enough water in the heater to start it. The spa is shut down for 15 min. Press any button to reset the heater start-up. See "Flow Related Checks" below.
The heater is dry	There is not enough water in the heater to start it. The spa is shut down. After the problem has been resolved, you must clear the message to restart heater start up. See "Flow Related Checks" below.
The heater is too hot	One of the water temp sensors has detected 48°C (118°F) in the heater and the spa is shut down. You must clear the message when water is below 42°C (108°F). See "Flow Related Checks" below.
Sensors are out of sync	The temperature sensors MAY be out of sync by 1°C or 2°C (2°F or 3°F). Call for service.
Sensors are out of sync -- Call for service	The temperature sensors ARE out of sync. The fault above has been established for at least 1 hour. Call for service.
Sensor A Fault, Sensor B Fault	A temperature sensor or sensor circuit has failed. Call for service.
Communications error	The control panel is not receiving communication from the System. Call for service.
°F or °C is replaced by °T	The Control System is in Test Mode. Call for service.

Flow-Related Checks

Check for low water level, suction flow restrictions, closed valves, trapped air, too many closed jets and pump prime. On some systems, even when spa is shut down by an error condition, some equipment may occasionally turn on to continue monitoring temperature or if freeze protection is needed.

Cal Spas Hot Tub WiFi App

This optional feature is available for use with any smart device (Android™ or iPhone™). You must have the wifi module installed in your spa in order to use the app.

This feature is only available for spas with the BP501 or BP2000 control box.

1 Stand-alone app

Range: About 20 feet
Range limit: Limited to the range of the wi-fi module



HOW TO CONNECT TO IT:

Install the app on your phone or device -- see the following section "Installing the app".

2 App with home network, no internet access

Range: About 50 feet
Range limit: Limited to the range of your home router's signal



HOW TO CONNECT TO IT:

Install the app on your phone or device -- see the following section "Installing the app".

3 App with home network with internet access, using Cloud connection or other hotspot connection

Range: Worldwide
Range limit: Limited to 3G / 4G / hotspot availability

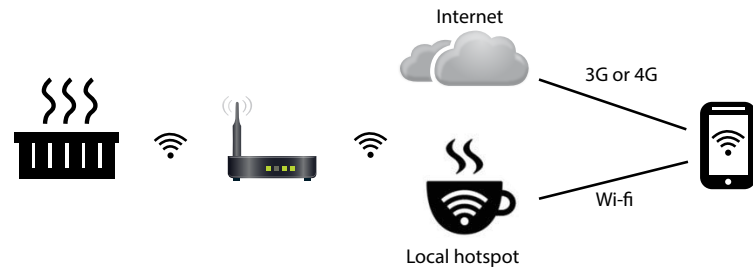

HOW TO CONNECT TO IT:

1. Install the app on your phone or device -- see the following section "Installing the app".
2. Exit the app and go to wi-fi settings on your phone.
3. Select and enable your local router.
4. Start the app. After you connect, select Settings on the home screen.
5. On the Settings screen, select Advanced, then on the Advanced screen, select Wi-fi Settings.
6. On the Wi-fi screen, select WPA. Then select the name of your home route from the drop-down menu.
7. Enter the SSID and Key for your router, the tap Save and select OK twice.
8. Close the app and re-start it to connect to your home network.

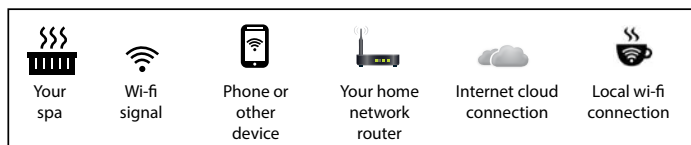

If you have any trouble connecting, go to www.balboawatergroup.com/bwa and download the PDF document "Setting Up Your Wi-fi".

Installing the app

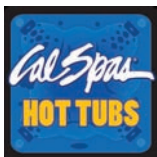

Go to the Apple app store or Google Play and search for the free spa app using the key words "Cal Spas Hot Tub." Select the app. The icon for the app will appear on your device as shown at left.

Make sure you enable wifi on your phone before you run the app.

On the wi-fi connections screen on your device, a network will appear called "BWGSpa_XXXXXX_". (The x's represent the wi-fi module's local address and is unique for every spa.) Once you are connected to the BWG Spa network, start the bwa app and follow the prompts on the screen. (Your start screen maybe different.)

1. Press the app button on the main screen of your device.
2. Connect to the spa's wifi signal.
3. When connected, you will be taken to the main app screen.
4. You are now directly connected to your hot tub and can control all the hot tub functions via the app.



Using the app

When the app has been installed, it will provide you with instant access and control of your spa wherever you connect within the spa's Wi-Fi range.

The controls are visually oriented and require little explanation. You can find more in-depth instructions in the Wi-Fi Setup Guide at the Balboa web site:

<http://www.balboawatergroup.com/bwa>

Troubleshooting connection problems

You should have few problems connecting with the bwa wifi app. However, if you are unable to connect quickly and easily to the spa's wifi source, try doing the following.

- Enable on your device. This is the most likely reason you may not be able to connect to the app. Check your devices wifi settings and try connecting again.
- Power cycle the spa. Shut off power to the spa for 30 second and turn it back on. Wait until the spa has gone through its complete set-up routine before you try to connect with the wifi app.
- Wait until the spa has completely primed. When you turn on the spa, it will go through a priming routine, which is followed by temperature polling, where no temperature is shown on the control panel. As soon as a temperature appears, you can connect with the wifi app.
- If you use your home network router, it **MUST** be close enough to the spa in order for the spa's wi-fi signal to reach the router. If you have connectivity problems, you may need to relocate your router closer to your spa or consider adding a wireless signal booster to your router.

Electrical Power Efficiency

Your new spa comes equipped with an electric heater. Following the directions listed below will ensure the most efficient operation:

NOTE: This method is only for spa usage under two hours a week.

- Keep the spa's operating temperature 3°C (5°F) below the desired usage temperature when not in use. One or two hours before use, set the temperature to the desired temperature.
- If the spa usage exceeds two hours a week, the set temperature should remain at the desired usage temperature.
- The air venturis should be used sparingly. When open, water temperature drops quite rapidly and can also dissipate chemicals.

Allowing the water temperature to lower more than 5.5°C (10°F) below the desired usage temperature and reheating it prior to usage will cause the heater to operate longer than it normally would maintaining the desired temperature. Doing this will increase your operating cost and makes your heater work more than necessary.

Adjustable Jets

Almost all of the jets in your spa are adjustable. Rotating the face of an adjustable jet to the left (counter-clockwise) will decrease the amount of water flow through the jet. Rotating the face of an adjustable jet to the right (clockwise) will increase the amount of water flow through the jet. (See example shown below.)

Neck jets adjust in the opposite directions (counter-clockwise to increase, clockwise to decrease).



LED Perimeter Lighting

Press the LIGHT button on the topside control panel to turn the spa light on. If your spa has perimeter LED lights, they will also light up at the same time as the spa light.

The perimeter lights operate in three modes:

1. **Cycle:** The first time you press the LIGHT button, the lights will cycle through all the colors in this order:

White
Cyan
Magenta
Blue
Yellow/green
Green
Red

To cycle through the different color choices, press the button repeatedly. Each time you press the button, you advance to the next color.

2. **Flashing white:** When you have cycled through all the colors, the next time you push the LIGHT button, the LED lights will flash white.
3. **Fading cycle:** The next time you push the LIGHT button, the lights will gradually fade from one color to the next in the order shown above.

Spas with exterior corner LED lighting work in the same modes as described above but do not light up when the interior perimeter lights are yellow/green, green or red.

Diverter Knobs

Diverter knobs are the larger knobs located around the top of your spa. They allow you to divert water through jets from one side of the spa to the other, or in most cases from floor jets to wall jets. This is accomplished by rotating the diverter knob to the left (counterclockwise), decreasing the amount of water flow through a section of jets. To increase the amount of water flow through the other section of jets, rotate the handle to the right (clockwise).



Waterfalls

Some spa series include optional waterfalls. When the booster pump is on, turn the knob near the waterfall. Water will immediately start flowing through it.



Air Venturis

Air venturis are the smaller knobs located around the top of your spa. Each one will let you add a mixture of air with the jet pressure. This is accomplished by rotating the air venturi knob to the left (counterclockwise) to increase the amount of airflow through the jets. To decrease the amount of airflow through the jets, rotate the handle to the right (clockwise).



Hydro Streamer Waterfall

Your spa may include two to eight streamer waterfalls. When the booster pump is on, turn the 1" diverter knob to adjust the rate of flow to the waterfall jets.

The waterfall jet faces are not adjustable. Do not turn the jet faces because you may accidentally remove them.

Always shut off water to the hydro streamer jets before you place the cover on the spa. Water from the hydro streamer jets sprays in an arc that is higher than the top surface of the spa. When water from the hydro streamer sprays the bottom of the cover, it will collect and run to the edge of the spa and drip over the top.



Adjustable Therapy System

Pump On / Off Button

Press this button once to turn on the ATS pump. The POWER ON light on the control panel will appear. Press this button a second time to turn off the ATS pump. The ATS pump must be on before you can use any other features of this system.

Pulse Mode Button

Press this button once to turn on the Pulse Mode. The first time it is pressed, the orange LED in position number 1 will light, indicating the number one pulse mode. Each press of either the **Up** or **Down** button will move the orange LED up or down to the next pulse mode. Allow one second between each button press. Pressing the button quickly may cause improper operation. To turn the Pulse Mode off and return to normal pump operation, press the **Pulse Mode** button a second time.



Up / Down Buttons

These buttons allow you to cycle through seven massage modes. Each mode offers a different pulsating massage. Some modes are faster than others, so just cycle through them to find the massage you like best.

Time Reset

Pulse Mode will normally run for 15 minutes then automatically shut off. For another 15-minute session, press the **Pump On / Off** button and the **Pulse Mode** button. A light will blink and the pump will run on high-speed mode as part of a 15-minute cool down period. After that, the pump will stop automatically and the LED light on the panel will continue to blink for one minute then shut off automatically. After the second 15-minute session, the system will run through a cool down cycle for up to two hours. In this cool down mode, the you will only be able to operate the pump (by again pressing the **Pump On / Off** button). However, the massage mode will remain off until the cool down mode is completed.

Resetting Pulse Mode

Pulse Mode will shut off for two hours unless reset. During this time the pump will run at a maximum speed. To reset Pulse Mode, press the **Pump On / Off**

to turn off the ATS pump, the press the **Pulse Mode** button once. The power light will flash to indicate Pulse Mode has been reset.

- 7 Gentle & powerful alternating bursts
- 6 Quick powerful, continuous bursts
- 5 3 gentle bursts followed by 1 vigorous burst
- 4 Swift rolling bursts
- 3 Accelerated continuous bursts
- 2 Medium continuous burst
- 1 Low rolling bursts

VariMax System

This feature is available with Velocity spas only.

The VariMax system offers a wide range of speeds. The control can be set to a continuous high speed or low speed, or in between.

The VariMax system also has a Wave Mode that automatically ramps from high speed to low speed, then back up to high speed. It then repeats.

Press the **ON / OFF / WAVE** button to turn it on. The LED will appear when the pump is on.

To manually control the speed control, press the **ON / OFF / WAVE** button to turn on the VariMax system and press the **SPEED UP** or **SPEED DOWN** buttons to change the speed.



Water Clarity

This section is intended for new spa owners with no experience with water chemistry. Everyone's experience with maintaining water quality is different, but there are some general concepts you need to know.

Water maintenance is not difficult, although it requires regular attention. The most important thing to understand about taking care of your spa water is that preventive action is much easier than correcting water quality issues.

The Key to Clear Water

Excellent water quality is a simple matter of four things:

Chemical Balance

You will need to test and adjust the chemical balance of your spa water. Although this is not difficult, it needs to be done regularly.

Depending on your choice of sanitizer, you need to test the level of calcium hardness, total alkalinity, and pH. Spa owners with a Cal Clarity II bromine generator also need to check total dissolved solids and phosphates.

See page 36 to learn how to balance your spa water.

Sanitation

Sanitizers kill bacteria and viruses and keep the water clean. A low sanitizer level will allow microbes to grow quickly in the spa water. We recommend using either chlorine or bromine as your sanitizer.

Spa owners with an ozonator also need to add sanitizer, although their requirements are different.

See page 37 to learn how to use sanitizer.

The Cal Clarity II bromine generator does NOT require sanitizer. See page 40 for a description of its use.

Filtration

Cleaning your filter regularly is the easiest and most effective single thing you can do to keep your water clear.

A clogged or dirty filter will cause the heater and pump to work harder than they need to, possibly causing them to fail.

The spa's heating system will only function with the proper amount of water flow through the system.

See page 38 for filter cleaning instructions.

Regularity

Clear water requires regular maintenance. Establish a routine based on a regular schedule for your spa water maintenance.

Maintaining your water quality helps the enjoyment of your spa and extends your spa's life by preventing damage from neglect and chemical abuse.

See page 42 for the schedule of recommended maintenance.



Testing and Adjusting Spa Water

You have two types of testing methods to choose from:

- **The reagent test kit** is a method which provides a high level of accuracy. It is available in either liquid or tablet form.
- **Test strips** are a convenient testing method commonly used by spa owners.

Balancing the Total Alkalinity

Total alkalinity (TA) is the measure of the total levels of carbonates, bicarbonates, hydroxides, and other alkaline substances in the water. TA can be considered a "pH buffer". It is the measure of the ability of the water to resist changes in pH level.

The recommended total alkalinity is 80 - 120 ppm.

If the TA is too low, the pH level will fluctuate widely from high to low. Low TA can be corrected by adding an alkalinity increaser

If the TA is too high, the pH level will tend to be too high and may be difficult to bring down. High TA can be corrected by adding an alkalinity decreaser.

When the TA is balanced, it normally remains stable, although adding water with high or low alkalinity will raise or lower the TA level.

Balancing the Calcium Hardness

Calcium hardness (CH) is a measure of the total amount of dissolved calcium in the water. Calcium helps control the corrosive nature of the spa's water and is why soft water is not recommended. The low calcium content of soft water is very corrosive to the equipment and can cause staining of the spa shell.

The recommended calcium hardness is 150 - 200 ppm.

If the CH is too low, add a calcium hardness increaser.

If the CH is too high, dilute the spa water with soft water.

When the CH is balanced, it normally remains stable, although adding soft water or very hard water will raise or lower the CH level.

Balancing the pH

The pH level is the measure of the balance between acidity and alkalinity.

If the pH is too low, it can cause corrosion of metal fixtures and the heating element. Low pH can be corrected by adding a pH decreaser.

If the pH is too high, it can cause scaling by allowing metals or minerals to form deposits and stain spa surfaces. High pH can be corrected by adding a pH increaser

Ideal Water Chemistry

Testing For:	Ideal Range (ppm)	
	Minimum	Maximum
Total Alkalinity	80	120
Calcium Hardness	150	200
pH	7.2	7.6

Sanitation

Sanitizers kill bacteria and other organic waste by breaking them down to non-harmful levels and are filtered out. Before you fill your spa, you need to decide which chemical sanitizer you wish to use. Consult your Cal Spas dealer for the right decision with regards to your lifestyle and spa usage.

Do not use a sanitizer with the Cal Clarity II bromine generator. See page 40 for instructions on its use.

We recommend either **bromine** or **chlorine** as your sanitizer. Both work well when maintained regularly.



DO NOT use trichlor. Trichlor is very acidic and the hot temperature of the spa causes it to dissolve too quickly. It will cause damage to your spa and will void your warranty.

Whichever plan you decide on, follow it completely and don't take shortcuts. It will provide you with clean, safe, clear spa water with a minimum of effort. Spa owners with an ozonator still need to use a chemical sanitizer. See page 39 for a description of how the ozonator works.

Using Chlorine as a Sanitizer

If you choose to use chlorine as a sanitizer, only use granulated chlorine, not liquid chlorine.

Once a week, check the chlorine level using either a test strip or a reagent kit. See the table on the following page for the ideal range.

Add one or two tablespoons granulated chlorine to the spa water weekly. Note that chlorine dissipation rate will be faster at higher water temperatures and slower at lower temperatures.

When you add chlorine, open all of the jets and run the spa at high speed with the cover open for at least 30 minutes.

Follow the maintenance schedule on page 42.

Using Bromine as a Sanitizer

Bromine is a very effective sanitizer that produces low chemical odors. Unlike chlorine, it can break down bacteria and other impurities to a safe level with a low burn-out rate.

Bromine is available in both granulated and tablet form. Use granulated sodium bromide to establish your bromine base. Use tablets to maintain it.

When you begin with fresh water, add 2 ounces of granulated bromide. Open all of the jets and run the spa at high speed with the cover open for at least 30 minutes. This is your base bromine level as the tablets will take a while to dissolve.

Place three or four bromine tablets in your chemical floater.

Follow the maintenance schedule on page 42.

Shocking the Water

In addition to using a chemical sanitizer, you will periodically need to shock the water. Shocking the water helps remove burned-out chemicals, bacteria, and other organic material from your spa's water and improves your sanitizer's effectiveness.

Do not use chlorinating shock, which will damage your spa's jets and pump seals. Only use an oxidizer shock. It can be used with either chlorine or bromine sanitizers.

Add one ounce of oxidizer shock once a week, after heavy bather loads, or if water has a strong odor.

Spa must be running with all of the jets on high for 30 minutes with the cover open. If necessary, repeat oxidizer shock in 30 minute intervals.

Do not use shock with the Cal Clarity II bromine generator. See page 40 for instructions on its use.

Testing For:	Ideal Range (ppm)	
	Minimum	Maximum
Chlorine level		
Without ozonator	3.0	5.0
With ozonator	2.0	4.0
Bromine level		
Without ozonator	6.7	11.0
With ozonator	5.7	10.0

Bather Load

“Bather Load” is the term used to describe the number of people using a spa, combined with the length of usage, and the frequency of usage. All these factors have a great effect on the spa water. The higher the bather load, the more chemicals need to be added and a longer filtration time will be needed.

Recommendations are designed for spas with average bather load (3 to 4 people, 15 minutes of usage, three times a week at 100 degrees) If your bather load exceeds these guidelines, and you experience water quality problems, increase the amount of filtration first, (go to the next higher filtration number) then if water quality is still not adequate, consult the advice of your Cal Spas dealer for additional chemical or system recommendations. Be sure to give them your bather load information.

Filter Cleaning

The filter is the part of your spa that removes the debris from the water and needs to be cleaned on a regular basis to maximize your spa’s filtering performance and heating efficiency.

In addition to spraying off the filter weekly to remove surface debris, your filter should be deep cleaned periodically to dissolve scale and particles that get lodged deep within the filter fibers and impede the filtration process. Even if the filter looks clean, scale and particles can clog the fibers and prevent water from flowing through the filter resulting in the most common spa problem—no heat, caused by a dirty filter.

We recommend you clean your filter once a month and replace it once a year or as necessary.

It is extremely important that you never run the spa without a filter. There is a possibility that debris may be sucked into the plumbing through the filter well.

Set the spa in Hold Mode before you remove the filter. Hold Mode pauses all spa operations for 60 minutes for service functions like cleaning or replacing the filter. See page 19 or page 28 for instructions on using Hold Mode.

Cleaning the filter

1. Remove the filter by unscrewing it and pulling it up and out.
2. Place the dirty filter into a bucket of water deep enough to cover the filter. Add 8 oz of liquid filter cleaner to the bucket of water.

Note: It is a good idea to keep a spare filter to use in the spa while the dirty filter is being deep cleaned. This way, you can rotate the filters and both will last longer.

3. Soak the filter for a minimum of 24 hours.
4. Spray the filter with a water hose. Spray each pleat carefully.
5. Reinstall the filter. Do not overtighten.

Pure Cure™ Water Sanitizer

The Pure Cure™ water sanitizer is an optional water purification system installed at the factory. It eradicates germs in the water that are resistant to chlorine-based chemicals using high intensity UV light. Although the water sanitizer works automatically with your spa, you will still need to test for chlorine or bromine and occasionally replenish it to return the sanitizer level to the baseline.

For spas without a circulation pump, pump 1 will run at low speed and the water sanitizer will run during filtration.

For spas with a circulation pump, the water sanitizer will run with the circulation pump.

The spa's control system is factory-programmed with one filter cycle that will run in the evening when energy rates are often lower. The time and duration of the filter cycle can be set according to your needs. In addition, a second filter cycle can be enabled. Filtration time may need to be increased with heavy bather load.

See instructions for setting filtration cycles on page 20 or page 28.

The water sanitizer is virtually maintenance-free. Once a year the UV light needs to be replaced. See page 48 for instructions. **However, the water sanitizer is not a user-serviceable item and maintenance must be performed by a spa technician. Have your service technician consult the manufacturer's instruction and service manual.**

Ozonator

The ozone generator releases ozone into the spa water. You will still need to test for chlorine or bromine and occasionally replenish it to return the sanitizer level to the baseline.

For spas without a circulation pump, pump 1 will run at low speed and the ozonator will run during filtration.

For spas with a circulation pump, the ozonator will run with the circulation pump.

The spa's control system is factory-programmed with one filter cycle that will run in the evening when energy rates are often lower. The time and duration of the filter cycle can be set according to your needs. In addition, a second filter cycle can be enabled. Filtration time may need to be increased with heavy bather load.

See instructions for setting filtration cycles on page 20 or page 28.

Cal Clarity II Bromine Generator

The Cal Clarity II bromine generator automatically generates and releases free bromine into the spa water. You will still need to test for bromine and occasionally adjust it to return the bromine level to the baseline.

Starting the Spa with Fresh Water

This applies to spa owners with the Cal Clarity II bromine generator **ONLY**.

Prior to filling a spa for the first time, or after a routine draining, you will want to follow this start-up plan to extend water life and performance.

1. Fill the spa to the proper water level with normal tap water. (Do not use soft water.) **See page 12 for filling instructions.**
2. Turn on the spa and allow it to prime. **See page 14 for priming instructions.**
3. Turn on the jets.
4. Press the **Boost** button to turn on the Cal Clarity II system. The red ON light should appear steady. If it blinks, make sure the jets are running.
5. Press and hold the **Prog** button for two seconds. When the flashing number appears, press the **Prog** button a second time. An animation will appear, then a number showing the total dissolved solids (TDS) level will be shown.
6. Add BromiCharge™ to the spa water. Use the table below to determine how much you should use.
7. Let the spa run for 15 minutes. Leave it uncovered during this time.

Spa Capacity		Amount of BromiCharge™	
Gallons	Liters	Pounds	Kilograms
300	1135	3.6	1.6
400	1515	4.8	2.2
450	1700	5.4	2.5
500	1890	6	2.7

Use 1.2 lbs. per 100 gallons, or .5 kg per 378 liters.

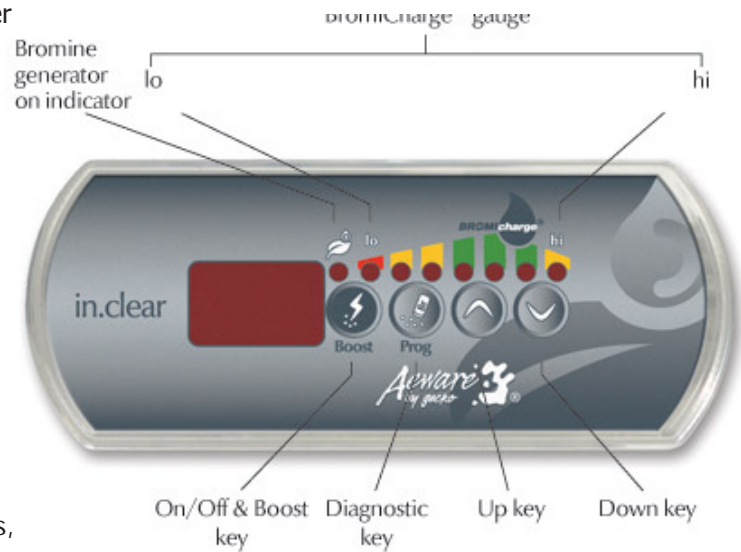

8. Check the TDS level again (described in step 5).
9. Set the Maintenance level. Press and hold the **Prog** button for two seconds. A number will flash showing the Maintenance Mode bromine level. Press the **UP** or **DOWN** buttons to raise or lower it. Press the **Boost** button to return Maintenance Mode.

Use the table below to determine which level to start at.

Spa capacity		Maintenance level
Gallons	Liters	
300 - 400	1135 - 1515	10
400 - 500	1515 - 1890	15
> 500	> 1890	20

10. Put cover on spa and let spa run for 24 hours to allow it to heat to desired temperature.
11. After 24 hours, check TDS level again (as described in step 5). TDS should be between 3 - 5 ppm. If it is too low, raise it in increments of 5 (as described in step 9).

Cal Clarity II Settings

Before entering the spa, the bromine level should be tested. The bromine generator can only produce bromine when:

- the spa is running,
- Bromicharge™ has been added, and
- the bromine generator is in the proper mode.

1. ON / Maintenance Mode

Press the **Boost** button briefly while the jets are running. The system will activate in Maintenance Mode and the word **ON** will appear on the display.

2. Adjusting the Maintenance Mode

To adjust the Maintenance Mode bromine level, press and hold the **Prog** button for two seconds. A number will flash showing the Maintenance Mode bromine level. Press the **UP** or **DOWN** buttons to raise or lower it. After seven seconds, the number will stop flashing, meaning the bromine level is active. Press the **Boost** button to return Maintenance Mode.

3. Boost Mode

The Boost Mode is used each time you use the spa. Press the **Boost** button once to activate the Boost Mode. A number with a dash before and after it will flash for about five seconds showing the boost level. This number corresponds to the number of bathers. While the number is flashing, press the **UP** or **DOWN** buttons to raise or lower it. When the number stops flashing, the system will remain in Boost Mode.

4. Using the Diagnostic Mode

Press and hold the **Prog** button for two seconds. When the flashing number appears, press the **Prog** button a second time. An animation will appear, and within 10 seconds the TDS level will be shown.

5. Turning OFF

Press and hold the **Boost** button for two seconds. The system will shut off and the word **OFF** will appear on the display.

Adding BromiCharge™ to the Water

BromiCharge™ is the chemical additive used with the Cal Clarity II. It can be added anywhere in the spa by simply pouring it from the container. Do not breathe or get into your eyes.

Operating Modes

Maintenance Mode

Maintenance Mode is the “everyday” mode and is automatically on when the system is activated. Its primary function is to keep the bromine level at a stable and acceptable range when the spa is not being used.

Boost Mode

Use the Boost Mode each time you use the spa. Boost Mode increases the bromine generation rate to attack pollutants in the water. Activating the Boost Mode when you enter the spa will prevent inadequate bromine levels and will regenerate your bromine to the proper residual level.

Diagnostic Mode

The Diagnostic Mode indicates the BromiCharge™ salt level of your spa. This is a useful tool when adding BromiCharge™ to the water. Keep the TDS level indicators in the green zone and value between 11 and 14 for optimal performance.

Testing the Water

In addition to testing the water for levels of calcium, alkalinity, and pH, you also need to test for bromine and total dissolved solids (TDS).

See page 36 for instructions on testing the water and for Ideal Water Chemistry levels.

The bromine level should be maintained between 3-5 ppm and can be tested with a DPD test kit, or bromine test strips, found at any spa/pool store.

If the bromine generator does not produce enough bromine, make sure the recommended level of 1440 ppm of BromiCharge™ salt is still present in the spa water. The bromine generator can test the water using the Diagnostic mode. This is described in the “Operating Modes” section above.

If the bromine level is too high, remove a small amount of spa water until the bromine level is between 3-5 ppm. For more immediate results, dilution with fresh water will lower the bromine level.

	Ideal Range	
	Minimum	Maximum
BromiCharge™ (ppm)	1300	1600
Bromine (ppm)	3	5
TDS level	11	14

Maintenance Schedule

Each time you refill the spa	Follow the section "Filling and Powering Up Your Portable Spa" on page 12.
Prior to each use	Test the spa water using either test strips a reagent test kit. Adjust chemical levels as necessary.
Once a week	Test the spa water using either test strips a reagent test kit. Adjust chemical levels as necessary. If your water source is high in calcium, add stain and scale preventer.
Once a month	Deep clean your spa's filter. (Follow filter cleaning instruction at beginning of this section)
Every two to four months	Change the spa water. How often you change the water depends on how much you use the spa. When you change the water, you will need to: <ul style="list-style-type: none"> • Clean and polish the acrylic surface (see page 47) • Clean and treat the spa cover and pillows (see page 44) • Deep clean the filter (see page 38) • Refill your spa (see page 12)
Once a year	Replace filter cartridges if the pleats appear frayed. If you use the Cal Pure UV water sanitizer, you will need to replace the UV lamp (see page 48 for UV lamp maintenance)

Troubleshooting Water Clarity Problems

Problem	Probable Causes	Possible Solutions
Cloudy Water	<ul style="list-style-type: none"> • Dirty filter • Excessive oils / organic matter • Improper sanitization • Suspended particles / organic matter • Overused or old water 	<ul style="list-style-type: none"> • Clean filter • Shock spa with sanitizer • Add sanitizer • Adjust pH and/or alkalinity to recommended range • Run jet pump and clean filter • Drain and refill the spa
Water Odor	<ul style="list-style-type: none"> • Excessive organics in water • Improper sanitization • Low pH 	<ul style="list-style-type: none"> • Shock spa with sanitizer • Add sanitizer • Adjust pH to recommended range
Chlorine Odor	<ul style="list-style-type: none"> • Chloramine level too high • Low pH 	<ul style="list-style-type: none"> • Shock spa with sanitizer • Adjust pH to recommended range
Musty Odor	<ul style="list-style-type: none"> • Bacteria or algae growth 	<ul style="list-style-type: none"> • Shock spa with sanitizer – if problem is visible or persistent, drain, clean and refill the spa
Organic buildup / scum ring around spa	<ul style="list-style-type: none"> • Buildup of oils and dirt 	<ul style="list-style-type: none"> • Wipe off scum with clean rag – if severe, drain the spa, use a spa surface and tile cleaner to remove the scum and refill the spa
Algae Growth	<ul style="list-style-type: none"> • High pH • Low sanitizer level 	<ul style="list-style-type: none"> • Shock spa with sanitizer and adjust pH • Shock spa with sanitizer and maintain sanitizer level
Eye Irritation	<ul style="list-style-type: none"> • Low pH • Low sanitizer level 	<ul style="list-style-type: none"> • Adjust pH • Shock spa with sanitizer and maintain sanitizer level
Skin Irritation / Rash	<ul style="list-style-type: none"> • Unsanitary water • Free chlorine level above 5 ppm 	<ul style="list-style-type: none"> • Shock spa with sanitizer and maintain sanitizer level • Allow free chlorine level to drop below 5 ppm before spa use
Stains	<ul style="list-style-type: none"> • Total alkalinity and/or pH too low • High iron or copper in source water 	<ul style="list-style-type: none"> • Adjust total alkalinity and/or pH • Use a stain and scale inhibitor
Scale	<ul style="list-style-type: none"> • High calcium content in water – total alkalinity and pH too high 	<ul style="list-style-type: none"> • Adjust total alkalinity and pH – if scale requires removal, drain the spa, scrub off the scale, refill the spa and balance the water • Use a stain and scale inhibitor

Cleaning and Maintenance

Removing and Reseating the Pillows

You can remove the pillows for cleaning and maintenance quickly and easily. This method works for all types of pillows.

Grab the lower edge of the pillow with both hands firmly and pull up. As you do this, the pillow inserts will pop out of the holes.

Reseat the pillows by aligning the pillow inserts with the holes and striking the pillow hard enough to insert the pegs back into the holes.

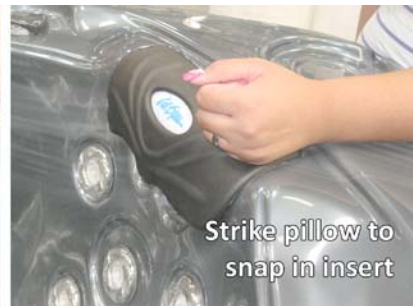

Jet Removal and Replacement

Jets can be easily removed for cleaning.

Grasp the outer rim of the jet and turn it counter-clockwise. The jet will unscrew from the fitting until it is free.

To replace the jet, place it in the fitting and turn it clockwise until it is snug in place. Do not overtighten the jet.

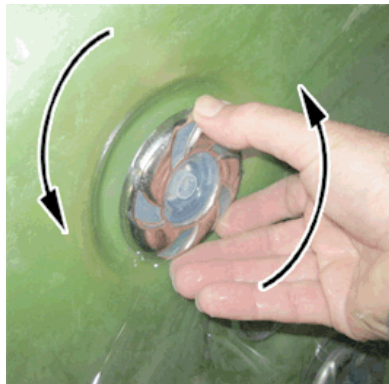

Spa Cover

Important! Keep the spa covered when not in use!

- Covered spas will use less electricity in maintaining your set temperature.
- Covering your spa will protect your spa's finish from the sun's ultraviolet rays.
- You are required to keep the spa covered to maintain warranty coverage.
- Covering your spa helps prevent children from drowning in the spa.

See the manual enclosed with your cover for instructions on mounting the locks and how to lock and unlock the cover.

In addition, while the spa cover is rigid, it is not designed to support any weight. Therefore, as a safety precaution and to preserve the life of your cover, you must not sit, stand, or lie on it, nor should you place objects of any kind on top of it.

Draining Your Portable Spa

Your spa should be drained every four to six months, and refilled with fresh tap water. The following is the recommended method for draining your spa.

For spas with cabinet mounted drain:

1. Turn off the power at the breaker.
2. Remove all filters.
3. Pull the knob out about 5cm until it snaps into place.

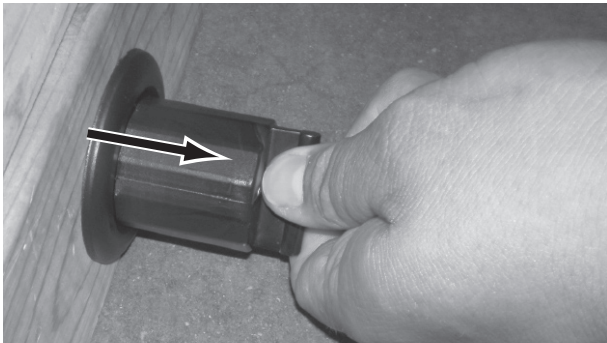

4. Unscrew the cap.

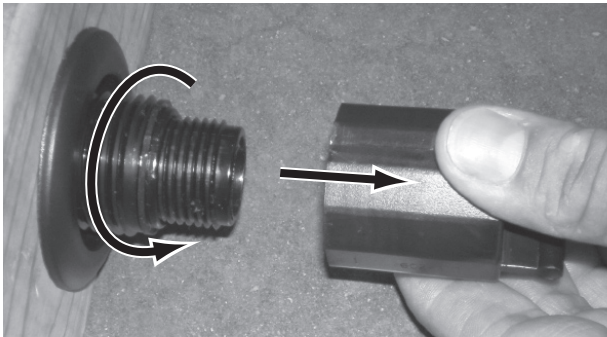

5. Hook up the female end of a garden hose to the drain fitting.

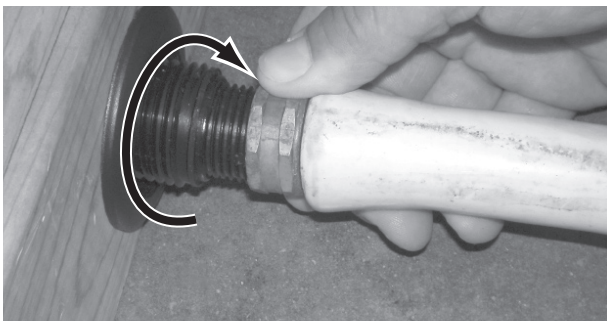

6. Place the other end of the garden hose where you would like the water to drain to.
7. Pull the hose outward about 1.5cm to start water flow. Push inward to shut off water flow.

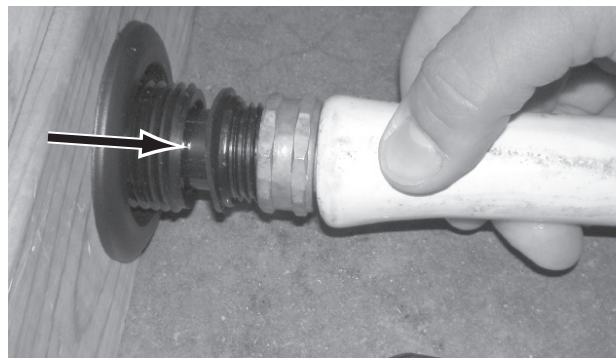

8. Let spa drain completely.
9. Push the hose inward about 1.5cm, then remove the garden hose.
10. Replace the cap.
11. Push the knob in about 5cm until it snaps back into place.

For spas with drain inside the spa:

1. Turn off the power at the breaker.
2. Remove all filters.
3. Using a Phillips screwdriver, remove the screws to the access panel and open it.
4. Locate hose ending with the $\frac{3}{4}$ " hose-bib fixture.
5. Unscrew the cap.
6. Hook up the female end of a garden hose to the drain fitting.
7. Place the other end of the garden hose where you would like the water to drain to.
8. Turn the valve on the hose-bib fixture to open the drain.
9. Let spa drain completely, then remove garden hose.
10. Turn the valve on the hose-bib fixture to close the drain.
11. Replace the cap.

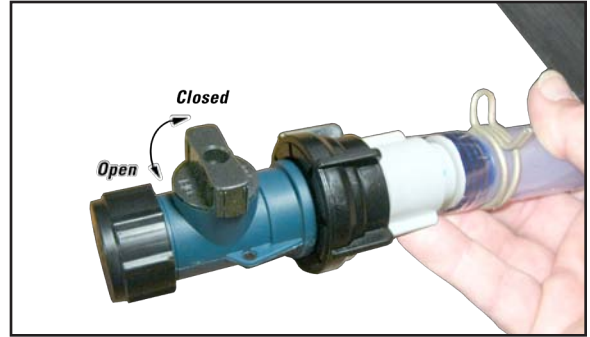

Winterizing (Cold Climate Draining)

In many areas of the country, the temperature drops below 0°C (32°F). We recommend that you always have your spa full of water and running at normal spa temperatures (26.7°C to 37.8°C or 80°F to 100°F). This will help reduce the risk of freezing in your spa and your spa's equipment.

Warning: If you find the need to drain your spa, be aware of the potential of freezing in your spas equipment and plumbing. Even if the directions below are followed perfectly, there is no guarantee that your spa will not suffer freeze damage.

Freeze damage is not covered by your warranty.

1. Open all filter covers.
2. Remove the filter baskets and filters.
3. Drain your spa completely as described in the instructions above.
4. Vacuum water from the spa's main drain fitting with a wet/dry vacuum.
5. Remove drain plugs from the front of the pumps.
6. Disconnect the unions from both sides of the pump.
7. Blow any remaining water out of the jets and equipment area with the wet/dry vacuum.
8. Cover your spa with a good spa cover and an all-weather tarp to ensure that neither rain nor snow enters the spa.



NOTE: All manifolds are plumbed in series directly to the main drain (see example at right), making it easier to remove water and reducing the possibility of freeze damage.

Cleaning and Replacing the Filter

Filtration is one of the most important steps you can take to ensure clean, clear water. It is far less expensive to fix water clarity problems by filtering your spa than by using excessive amounts of chemicals, excessive filtration times, or by water replacement.

See the section “Filter Cleaning” on page 38 for more information.

Vacation Care

You can leave your spa unattended for up to two weeks if you follow these instructions.

ALWAYS lock your cover using the cover locks if you plan to be away from home and the spa is filled with water.

1. Select the Low Range temp choice used for vacation mode. (See instructions on page 17 or page 27 for vacation setting.)
2. Following the water quality instructions starting on page 36, adjust the pH.
3. Shock the water (add either chlorine or bromine sanitizer).
4. When you return, check and adjust the pH and shock the water.

If you will not be using your spa for longer than 14 days and a spa maintenance service is not available, we strongly recommend you drain or winterize your spa.

Cleaning Your Spa

Spa Cover and Pillows

Due to the constant punishment your spa cover and pillows receive, you should protect them by applying a vinyl and leather cleaner as part of your monthly maintenance plan. Use a product that is specifically designed to protect spa covers and pillows from chemical and ultraviolet light damage without leaving an oily residue behind that is normally associated with common automotive vinyl protectants.

Warning: *Do not* use automotive vinyl protectants on spa covers or pillows. These products are generally oil-based and will cause severe water clarity issues that are difficult to correct.

Spa Shell

Each time you drain your spa, before you refill it you should clean your spa shell with an all-purpose cleaner and apply a coat of surface protectant.

Use a low detergent, non-abrasive cleaner specifically formulated to clean the spa without damaging its acrylic finish.

Use a non-oil based surface protectant that is specifically formulated to protect the spa’s finish from the chemicals and minerals associated with normal spa use.

Changing the UV Lamp

CAUTION: Always turn off power to the spa at the RCD prior to any maintenance.

Note: Periodically you should check the light on the transformer for the UV light system. The transformer is mounted in the spa equipment area in a water resistant enclosure with a door. When it is operating normally, the light will be green. When it requires maintenance, it will be red. This usually happens when the UV lamp needs replacing. The UV lamp is a wearable part that needs replacing about once a year.

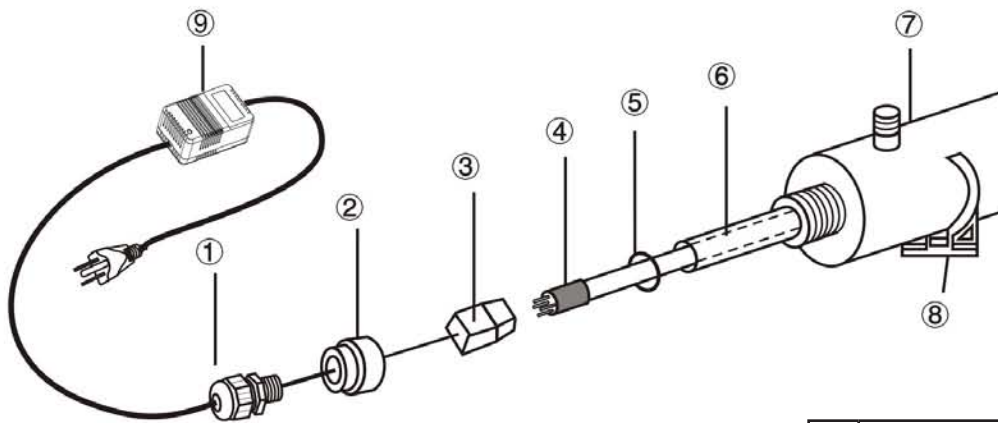

To remove the UV lamp

1. Disconnect power.
2. Turn water off and open down stream of system to relieve pressure.
3. Remove the water-proof strainer (1) and unscrew the aluminum nut (2).
4. Pull out the lamp (4) approximately 2" from the chamber (7).
5. While holding the lamp end, remove the lamp socket (3) from the end now exposed.
6. Remove the lamp from the chamber.
7. Remove the O-ring (5) from the end of the quartz thimble (6).
8. Remove the quartz thimble.

1	Water-proof strainer
2	Aluminum nut
3	Lamp socket and lead wire
4	Germicidal UV lamp
5	Rubber O-ring
6	Quartz thimble
7	Chamber
8	Clip
9	Ballast

See page 64 for part numbers for replacement parts.

To reinstall the replacement UV lamp, follow these steps in reverse.

When replacement UV lamp has been installed, conduct a final leak check:

1. Restore power to the spa at the RCD.
2. Turn on the pump and let water run for five minutes to check for leaks.

Using the Entertainment System

Some spas may be equipped with an optional entertainment system. Each spa equipped with an audio/visual system is delivered with the manufacturer's operating instructions in a clear plastic bag.

The instructions contained in this manual describe only basic functions. See the manufacturer's operating instructions for other features and functions. We strongly recommend that you read the manufacturer's instructions prior to operating this unit.

Observe the following precautions for your entertainment system:

- Make sure that hands are dry before coming in contact with this or any electronic option.
- Always close the protective door.

Although the marine grade entertainment system is encased in a plastic housing with weather seals, the system is **water resistant** and **NOT waterproof**. You must take every precaution to keep this system dry!

Water damage is not covered by Cal Spas or the manufacturer's warranty.

Aquatic AV AQ-DM-3B Media Locker

The Aquatic AV docking station has very basic features. It will play any audio device with a 3.5mm headphone plug. This device does not use a remote and does not offer Bluetooth connectivity.

The device requires a short connector (NOT PROVIDED) with two 3.5mm connector jacks that attach from your audio device to the inside of the locker.

To open the locker, slide the latch up to unlock the door.

Press the power button inside the locker. The red LED will turn on.

Plug a 3.5mm connector into your audio device and to the inside of the locker.

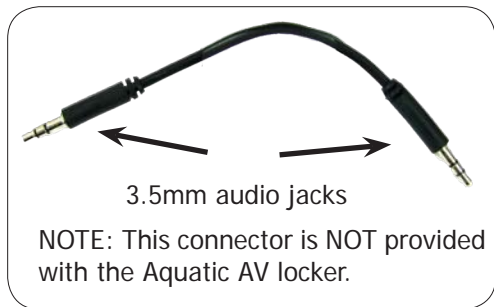

Use the Velcro strap to keep your device secure inside the locker while it is in use.

While your audio device is in the locker, close the door and slide the lock to keep it secure and water tight. If this is done properly, it will protect your audio device.

The front panel has basic controls for controlling the audio only. All other functions, such as track selection, must be controlled from your audio device.



Aquavibe MD-350 Docking Station

The Aquavibe docking station can be used with an iPhone, iPad, any device with a 3.5mm audio output (headphone jack), or any Bluetooth capable device. These instructions contain brief descriptions of commonly used features and functions. For more in-depth information on the Aquavibe MD-350, see the user's manual that was included in the docking station.

Pairing the Remote Control

1. Press and hold the MODE button on the remote control until "PAIR" appears in its display.
2. While still holding the MODE button on the remote control, press the RESET button in the interior of the waterproof compartment.
3. If the pairing is successful, the dock will restart and "PAIR" will disappear from the remote's display. Release the MODE button on the remote control.

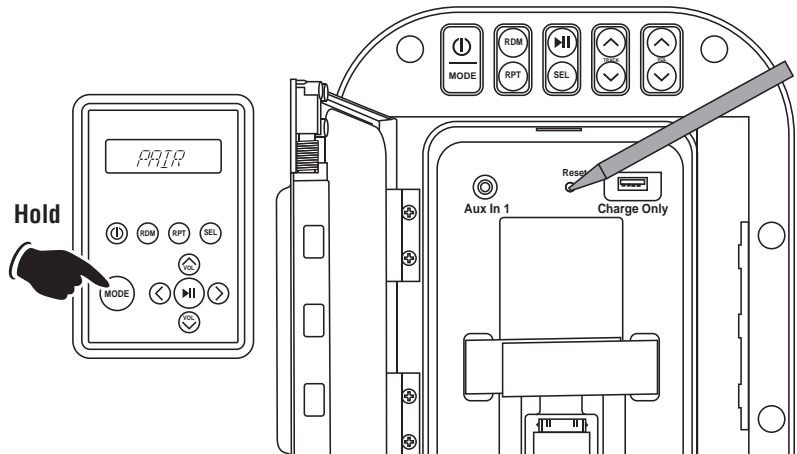

IPHONE or IPOD

1. Open the waterproof door and pull out the 30-pin connector.
2. Plug the connector into the Apple device.
3. Secure the Apple device with the mounting straps.
4. Close the waterproof door.
5. Press the MODE button until "IPOD" appears in the display.
6. Use the controls on the locker door to operate the iPod functions.

The unit will automatically switch to the "IPOD" mode when the IPHONE or IPOD is initially connected to the 30-pin connector.

If your Apple device uses a lightning connector, a lightning adapter will plug into the 30-pin connector and will allow you to operate the device normally.

If you use the USB cable that came with your Apple device and plug it into the Charge Only socket, it will only charge the Apple device. It will not control the device.

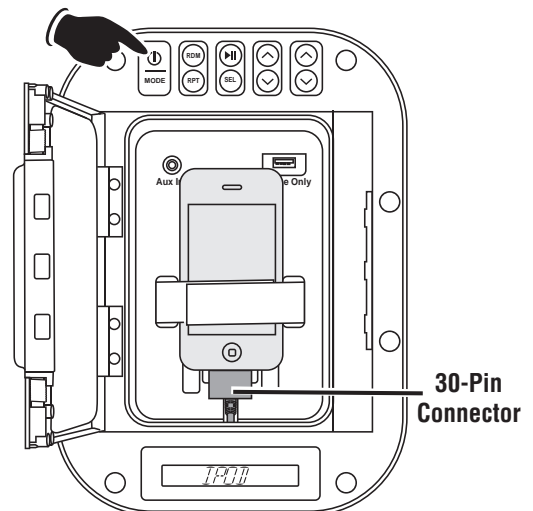

You can also use the Aquavibe remote to operate the Apple device. See remote operation on the next page.

Using a Device with 3.5mm Audio Output

1. Open the waterproof door and plug a 3.5mm cable (not supplied) into the docking station and then into the device.
2. Plug a USB cable (not supplied) into the docking station and then into the device.
3. Secure the device with the mounting straps.
4. Close the waterproof door.
5. Press the MODE button until "AUX IN1" appears in the display.
6. Use the controls on the entertainment center to adjust the volume.

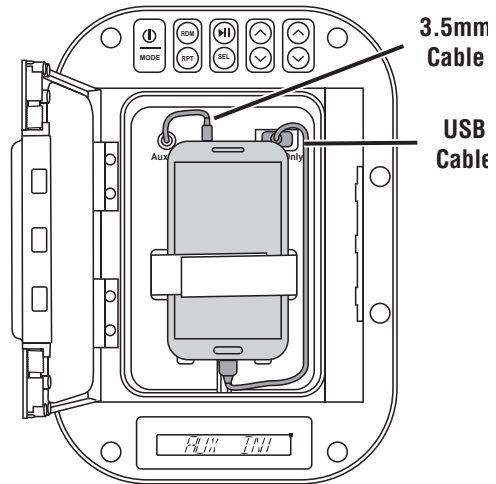

The USB cable does not have to be connected for proper operation. Connecting the USB cable will only charge the device. No data transfer will occur. If cables are not being used, remove the cable from the waterproof compartment. The unit will not automatically switch to "AUX IN1" mode when the device is initially connected to the 3.5mm cable. Select "AUX IN1" using the MODE button. The entertainment center will not control the device. It just allows for the audio from the device to play through the entertainment center.

NOTE: These connectors are NOT provided with the Aquavibe locker.

3.5mm audio jacks

USB cable for your phone or audio player

Pairing Bluetooth Devices

1. Open the Bluetooth setup program on the mobile device and activate the Bluetooth feature.
2. Press the button to turn on the entertainment center.
3. From your mobile device scan for available devices. Select "AQUAVIBE" to connect to the unit.
4. When the mobile device has been paired will appear in the entertainment center's display.
5. Press the MODE button until "BT AUDIO" appears in the display. Bluetooth audio from your mobile device can now be played through the entertainment center.

Note 1: A previously paired Bluetooth mobile device will automatically connect to the entertainment center when "BT AUDIO" is selected using the MODE button (if it is within range).

Note 2: If the Bluetooth mobile device is already paired with the entertainment center, select "AQUAVIBE" on your phone and touch "Connect".

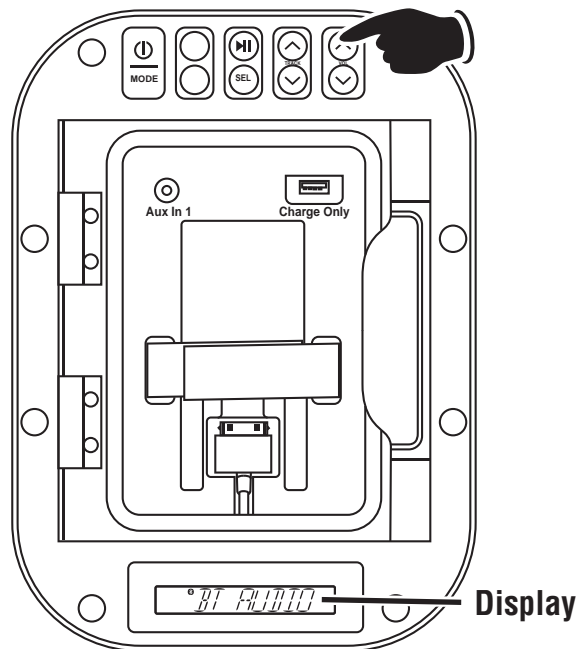

Keeping Fit With Your Swim Spa

Jetstream Propulsion System

Use the control panel to start and stop the Jetstream Propulsion System. The **Jets** and **Aux** buttons control the top and bottom jets.



Use the air venturi valves to inject air in the water streams.

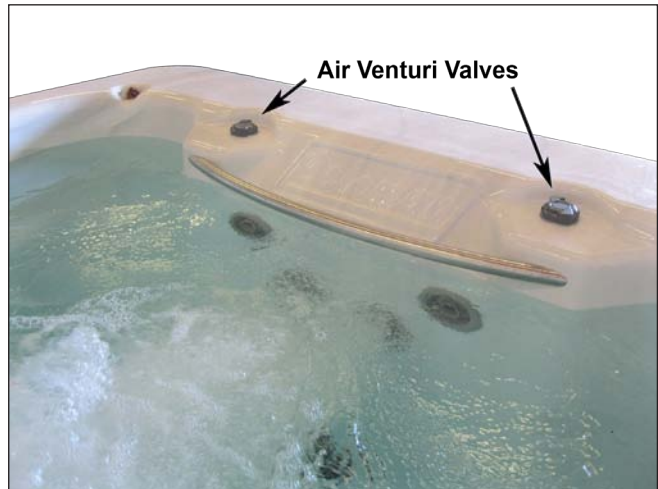

Assembling the Swim Tether

The swim tether pole has three pieces and assembles easily. Slide the ends of the top and middle sections into the middle and bottom sections as shown at right.

Insert the tether in the anchor hole when you are ready to use it.

Buckle the strap around your waist. It is easily adjustable and can accommodate most sizes.



Using the Exercise Equipment

IMPORTANT: Always consult your physician before starting any exercise activity or program. The Ultimate Fitness series spas feature rubber exercise bands. When stretched, these bands create a high tension condition. Improper use or failure to connect the exercise bands properly may cause injury. Always inspect all of the exercise equipment prior to beginning any exercise. Do not use any damaged equipment.

This equipment attaches to the exercise anchors located on the spa walls.

Connecting the Exercise Equipment

The drawings below show different ways the exercise kit can be connected depending on the exercises you wish to do.

For 12 and 14 foot spas:

The exercise kit for 12 and 14 foot spas contains:

- Two hand grips
- Two ankle braces
- Two 6" elastic bands
- Two 18" elastic bands
- Two 25" elastic bands
- Two rowing bars

For 16 and 17 foot spas:

The exercise kit for 16 and 17 foot spas contains:

- Two hand grips
- Two ankle braces
- Two 18" elastic bands
- Two 25" elastic bands
- Two 56" elastic bands
- Two rowing bars

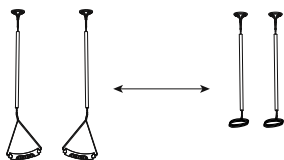
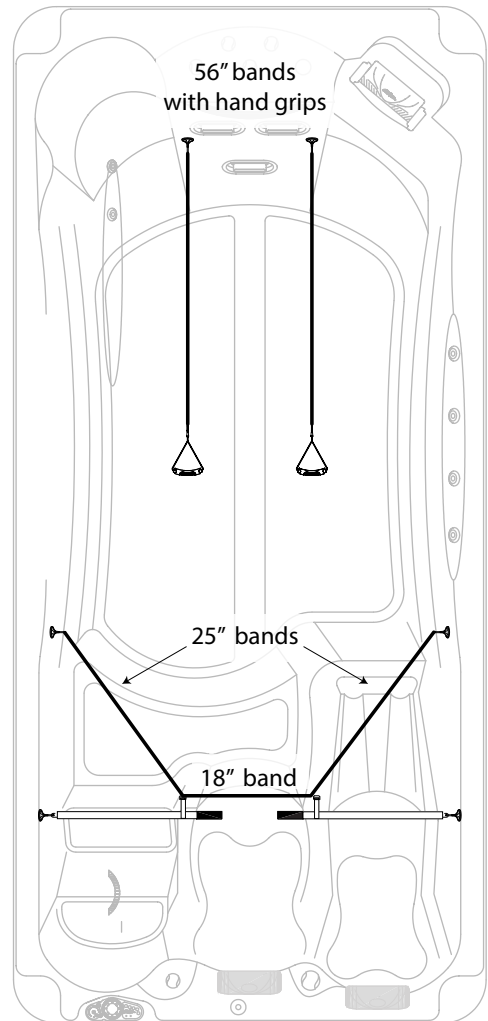
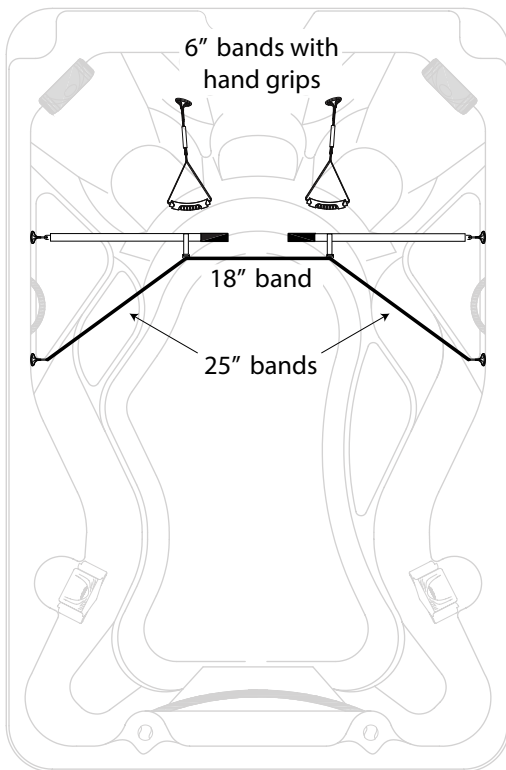
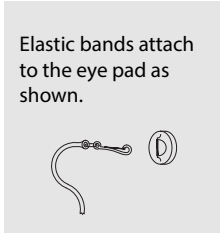

All elastic bands can be connected to the end of the spa and used with either hand grips or ankle braces.

All elastic bands can also be used with either hand grips or ankle braces.



Appendix

Replacement Parts





Please visit www.quickspaparts.com to order your replacement parts.

Note: All Cal Spa models use screw-in jet inserts where removable jets are used. (The River Jet and Old Faithful jets do not have removable jet inserts.)

Jets	
ELE 2" Euro No Eyeball PLUCS2295021SL 	2" 3"
ED 2" Euro Directional PLUCS2295051SL 	2" 3"
NJD 2" Directional Neck Jet 100% Shut Off PLUCS2255041SL 	2" 3"
MED 3" XL Cluster Storm Directional PLUCS2295031SL 	3" 3 1/2"
mfd 3" Micro Jet Directional PLUCS2295061SL 	3" 3 3/4"

Jets	
MM 3" Mini Storm Massage PLUCS2297061SL-8 	3" 4"
MFD 3.5" Maxi Jet Directionsl PLUCS2295091SL 	3 1/2" 4 1/4"
PSD 5" Power Storm PLUCS2295131SL 	5" 5 1/2"
PSR 5" Power Storm Riffed PLUCS2295141SL 	5" 5 1/2"

Jets	
PST 5" Power Storm Wagon Wheel PLUCS2295191SL 	
T 5" Tornado Adjustable PLUCS2295201SL 	
River Jet Assembly Black 210-5101CS PLU210-5101SCS 	
Old Faithful Jet Black PLU21703739 	

Pillows	
Cascade Pillow No Insert Black ACC01401031 	
Infinity Pillow Ribbed Black ACC01401051 	
Infinity Pillow Plain Black ACC01401061 	
Water Diverter Valves	
Diverter Valve 2" with Swoosh Logo Black (CS6003038-1) PLU21300461 	
Diverter Valve 1" with Swoosh logo Black (CS6004231) PLU21300451 	
Diverter Valve 1 1/2" On/Off ASSY (600-4601) PLU21100045 	

Air Control Valve

**Air Control with Swoosh
Logo Black CS6603508-1**

PLU21300501



Waterfalls

**Waterfall 12-3/8"
W/ Logo, LED
(Round) Textured
(CS675952T8L-1) '14**

PLU21800828



**Waterfall 12-
3/8" No Logo, LED
(Round) Textured
(CS675953T8L-1) '14**

PLU21800829



Hydro Stream Waterfall

PLU21800623



Drains

**Drain Super Hi Flo Suction
2 1/2" Black (640-3581LGV)**

PLU21400146



**Low Profile Drain 3/4" Black
(640-0511)**

PLU21400401



**Bottom Drain Filtration
Return Assembly**

PLU21400215

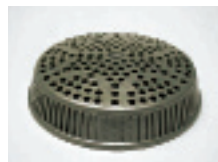

Weir Skimmers

**Weir Skimmer Gate
Small Black**

PLU21600284



Please visit www.quickspaparts.com
to order your replacement parts.

Weir Skimmers

**Weir Skimmer Gate
Large Black**

PLU21600294



Filters

All filters are anti-bacterial threaded cartridges.

25 Sq Ft

FIL11100303



50 Sq Ft

FIL11100202



75 Sq Ft

FIL11100212



Pure Cure™ UV Water Sanitizer

**Pure Cure complete
system**

LIT16000380



**Germicidal UV lamp
(T515)**

LIT16000381



**Rubber O-ring
(D24.5)**

LIT16000384



**Quartz thimble
(24.5X350)**

LIT16000383



Ballast (UV-3)

LIT16000382





Please visit www.quickspaparts.com to order your replacement parts.

Pure Cure™ UV Water Sanitizer	
Clips LIT16000385	

Lights	
Light Assembly Complete LIT16000150	
Light Mini 2" Diameter LIT16000151	

LED Lights	
Small Controller Daisy Chain LIT16100218	
Large Controller LIT16100241	
Quad LED Daisy Chain Assembly LIT16100211	
Dual LED Daisy Chain Assembly LIT16100212	
7 LED 2" Light Daisy Chain with Stand-Off LIT16100214	

LED Lights	
LED Light, 12 LED LIT16100206	

Exercise Equipment	
Exercise Kit for 16 Foot and 17 Foot Spas EXC12000007	
Exercise Kit Attachment Plate EXC11000065	

Replacement Cabinet Panels	
The complete selection of replacement cabinets for all models is very extensive and too lengthy for this owner's manual. To order replacement panels for your spa, visit www.quickspaparts.com .	

Please visit www.quickspaparts.com to order your replacement parts.

Covers

All spa covers are designed with a tapered height, angling downward from the center to the sides to drive off rain and prevent water from pooling.

Covers - all sizes except 7 foot and 8 foot spas

The covers listed below are filled with either 1 lb. or 1.5 lb. foam.

Basic

4" - 2.5"

1.0 Lb. foam

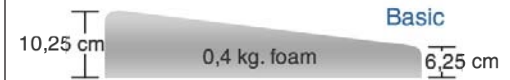

Standard

4" - 2.5"

1.5 Lb. foam



Size	Fits spa models	Type	Part numbers
54" x 78"	Z-524L	Basic	Gray COV5478BAS42G1.0 Slate COV5478BAS42S1.0 Black COV5478BAS42B1.0
64" x 84"	Z-536L Z-536L-VP	Basic	Gray COV6484BAS42G1.0 Slate COV6484BAS42S1.0 Black COV6484BAS42B1.0
72" x 72" triangle	Z-628T	Basic	Gray COV7272TRBAS42G1.0 Slate COV7272TRBAS42S1.0 Black COV7272TRBAS42B1.0
		Standard	Gray COV7272TRSTD53G1.5 Slate COV7272TRSTD53S1.5 Black COV7272TRSTD53B1.5
76" x 84"	Z-630B	Basic	Gray COV7684BAS42G1.0 Slate COV7684BAS42S1.0 Black COV7684BAS42B1.0
78" x 84"	Z-630L, Z630B Z-630L-VP, Z630B-VP	Basic	Gray COV7884BAS42G1.0 Slate COV7884BAS42S1.0 Black COV7884BAS42B1.0
78" round	Z-515R	Basic	Gray COV78RDBAS42G1.0 Slate COV78RDBAS42S1.0 Black COV78RDBAS42B1.0
93" x 130"	P-970N	Standard	Gray COV93130STD53G1.5 Slate COV93130STD53S1.5 Black COV93130STD53B1.5

Please visit www.quickspaparts.com to order your replacement parts.

Size	Fits spa models	Type	Part numbers	
93" x 132"	E-947E	Standard	Gray	COV93132STD53G1.5
			Slate	COV93132STD53S1.5
			Black	COV93132STD53B1.5
93" x 171"	FS-1420, FS-1439	Standard	Gray	COV93171STD53G1.5
			Slate	COV93171STD53S1.5
			Black	COV93171STD53B1.5
93" x 200'	FS-1640, FS-1770	Standard	Gray	COV93200STD53G1.5
			Slate	COV93200STD53S1.5
			Black	COV93200STD53B1.5

Please visit www.quickspaparts.com to order your replacement parts.

Covers - 7 foot and 8 foot spas

Seven foot and eight foot spa covers listed below are available with the following tapers and foam densities:

Basic

10,25 cm - 6,25 cm (4" - 2.5")
0,4 kg foam (1.0 lb)



Standard

12,75 cm - 7,6 cm (5" - 3")
0,7 kg foam (1.5 lb)



Deluxe

12,75 cm - 7,6 cm (5" - 3")
0,9 kg foam (2.0 lb)



Size	Fits spa models	Taper and type	Part numbers
84" x 84" (7 foot spas)	Z-731L, Z-731B Z-731L-VP, Z-731B-VP C-750L, C-750B C-750L-Lxi, C-750B-Lxi E-758L, E-725B V-700L P-760L, P-760B	Basic	Gray Rust Slate Black
		Standard	Gray Rust Slate Black
		Deluxe	Gray Rust Slate Black
93" X 93" (8 foot spas)	C-850L, C-850B, C-850L-Lxi, C-850B-Lxi E-862, E-864L, E-864B V-800L P-860L, P-860B, P-880L, P-880B	Basic	Gray Rust Slate Black
		Standard	Gray Rust Slate Black
		Deluxe	Gray Rust Slate Black

Troubleshooting

Symptom	Possible Causes	Possible Solutions
System / Power Problems		
System does not work	Power is turned off	Reset spa
Control pad and spa equipment do not operate	No electrical power to spa	Turn on or reset the RCD breaker. If this does not solve the problem, have a qualified electrician check the electrical service.
	The 20 or 30A fuse, depending on the system, has blown	Contact your dealer
The spa does not turn off	Spa is trying to heat up	Check the temperature setting is in Standard mode
	Spa is in filter cycle	Normal. No adjustment necessary
	Spa is in Standard mode	Check setting
Control panel displays a message	An error may have occurred	See Diagnostic Messages on page 22 or page 29 for message code meanings
RCD breaker trips repeatedly	Improper wiring to spa or RCD breaker is defective	Consult with a qualified electrician
	There is a defective component on the spa	Contact your dealer
Heat Problems		
Spa does not heat	Heating mode not selected	See control panel instructions on pages through
	Water level is too low	Add water to correct level
	No electrical power to spa	Turn on or reset the RCD circuit breaker. If this does not solve the problem, have a qualified electrician check the electrical service.
	Heater is defective	Contact your dealer
	Gate valve is partially or fully closed	Open gate valves. Note: Never operate your spa with the gate valves closed!
Spa gets warm but does not get hot	Thermostat has been turned down	Set control panel to a higher temperature
	Insufficient filtration time	Increase filtration time
	Water level is too low	Add water to correct level
	No electrical power to spa	Turn on or reset the RCD circuit breaker. If this does not solve the problem, have a qualified electrician check the electrical service.
	Dirty filter cartridge	Clean filter cartridge
	Gate valves closed	Open gate valves
	Spa cover improperly positioned	Align spa cover
Spa gets too hot	Filtration time is set too long	Reduce filtration cycles, especially during summer months

Symptom	Possible Causes	Possible Solutions
Water Problems		
Water is not clean	For all water clarity problems, see page 35.	
High water consumption	Very high evaporation or heavy splashing	Use the cover and refill as necessary
Low water stream from the jets	Running in FILTER mode - slow speed	Select high speed jets
	Block wall suction or skimmer	Clean the wall suction/skimmer. Remove blockage
	Dirty filter	Clean filter and replace
	Jets are closed	Open jets
	Valves closed	Open valves
No water stream from the jets	Pump has airlock	Remove airlock by priming spa (page 14)
	Jets are closed	Open jets
	Power switched off, system off	Reset power
	Pump is defective	Contact your dealer
	Pump fluctuations	Low water. Check level on skimmer flap
Water leakage from below the spa	Check the connections and empty the hoses	Close or turn off empty cycle if necessary
Water Pressure Problems		
Jets surge on and off	Water level is too low	Add water to normal level
Jets are weaker than normal or do not work at all	Jet valves are partially or fully closed	Open jet valves
	Filter cartridge is dirty	See Cleaning the Filter
	Air is trapped in the pump	Open the air bleed valve on each pump's housing and allow air to bleed out of the system. Be sure to tighten each air bleed valve as soon as water starts to flow.
	The suction fittings are blocked	Remove any debris that may be blocking the suction fittings
	Gate valve is closed	Open gate valves. Note: Never operate your spa with the gate valves closed!
Air and Jets Problems		
No airstream from the jets	Air control not open	Open the control
	Jet spout opening not fixed properly	Check jet spout openings
	Jet spout opening missing	Check jets and replace as necessary
Light Problems		
Standard spa light does not work	Light bulb has burned out	Replace light bulb
	Lighting system is defective	Contact your dealer
Pump Problems		

Symptom	Possible Causes	Possible Solutions
Pump runs constantly – will not shut off	Problem with circuit board	Contact your dealer
Noisy pump	Water level is too low	Add water to normal level
	Block wall suction or skimmer	Clean the wall suction/skimmer
	Damaged or worn-out motor block	Contact your dealer
	Clogged floor suction or skimmer	Clean floor suction or skimmer
	Leakage of air into suction line	Contact your dealer
	Debris is inside pump	Contact your dealer
	Gate valves are closed	Open gate valves. Note: Never operate your spa with the gate valves closed!
	Damaged or worn motor bearings	Contact your dealer
	Improper or defective wiring	Contact your dealer
Pump turns off during operation	Automatic timer has completed its cycle	Start the cycle again
	Pump has overheated due to the vents on the equipment door being blocked	Clear items away from vents
	The pump motor is defective	Contact your dealer
Pump has a burning smell while running	Damaged or worn motor bearings	Contact your dealer
Pump does not work	Power may be turned off	Reset power
	Pump has over heated	Let cool for one hour
	Incorrect or faulty wiring of electrical supply	Contact your dealer
	Switch is off	Auto reset after the motor has cooled down
	House circuit breaker tripped or in OFF position	Reset circuit breaker Contact your dealer
	Motor overload condition	Motor overload will reset automatically. If problem persists, contact your dealer
	Damaged electrical cord	Contact your dealer
	Pump cord not plugged in	Plug pump cord into red receptacle
	RCD tripped or in OFF position	Reset RCD

LIMITED WARRANTY

This Limited Warranty is extended to the original purchaser of a Cal Spa brand portable spa manufactured after January 1, 2014 and installed for residential use outside the United States of America and Canada. This warranty begins on the date of delivery of the spa, but in no event later than one year from the date of manufacture.

	This warranty applies only to these spa lines:		
	Patio	Connect	Escape, Platinum, Fitness
Shell Structural Warranted against water loss due to defects in the spa shell.	5 years	5 years	7 years
Shell Finish Warranted against blistering, cracking, or delaminating of the interior surface of the spa shell.	3 years	5 years	5 years
Pure Heat™ Heater Warranted to be free from defects in materials and workmanship. (Optional feature for Connect)	N/A	5 years	5 years
Equipment and Controls Electrical equipment components – specifically limited to the pumps and control system – are warranted against malfunctions due to defects in workmanship or materials.	3 years	3 years	5 years
Plumbing Warranted against leaks due to defects in workmanship or materials.	3 years	3 years	5 years
Cabinet - synthetic, fiberglass, or wicker Warranted against defects in workmanship or materials. Normal wear and weathering of the finish will occur naturally over time and are not defects.	1 year	1 year	3 years
Hercules™ Cabinets and panels Lifetime guarantee against defects in workmanship or materials. Normal wear and weathering of the finish will occur naturally over time and are not defects. Applies to Patio series only.	Lifetime guarantee	N/A	N/A

Warranties for Other Components

The fuses, headrests, cabinet finish, and filters are warranted to be free of defects in workmanship and material at the time of delivery. The factory installed Pure Cure water purification system is warranted against malfunction due to defects in workmanship or material for one year from the original date of delivery except the UV bulb and quartz tube. The UV bulb and quartz tube are warranted for ninety (90) days from the original date of the spa delivery. All stereo-related components (receiver, speakers, sub-woofer, stereo media locker, power supply, wireless remote control etc.) are warranted against malfunction due to defects in workmanship or material for one year from the original date of delivery. All other factory-installed components not mentioned specifically, including, but

not limited to the wood frame, jets, diverter valves, LED lighting systems, filter lids, and mechanical components, are warranted against malfunction due to defects in workmanship and material for two years from the original date of delivery.

Genuine Cal Spas Parts & Accessories

This Limited Warranty is void if Cal Spas (the "Manufacturer") or its designated representative determines that the spa has been subjected to damage or failure due to installation of aftermarket parts that are not genuine Cal Spas branded parts and accessories. This disclaimer includes, but is not limited to filters, UV bulbs, ozone systems, salt systems, repair parts and other accessories. Genuine Cal Spas brand parts and accessories are built to our highest

standards of quality, durability and performance, and they are designed to work with your Spa to ensure optimal performance and function.

Performance

This warranty begins on the date of delivery of the spa, but in no event later than one year from the date of manufacture. To obtain service in the event of a defect covered by this Limited Warranty, notify your Cal Spa dealer or Cal Spas (the "Manufacturer") as soon as possible and use all reasonable means to protect the spa from further damage. Upon proof of purchase, a designated service representative will correct the defect subject to the terms and conditions contained in this Limited Warranty. There will be no charge for parts or labor to repair the defect, although providing access to affect the repair is your responsibility as the spa owner. Freight charges for replacement parts is the responsibility of the spa owner. You may be assessed reasonable repairman travel mileage charges. In the event that the spa is removed to a repair facility for repair and reinstalled, the cost of removal and reinstallation will be your responsibility as the spa owner. If the Manufacturer determines that repair of the covered defect is not feasible, it reserves the right to provide a replacement spa instead, equal in value to the purchase price of the original spa. In such an event, reasonable costs for removal of the original spa, shipping costs from the factory for the replacement spa and delivery and installation of the replacement will be your responsibility as the spa owner. The replacement spa will carry the balance of the original spa's warranty. Spa covers are not included. This warranty ends either by specified time frame, owner-transfer, relocation, or installation of any component other than by manufacturer.

Warranty Limitations

This Limited Warranty is void if: Cal Spas (the "Manufacturer") or its designated representative determines that the spa has been subjected to alteration, neglect, misuse or abuse, or freight damage caused by the common carrier; any repairs have been attempted by anyone other than a designated representative; or if the failure is caused by accident, acts of God or other causes beyond the control of the Manufacturer. Neglect, misuse and abuse include any installation, operation or maintenance of the spa other than in accordance with the instructions contained in the owner's manual provided with the spa, including but not limited to the failure to maintain proper water chemistry and chemical balance and the use of abrasive or improper cleaners or non-genuine parts and accessories. This Limited Warranty does not

provide coverage for the insulating cover, any item attached to or installed on the spa after the date of manufacture, or for gaining access to any component for repair or replacement. Spa units in commercial use are excluded from any coverage whatsoever. The spa owner accepts liability for repair work performed by anyone other than the Manufacturer or a designated Cal Spa representative.

Limitations

The Manufacturer disclaims all warranties, expressed or implied, in fact or in law, to the extent allowed by your State's Law, including the warranty of merchantability and fitness for use, except as stated specifically herein. All warranty service must be performed by the Manufacturer or its designated representative using authorized Cal Spa parts. No agent, dealer, distributor, service company or other party is authorized to change, modify or extend the terms of this limited warranty in any manner whatsoever. The Manufacturer will not be responsible for any statements or representations made in any form that go beyond, are broader than, or are inconsistent with any authorized literature or specifications furnished by Cal Spas.

Disclaimers

The Manufacturer and its representatives shall not be liable for any injury, loss, cost or other damage, whether incidental or consequential, arising out of any defect covered by this limited warranty, including without limitation, loss of use of the spa and cost for removal of defective product even if the Manufacturer was advised of the possibility of damage. The liability of the Manufacturer under this limited warranty, if any, shall not exceed the original amount paid for the defective product. Coverage under this limited warranty shall commence as of the original date of delivery and the duration of such coverage shall not extend for any reason whatsoever beyond the stated time periods. These disclaimers shall be equally applicable to any service provided by the Manufacturer and its designated representatives.

Legal Rights

This Limited Warranty gives you specific legal rights. You may also have other rights that vary from state to state. Some states do not allow limitations on how long an implied warranty lasts, so this limitation may not apply to you.



Locating the product serial number

The serial number of your Cal Spa is located on a metal plate attached to the lower right front panel of the spa. You will need this number to properly register your spa and activate coverage. Write this information in the space provided below.

Cal Spa Model: _____

Cal Spa Serial Number: _____

Date Purchased: _____

Date Installed: _____

Cal Spa Dealer's Phone Number: _____

Cal Spa Dealer's Address: _____

CONTACT INFORMATION

For customer service, please contact your authorized dealer immediately. If you need additional information and/or assistance, please contact:

LMS Customer Service Department
1462 East Ninth Street
Pomona, CA 91766.

Phone: 1-909-623-8781

Fax: 1-909-629-3890

www.calspas.com

**Please visit www.quickspaparts.com
to order your replacement parts.**