



© 2014 LMS.

2014 Owner's Manual

Special Edition Portable Spas

Built after January 1, 2014

United States and Canada

For Aqua, LES, and GII spas

Cal Spas Home Resort™



www.calspas.com

Preparing for Your New Portable Spa

Pre-Delivery Checklist	3
Planning the Best Location	3
Preparing a Good Foundation	4
240 Volt Electrical Installation	5
High Power Configuration	6
GFCI Wiring Diagram	7
120 Volt Electrical Installation	8
Testing the GFCI Breaker	8
Filling and Powering Up Your Portable Spa	9
Priming the Pump	11

Operating Your Spa

VS300 and 5100DV Control Operation	13
BP501G1 and BP501X Control Operation	19
Cal Spas Hot Tub WiFi App	27
Electrical Power Efficiency	28
Jets	28
LED Perimeter Lighting	28
Diverter Knobs	29
Waterfalls	29
Air Venturis	29

Water Clarity

The Key to Clear Water	30
Testing and Adjusting Spa Water	31
Sanitation	32
Bather Load	33
Filter Cleaning	33
Pure Cure™ Water Sanitizer	34
Ozonator	34
Maintenance Schedule	35
Troubleshooting Water Clarity Problems	36

Cleaning and Maintenance

Removing and Reseating the Pillows	37
Jet Removal and Replacement	37
Spa Cover	37
Draining Your Portable Spa	38
Winterizing (Cold Climate Draining)	39
Cleaning and Replacing the Filter	40
Vacation Care	40
Cleaning Your Spa	40
Changing the UV Lamp	41

Using the Entertainment System

Aquatic AV AQ-DM-3B Media Locker	42
Aquavibe MD-350 Docking Station	43

Appendix

Replacement Parts	45
Basic Troubleshooting	51
Limited Warranty	53
Warranty Registration	58

Copyright 2014 LMS. All rights reserved. Duplication without written consent is strictly prohibited.

Cal Spas®, Cal Premium™, Cal Select™, Cal Stone™, and Pure Cure™ are registered trademarks.

Due to continuous improvement programs, all models, operation, and/or specifications are subject to change without prior notice.

LTR20141030, Rev. A
2/18/14

100-1311

CONTACT INFORMATION

For customer service, please contact your authorized dealer immediately. If you need additional information and/or assistance, contact:

LMS Customer Service Department
1462 East Ninth Street
Pomona, CA 91766.

Toll Free: 1-800-CAL-SPAS
Fax: 1-909-629-3890

Important Safety Instructions

READ AND FOLLOW ALL INSTRUCTIONS.

DANGER -- Risk of accidental drowning:

Do not allow children to be in or around a spa unless a responsible adult supervises them. Keep the spa cover on and locked when not in use. See instructions enclosed with your cover for locking procedures.

DANGER -- Risk of injury:

The suction fittings in this spa are sized to match the specific water flow created by the pump. Should the need arise to replace the suction fittings, or the pump, be sure the flow rates are compatible.

Never operate the spa if the suction fitting or filter baskets are broken or missing. Never replace a suction fitting with one that is rated less than the flow rate marked on the original suction fitting.

DANGER -- Risk of electric shock:

Install the spa at least 5 feet (1.5 meters) from all metal surfaces. As an alternative, a spa may be installed within 5 feet of metal surfaces if each metal surface is permanently bonded by a minimum #8 AWG solid copper conductor to the outside of the spa's control box.

Do not permit any external electrical appliances, such as lights, telephones, radios, televisions, and etc., within five feet (1.5 meters) of the spa. Never attempt to operate any electrical device from inside the spa.

Replace a damaged power cord immediately.

Do not bury the power cord.

Connect to a grounded, grounding-type receptacle only.

WARNING -- To reduce the risk of injury:

The spa water should never exceed 104°F (40°C). Water temperatures between 100°F (38°C) and 104°F (40°C) are considered safe for a healthy adult. Lower water temperatures are recommended for young children and when spa use exceeds 10 minutes.

High water temperatures have a high potential for causing fetal damage during pregnancy. Women who are pregnant, or who think they are pregnant, should always check with their physician prior to spa usage.

The use of alcohol, drugs or medication before or

during spa use may lead to unconsciousness, with the possibility of drowning.

Persons suffering from obesity, a medical history of heart disease, low or high blood pressure, circulatory system problems or diabetes should consult a physician before using the spa.

Persons using medications should consult a physician before using the spa since some medications may induce drowsiness while others may affect heart rate, blood pressure and circulation.

HYPERTHERMIA DANGER:

Prolonged exposure to hot air or water can induce hyperthermia. Hyperthermia occurs when the internal temperature of the body reaches a level 3°F to 6°F above the normal body temperature of 98.6°F (or 2°C to 4°C above 37°C). While hyperthermia has many health benefits, it is important not to allow your body's core temperature to rise above 103°F (39.5°C).

Symptoms of excessive hyperthermia include dizziness, lethargy, drowsiness and fainting. The effects of excessive hyperthermia may include:

- Failure to perceive heat
- Failure to recognize the need to exit spa or hot tub
- Unawareness of impending hazard
- Fetal damage in pregnant women
- Physical inability to exit the spa
- Unconsciousness

WARNING: The use of alcohol, drugs, or medication can greatly increase the risk of fatal hyperthermia.

WARNING: People with infectious diseases should not use a spa or hot tub.

WARNING: To avoid injury, exercise care when entering or exiting the spa or hot tub.

WARNING: Do not use drugs or alcohol before or during the use of a spa or hot tub to avoid unconsciousness and possible drowning.

WARNING: Do not use a spa or hot tub immediately following strenuous exercise.

WARNING: Prolonged immersion in a spa or hot tub may be injurious to your health.

CAUTION: Maintain water chemistry in accordance with manufacturer's instructions.

SAVE THESE INSTRUCTIONS.



Preparing for Your New Portable Spa

Pre-Delivery Checklist

Most cities and counties require permits for exterior construction and electrical circuits. In addition, some communities have codes requiring residential barriers such as fencing and/or self-closing gates on property to prevent unsupervised access to the property by children. Your dealer can provide information on which permits may be required and how to obtain them prior to the delivery of your spa.

Before Delivery	
	Plan your delivery route
	Choose a suitable location for the spa
	Lay a 5 - 8 cm concrete slab
	Install dedicated electrical supply
After Delivery	
	Place spa on slab
	Connect electrical components

Planning the Best Location

Safety First

Do not place your spa within 10 feet (3 m) of overhead power lines.

Consider How You Will Use Your Spa

How you intend to use your spa will help you determine where you should position it. For example, will you use your spa for recreational or therapeutic purposes? If your spa is mainly used for family recreation, be sure to leave plenty of room around it for activity. If you will use it for relaxation and therapy, you will probably want to create a specific mood around it.

Plan for Your Environment

If you live in a region where it snows in the winter or rains frequently, place the spa near a house entry. By doing this, you will have a place to change clothes and not be uncomfortable.

Consider Your Privacy

In a cold-weather climate, bare trees won't provide much privacy. Think of your spa's surroundings during all seasons to determine your best privacy options. Consider the view of your neighbors as well when you plan the location of your spa.

Provide a View with Your Spa

Think about the direction you will be facing when sitting in your spa. Do you have a special landscaped area in your yard that you find enjoyable? Perhaps there is an area that catches a soothing breeze during the day or a lovely sunset in the evening.

Keep Your Spa Clean

In planning your spa's location, consider a location where the path to and from the house can be kept clean and free of debris.

Prevent dirt and contaminants from being tracked into your spa by placing a foot mat at the spa's entrance where the bathers can clean their feet before entering your spa.

Allow for Service Access

Make sure the spa is positioned so that access to the equipment compartment and all side panels will not be blocked.

Many people choose to install a decorative structure around their spa. If you are installing your spa with any type of structure on the outside, such as a gazebo, remember to allow access for service. It is always best to design special installations so that the spa can still be moved, or lifted off the ground.

Preparing a Good Foundation

Your spa needs a solid and level foundation. The area that it sits on must be able to support the weight of the spa, with water and the occupants who use it. If the foundation is inadequate, it may shift or settle after the spa is in place, causing stress that could DAMAGE YOUR SPA SHELL AND FINISH.

Damage caused by inadequate or improper foundation support is not covered by the warranty. It is the responsibility of the spa owner to provide a proper foundation for the spa.

Place the spa on an elevated 3 to 4" / 30 cm concrete slab. Pavers, gravel, brick, sand, timbers or dirt foundations are **not** adequate to support the spa.

We strongly recommend that a qualified, licensed contractor prepare the foundation for your spa.

If you are installing the spa indoors, pay close attention to the flooring beneath it. Choose flooring that will not be damaged or stained.

If you are installing your spa on an elevated wood deck or other structure, it is highly recommended that you consult a structural engineer or contractor to ensure the structure will support the weight of 150 pounds per square foot (732 kg / m2).

To properly identify the weight of your new spa when full, remember water weighs 8.33 lbs. per gallon, or 1 kg per liter. For example, an average 8' spa holds approximately 500 gallons, or 1892 liters, of water. Using this formula, you will find that the weight of the water alone is 4,165 lbs, or 1892 kg. Combined with the dry weight of the spa you will note that this spa will weigh approximately 5,000 lbs, or 2267 kg, when full of water.



240 Volt Electrical Installation

All 240V spas must be permanently connected (hard wired) to the power supply. See the wiring diagram on page 7.

These instructions describe the only acceptable electrical wiring procedure. Spas wired in any other way will void your warranty and may result in serious injury.

When installed in the United States, the electrical wiring of this spa must meet the requirements of NEC 70 and any applicable local, state, and federal codes.

The electrical circuit must be installed by an electrical contractor and approved by a local building or electrical inspector.

Failure to comply with state and local codes may result in fire or personal injury and will be the sole responsibility of the spa owner.

The power supplied to the spa must be on a dedicated GFCI protected circuit as required by NEC 70 with no other appliances or lights sharing the power.

Use copper wire with THHN insulation. Do not use aluminum wire.

Use the table below and on the next page to determine your GFCI and wiring requirements.

Wire runs over 85 feet must increase wire gauge to the next lower number. For example: A normal 50 amp GFCI with four #6 AWG copper wires run over 85 feet would require you to go to four #4 AWG copper wires.

GFCI and Wiring Requirements

Control System	GFCI Required	Wires Required
VS300	One 40 amp GFCI	Four #8 AWG copper wires
BP501G1 BP501X	One 50 amp GFCI	Four #6 AWG copper wires
5100DV	See section below	

Dual voltage system

The 5100DV control system is set at the factory to run on the low power setting for 40 amp operation. This is the default setting. Spa owners can have their installer change this setting so the spa will run on high power for 50 amp operation. **See configuration instructions on page 6.**

Warning: Never set a spa to run on high power without installing a properly rated GFCI.

Control System	Default setting	Power Setting	GFCI Required	Wires Required
5100DV	▶	Power saver mode Factory default	One 40 amp GFCI	Four #8 AWG copper wires
		High power setting See configuration instructions on page 6.	One 50 amp GFCI	Four #6 AWG copper wires

High Power Configuration

DIP Switch Definitions for 5100DV

OFF Position (Down)		ON Position (Up)
Test Mode OFF	◀ A1	Test mode (normally OFF)
Standard / Economy / Sleep Mode changes allowed	◀ A2	Standard Mode only
Use Digital Duplex or Light Duplex plane	◀ A3	Use Mini Panel
Pump 2 enabled	◀ A4	Pump 2 disabled
Single voltage heating (240VAC only)	A5 ▶	Dual voltage heating enabled
Safety Suction (must be OFF)	◀ A6	
See table at right	A7 ▶	See table at right
Temperature displayed in Fahrenheit	◀ A8	Temperature displayed in Celsius
No circ pump; Pump 1 is two-speed	◀ A9	Circ pump acts like Pump 1 low speed (filter cycle, polling); Pump 1 is one-speed <i>See page 16 for description of circulation pump operation.</i>
See table at right	◀ A10	See table at right

Note: Arrow indicates factory default setting.

Number of high speed pumps that can be run before heater is disabled (A5 OFF)

OR

before heater runs at 120VAC (A5 ON)

No. of Pumps	A7	A10
0	OFF	OFF
1	ON	OFF
2	OFF	ON
3	ON	ON

GFCI Wiring Diagram

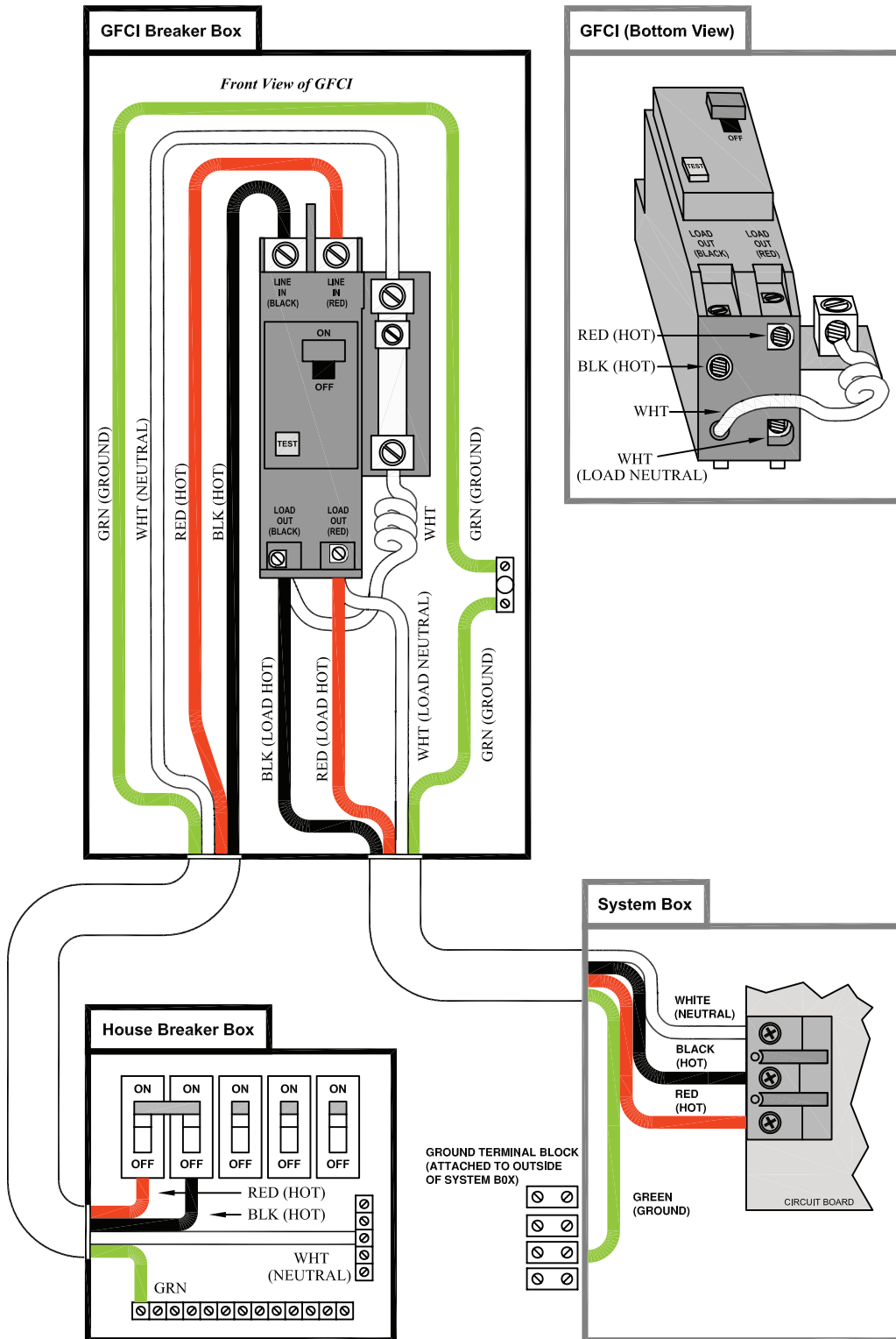

120 Volt Electrical Installation

Always follow applicable local, state and federal codes and guidelines.

Use only a dedicated electrical line with a 15 amp breaker.

Cord-and-plug connections may not use a cord longer than 15 feet (4.6 m) and must be plugged into a dedicated 15 amp GFCI connection (NEC 680.42(A) (2)). Do not use extension cords!

Always use a weatherproof-covered receptacle.

Receptacle shall be located not less than 5 feet (1.5 m) from and not exceeding 10 feet (3.0 m) from the inside wall of the spa. (NEC 680.43(A))

Do not bury the power cord. If your cord becomes damaged, replace it before next usage.

All 120V spas must have a GFCI. This can be either a 15 amp GFCI receptacle or a 15 amp GFCI cord and plug kit as shown (CKIT110 - P/N ELE09700086).

Testing the GFCI

Test the GFCI plug prior to first use and periodically when the spa is powered.

1. Plug in the GFCI into the power outlet. The indicator should turn on.
2. Press the TEST button. The GFCI will trip, the indicator will turn off, and the spa will stop operating.

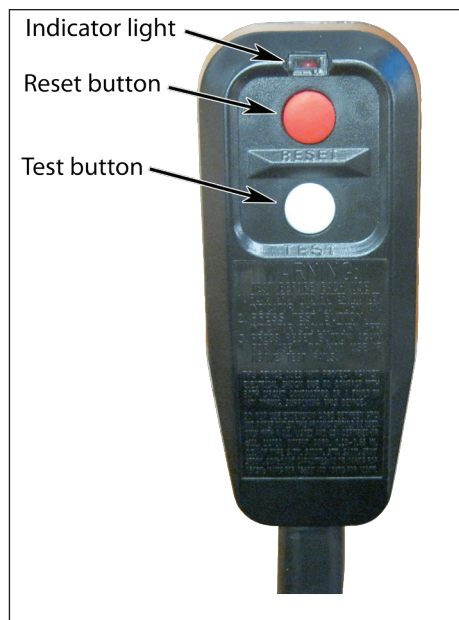

3. Press the RESET button. The GFCI will reset, the indicator will turn on again, and the spa will turn back on.

The spa is now safe to use.

If the GFCI trips while the spa is in use, press the RESET button. If the GFCI does not reset, unplug the spa and call your local Cal Spas dealer for service. **DO NOT USE THE SPA!**

Testing the GFCI Breaker

Test the GFCI breaker prior to first use and periodically when the spa is powered. To test the GFCI breaker follow these instructions (spa should be operating):

1. Press the TEST button on the GFCI. The GFCI will trip and the spa will shut off.
2. Reset the GFCI breaker by switching the breaker to the full OFF position, wait a moment, then turn the breaker back on. The spa should have power again.

Filling and Powering Up Your Portable Spa

1. Inspect the spa equipment.



After the spa has been placed on an approved surface and has been correctly wired by a licensed electrician, inspect all plumbing connections in the equipment area of your spa. Ensure that these connections are secure and that they did not loosen during shipment.

If your spa has gate valves, make sure they are all in the UP or OPEN position.

Never run the spa with the gate valves closed or without water circulating for long periods of time. Be careful not to over-tighten the plumbing fittings.

2. Remove the cartridge from filter canister.



Unscrew the cartridge and remove it.



After you remove the filter, remove the plastic wrapper and soak it in water for 30 minutes before you replace it. A dry filter can allow air into the filtration system which can cause the pump to fail to prime.

3. Fill the spa.



Place a garden hose in the filter canister and fill your spa with **regular tap water** about six inches from the top.

If the water level is too low or too high, your spa will not operate properly.



Always fill the spa through the filter canister! Failure to do so may cause air to be trapped in the filtration system and prevent the pumps from operating properly.



Never fill your spa with soft water.

Soft water makes it impossible to maintain the proper water chemistry and may cause the water to foam, which will ultimately harm the finish of the spa and void your warranty.

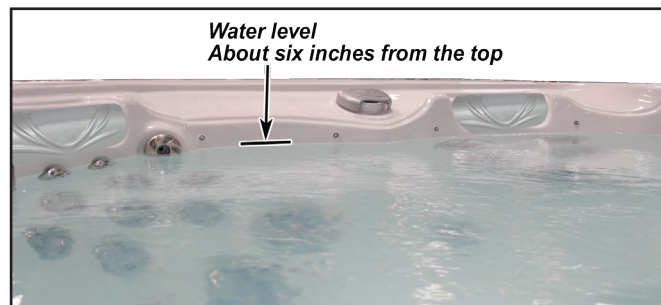

4. Turn on power to the spa.



When the spa is filled to the correct level, turn on the power at the GFCI breaker. (Ensure that the 120V spas are connected to the proper electrical outlet.)

5. Prime the pump.

For VS300 and 5100DV systems:



Your spa will perform a self-diagnostic check and go into priming mode. When the control panel displays **PR**, do the following:

- Press the JETS button to turn on the pump and let it run for 10 seconds. The pump should be running in low speed.
- Press the JETS buttons again and let the pump run in high speed for 10 seconds.
- Press the JETS button again to turn off the pump. The pump should be left off for 10 to 15 seconds.
- Repeat steps a through c until water is flowing through all the jets and all air is removed from the plumbing.

For BP501 systems



Your spa will perform a self-diagnostic check and go into Priming Mode. The control panel will display either **RUN PUMPS PURG AIR ---** or **Priming Mode**, depending on which control panel you have.

Do the following:

- Press the JETS or JETS 1 button once to start the pump in low speed.
- Press it again to switch the pump to high speed.
- If you have other pumps, press JETS 2 or JETS 3 to turn them on also.

Running the pumps helps the pumps prime.

After two minutes, the pump should prime. If it does not, follow the priming instructions on the next page. If it does, continue with the next step.

6. Install the filter into the filter canister.



Make sure the filter has soaked at least 30 minutes before you install it.

7. Let the spa heat up.

When the spa has finished priming, the heater will activate.

Put the cover on and let the spa heat up.

8. Adjust water chemistry.

After the spa has run for two hours, test and adjust the water chemistry. See the section on page 30 for instructions on water clarity.

Priming the Pump

New spa owners often have difficulty the first time they start their spa and the pump fails to prime. This can be frustrating, but these simple instructions can help you.

Sometimes air can become trapped in the pump while filling the spa. You will know this has happened when after you have filled and started the spa, the pump does not seem to function. You will hear the pump operating, but no water will be moving.



The pump will not work properly while air is trapped in it. Continuing to operate the pump in this way will cause damage.

Starting Up: Priming Mode for VS300 and 5100DV systems

Turn the spa on and wait for PR (Priming Mode) to appear on the topside display.



1. Press the JETS button to turn on the pump and let it run for 10 seconds. The pump should be running in low speed.
2. Press the JETS buttons again and let the pump run in high speed for 10 seconds.

3. Press the JETS button again to turn off the pump. The pump should be left in the off position for 10 to 15 seconds.
4. Repeat steps 1 through 4 until water is flowing through all the jets and all air is removed from the plumbing.

Note: If you press the **Temp** button any time during Priming Mode, it will exit that mode and begin Standard Mode.

Starting Up: Priming Mode for BP501 systems

After the initial start-up sequence, the spa will enter Priming Mode, which lasts 4 to 5 minutes. Depending on your control panel, the messages shown at right will appear.



As soon as the Priming Mode screen appears on the panel, press the Jets or Jets 1 button once to start Pump 1 in low speed and then again to switch to high speed. Also, select the other pumps, to turn them on. The pumps should be running in high speed to facilitate priming.

If the pumps have not primed after two minutes, and water is not flowing from the jets in the spa, do not allow the pumps to continue to run. Turn off the pumps and repeat the process. Note: Turning the power off and back on again will initiate a new pump priming session.



Priming Mode

Sometimes momentarily turning the pump off and on will help it to prime. Do not do this more than five times. If the pumps will not prime, shut off the power to the spa and call for service.

Important: A pump should not be allowed to run without priming for more than two minutes. Under NO circumstances should a pump be allowed to run without priming beyond the end of the 4 to 5 minute priming mode. Doing so may cause damage to the pump and cause the system to energize the heater and go into an overheat condition.

Exiting Priming Mode

You can manually exit Priming Mode by pressing an Up or Down button. Note that if you do not manually exit the priming mode as described above, the priming mode will be automatically terminated after 4 to 5 minutes. Be sure that the pumps have been primed by this time.

Once the system has exited Priming Mode, the top-side panel will momentarily display the set temperature but the display will not show the temperature yet. This is because the system requires approximately one minute of water flowing through the heater to determine the water temperature and display it.

Bleeding Air from the Pump

If you have tried priming the pump several times unsuccessfully using the control panel, you can bleed the air from the pump manually.

1. Shut off the power to the spa.
2. Using a Phillips screwdriver, remove the front panel from the spa and locate the pump.
3. Close the gate valve on the discharge side of the pump (if your spa is installed with one.)
4. Turn the bleeder valve counter clockwise with a small pair of pliers until the air has been released from the pump.
5. If this is unsuccessful, loosen the union nut on side of the pump with channel locks. When air is bled out, tighten the nut.
6. Turn on power to the spa and press the JETS button. If there is still air trapped in the pump, repeat steps 2 through 5 until the pump primes.

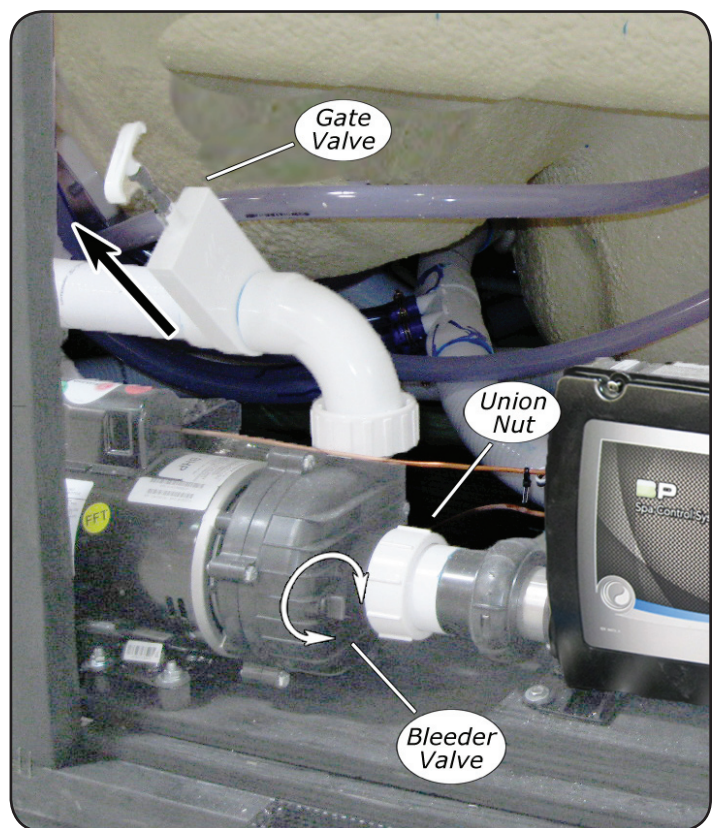

VS300 and 5100DV Control Operation

These instructions will describe features and options that your particular spa may not be equipped with.

Used for single pump systems



Used for two and three pump systems



Initial Start up

When first powered up, your spa will perform a self-diagnostic check and go into priming mode. When the control panel displays **PR**, do the following:

1. Press the **JETS** button to turn on the pump and let it run for 10 seconds. The pump should be running in low speed.
2. Press the **JETS** buttons again and let the pump run in high speed for 10 seconds.



3. Press the **JETS** button again to turn off the pump. The pump should be left in the off position for 10 to 15 seconds.
4. Repeat steps 1 through 3 until water is flowing through all the jets and all air is removed from the plumbing.

When the spa has finished priming, the heater will be activated and the water temperature will be maintained in standard mode. The spa will heat to 100°F (37.5°C) at start up until the set temperature is changed as described below.

Jet Operation: VS300 system

One Pump Systems

Single pump systems operate on high power only.

To operate the jets, press the **JETS** button:

- Once to turn the pump ON.
- Twice to turn the pump OFF.



Two and Three pump Systems

Press the **OPTION** or **JETS 2** button:

- Once to turn pump 2 ON.
- Twice to turn pump 3 ON.
- Three times to turn pump 2 OFF.
- Four times to turn pump 2 OFF.

Jet Operation: 5100DV (dual voltage) system

One Pump Systems

Single pump systems operate on high power only.

To operate the jets, press the **JETS** button:

- Once to turn the pump ON.
- Twice to turn the pump OFF.



When only one pump is running, the heater will operate at 220V. When two or three pumps are running, the heater will automatically switch to operate at 110V.

The heater light will tell you when it is operating and what voltage it is using. See the "Heater Light" section above.

For spas configured for high power operation, the heater will turn on when (1) the water temperature drops or (2) the jets are in use.

Jet Operation: Two and Three Pump Systems

Two and three pump systems can be configured to operate on low or high power. The factory default is low power. This section describes how the spa operates when it is configured for low power operation.

See page 6 for GFCI and wiring requirements for both low and high power operation and for switch settings for high power configuration.

Spas configured for low power operation require approximately 20% less power to operate. With low power configuration, the spa will never use more than 30 amps while in operation and will alternate between 110V and 220V, while spas configured for high power will operate continuously at 220V.

Operating the jets

Press the **JETS** or **JETS 1** button:

- Once to turn pump 1 ON.
- Twice to turn pump 1 OFF.

Press the **OPTION** or **JETS 2** button:

- Once to turn pump 2 ON.
- Twice to turn pump 3 ON.
- Three times to turn pump 2 OFF.
- Four times to turn pump 2 OFF.

Heating Modes

The spa can be set to operate in three different heating modes:

- **Standard:** When the spa is powered up, it will automatically start in Standard heating mode. In Standard mode, the heating system will automatically maintain the set spa temperature. **STD** or **ST** will light briefly on the main display.
- **Economy:** In Economy mode, the heating system will only activate during filtration times and will heat the water to the set temperature. **Ecn** or **Ec** will display solid if temperature is not current and will alternate with spa temperature if measured temperature is current.
- **Sleep:** In Sleep mode, the heating system will only activate the heater during the filtering cycles but will only heat the water to within 20°F (10°C) of the set temperature. Like Economy mode, **SLP** or **SL** will display solid when temperature is not current and will alternate with actual temperature when it is current.

NOTE: Displayed temperature will only be current after the pump has been running for at least two minutes.

Switching Heating Modes

- Press **Temp** button followed by the **Light** button.
- Press the same sequence to switch to the next mode.



Temperature Adjustment

(Range 80°F to 104°F, 26°C to 40°C)

The electronic control panel displays the actual water temperature in degrees Fahrenheit. The displayed temperature will only be current after the pump has been running for at least two minutes.

To set the temperature on single pump spas

- Press the **Temp** button. The temperature setting will flash.
- While the display is flashing, each time you press **Temp** button, the set temperature will change up or down one degree.
- If the desired temperature is opposite of the direction each press of the button is making, release button, allow display to stop flashing and then press **Temp** button to change temperature the other direction.



To set the temperature on two or three pump spas

- Press the **Temp UP** or **Temp DOWN** button. The temperature setting will flash.
- While the display is flashing, each time you press the **Temp UP** or **Temp DOWN** button, the set temperature will change up or down one degree.



Heater Light

The heater light will turn on whenever the heater is operating. It will appear different ways when the spa is operating:

VS300 (single voltage) system

A steady light means that the spa is operating at 220V.

A rapidly flashing light means that the heater is reading the water temperature. When the temperature has been determined, the heater light will stop flashing. You will frequently see the heater light flashing rapidly while it is also steady or slowly blinking.

5100DV (dual voltage) system

A steady light means that the spa is operating at 220V.

A slowly blinking light means that the spa is operating at 120V.

A rapidly flashing light means that the heater is reading the water temperature. When the temperature has been determined, the heater light will stop flashing. You will frequently see the heater light flashing rapidly while it is also steady or slowly blinking.

Setting Filtration Cycles

Your spa is programmed to filter twice a day. The first cycle will begin six minutes after the spa is turned on and the second cycle 12 hours later. The factory has programmed the cycle to last for two hours but this can be reset according on your requirements.

To set the time of day filtration begins, turn off the power to the spa at the time you would like one of the filtration cycles to begin, then turn back on after 30 seconds.

To set the length of filtration cycles:

- Press the **Temp** button or the **Warm/Cool** button. The temperature setting will flash.
- Press the **Jets** button. The filter cycle duration will appear.

F2 Two hours

F4 Four hours

F6 Six hours

F8 Eight hours

FC Continuous filtration



- Press **Temp** or **Warm/Cool** button to change the filtering cycle duration.
- Press the **Jets** button to exit.



If you have an ozonator, it will activate during the filtration cycles.

Light

Press the **Light** button to turn on the light. Press it once again to turn the light off. All optional lighting such as the control panel light and cabinet perimeter lighting is controlled by the **Light** button and will turn on and off with the spa light.



Automatic Time outs

These features will automatically turn themselves off during periods of continuous use:

- | | |
|-----------------------------|------------------|
| • Low speed pump | After 4 hours |
| • High speed pumps | After 15 minutes |
| • Optional circulation pump | After 15 minutes |
| • Optional turbo | After 15 minutes |
| • Spa light | After 4 hours |

Circulation Pump

This is an optional feature. If you have the optional circulation pump, it will come on when the system is checking temperature, during filter cycles, during freeze conditions, or when another pump is on.

When the circulation pump is installed, pump 1 is one-speed only. Otherwise, pump 1 is two-speed, with the low speed performing filtration. (See page 6 for control box settings.)

Diagnostic Messages for V300 and 5100DV Systems

Message	Meaning	Action Required
No message on display	<p>1) Spa temperature is unknown.</p> <p>2) Spa is in Economy or Sleep mode.</p> <p>3) Power has been cut off to the spa.</p>	<p>1) After pump has been running for 2 minutes temperature will be displayed.</p> <p>2) In Economy or Sleep mode, the pump may be off for hours outside a filter cycle. If you wish to see the current spa temperature, either switch to Standard mode or turn Jets 1 on for at least two minutes.</p> <p>3) The control panel will be disabled until power returns. Spa settings and time of day will be preserved for 30 days with a battery back-up.</p>
BUF	Internal problem detected.	Repair required. Contact your dealer or service organization.
dr	Insufficient water detected in heater. Spa will be shut down for 15 minutes.	Check water level in spa. Refill if necessary. Make sure pumps have been primed and filter cartridges are clean. Press any button to reset or wait 15 minutes and spa will automatically reset. If message spa does not reset, call your dealer or service organization.
dry dY	<p>Insufficient water detected in heater. Spa is shut down.</p> <p>(Displays on third occurrence of dr message.)</p>	Follow directions for dr message and press any button to reset spa. Spa will not automatically reset when dry or dY is displayed.
Ec	Indicates heater is in Economy Mode.	None.
--F or --C	Temperature unknown	After the pump has been running for two minutes, the temperature will be displayed.
HL HFL	A difference in readings between temperature sensors has been detected indicating a possible water flow problem.	Make sure spa is filled to proper level and that pumps are primed and filter cartridges are clean. If message does not reset, call your dealer or service organization.
IC ICE	Potential freeze condition detected.	No action required. The pumps and the blower will automatically activate regardless of spa status.
LF	<p>Persistent low flow problems. Heater is shut down, but other spa functions continue to run normally. Displays on the fifth occurrence of the HL or HFL message within 24 hours.</p>	Follow action required for HL or HFL message. Heating capacity of the spa will not reset automatically. Press any button to reset.
OH OHS	Overheat protection. The spa has shut down. One of the sensors has detected that the spa water is 110°F.	DO NOT ENTER THE WATER. Remove the spa cover and allow water to cool. At 107°F, the spa should automatically reset. If spa does not reset, shut off the power to the spa and call your dealer or service organization.

Message	Meaning	Action Required
HH OHH	Overheat protection (spa is shutdown). One sensor has detected 118°F (48°C) at the heater.	DO NOT ENTER THE WATER! Remove the spa cover and allow spa to cool below 107°F (42°C). Press any button on the topside display to reset spa. If spa will not reset after spa has cooled, turn off power for approximately 30 seconds and then turn power back on. If display message is repeated then shut the power off to the spa and call your dealer or service organization.
Pr	When your spa is first actuated, it will go into priming mode.	The priming mode will last for up to four minutes and then the spa will begin to heat and maintain the water temperature in the Standard mode.
SF	Safety Suction. Spa is shut down.	The display will show SF when a vacuum switch closes. All functions will turn off and the system will be disabled until a panel button is pressed.
SL	Indicates heater is in Sleep Mode.	None.
SA Sb SNA Snb	Spa is shut down. The sensor that is plugged into the sensor "A" or "B" jack is not working.	If the problem persists, contact your dealer or service organization. (May appear temporarily in an overheat situation and disappear when the heater cools.)
Sns Sn	Sensors are out of balance. <ul style="list-style-type: none"> • If this is alternating with the temperature, it may just be a temporary condition. • If the display shows only this message (periodically blinking), the spa is shut down. 	Contact your dealer or service organization.
ST	Indicates heater is in Standard Mode.	None.
Stby	Pressing a button combination on the user panel has activated Standby Mode.	Press any button to leave Standby Mode and return to normal operation.

BP501G1 and BP501X Control Operation



Used for single pump systems



Used for two and three pump systems

Primary Navigation and Functions

Navigating the entire menu structure is done with 2 or 3 buttons on the control panel.

You can use either Temperature button (Warm and Cool) to navigate and program where a single Temperature icon is shown.

The Light Button is also used to choose the various menus and navigate each section.

Typical use of the Temperature buttons allows changing the Set Temperature while the numbers are flashing in the LCD.

Pressing the LIGHT button while the numbers are flashing will enter the menus.



Jets Aux Warm Cool Light

The menus can be exited with certain button presses. Waiting several seconds in any screen will allow the display to revert to the main screen.

Most changes are not saved unless the Light button is pressed.

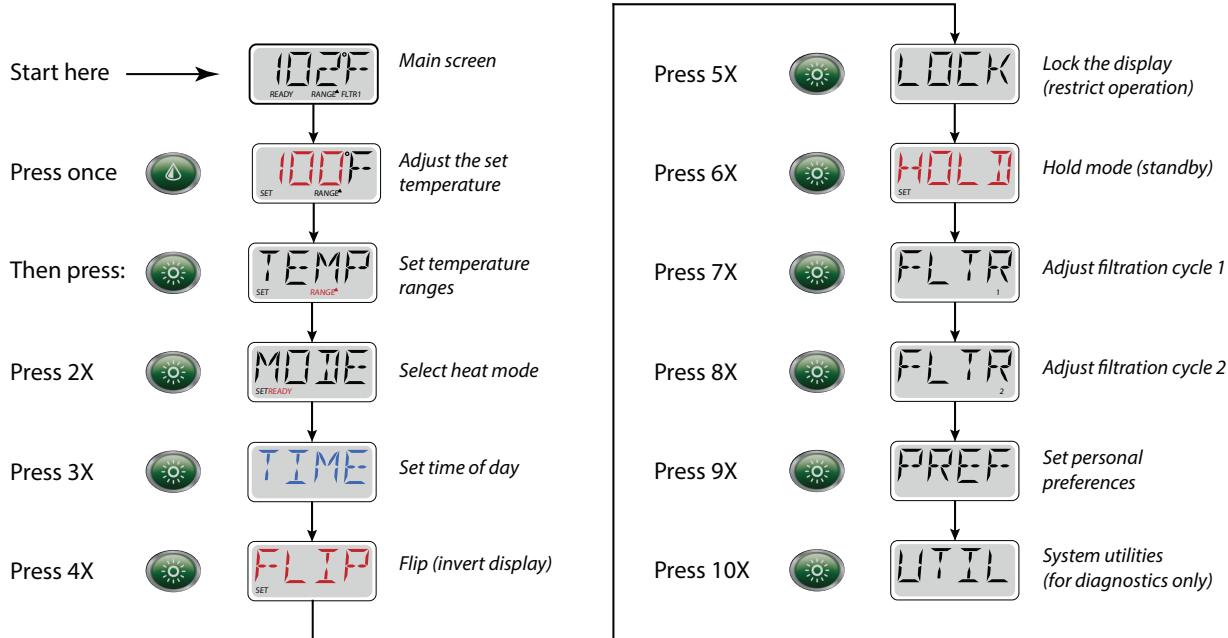

Adjusting the Set Temperature

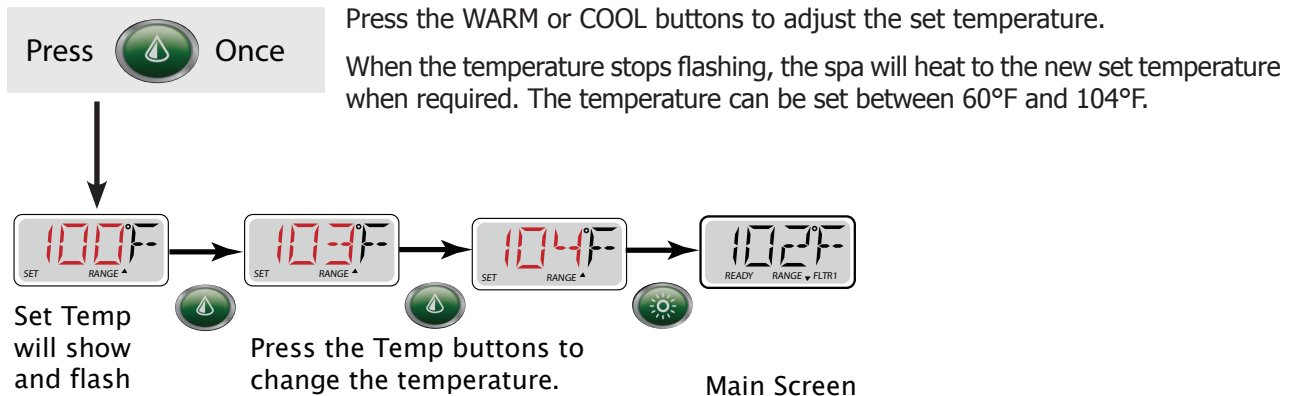

Setting Dual Temperature Ranges

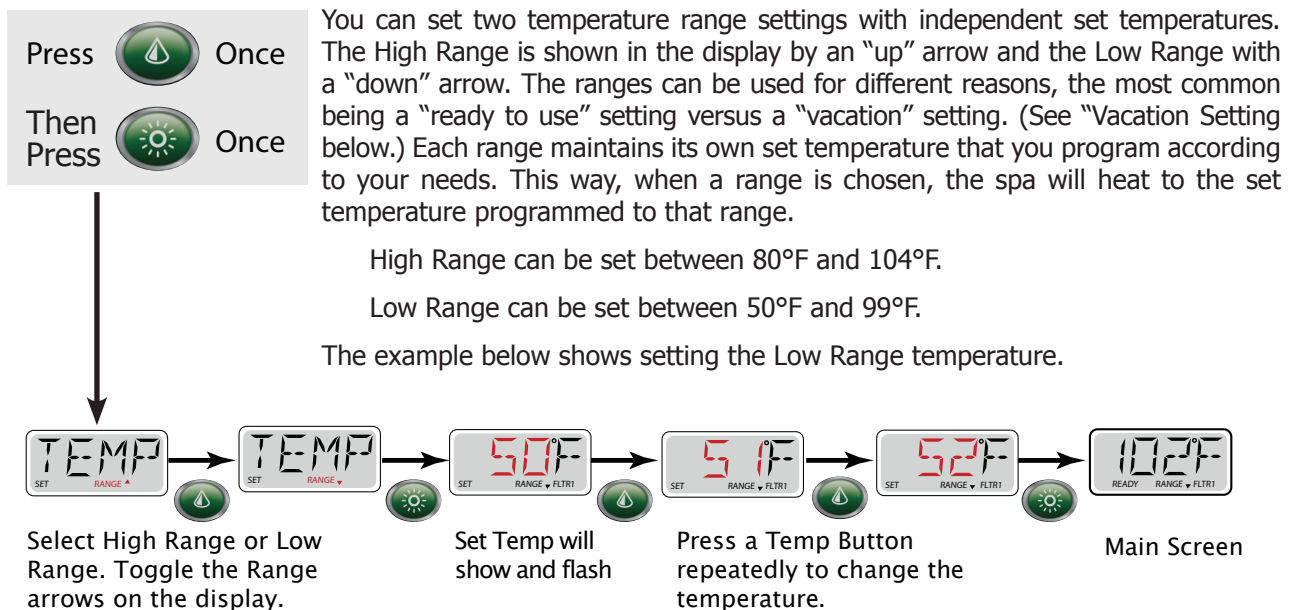



Vacation Setting

Set the spa to operate in the Lower Range temperature choice before you go on vacation.

1. Press the Temp button. The "Set Temp" will show and flash.
2. Press the Light button. "TEMP" will show on the display, which give you the choice of High Range or Low Range.
3. To set the Low Range, press the Light button, then press the Temp button. The "Set Temp" will show and flash.
4. Press the Temp buttons to adjust the temperature.
5. Press the Light button or wait several seconds to return to the main screen.

Setting the Heat Mode

Press  Once
 Then Press  Twice

There are two heat modes: READY Mode and REST Mode.

READY Mode: In order for the spa to heat, a pump needs to circulate water through the heater. The pump that performs this function is known as the "heater pump."

The heater pump can be either a 2-Speed Pump 1 or a circulation pump. If the heater pump is a 2-Speed Pump 1, READY Mode will circulate water every 1/2 hour, using Pump 1 Low, in order to maintain a constant water temperature, heat as needed, and refresh the temperature display. This is known as "polling."

REST Mode: REST Mode will only allow heating during programmed filter cycles. Since polling does not occur, the temperature display may not show a current temperature until the heater pump has been running for a minute or two.

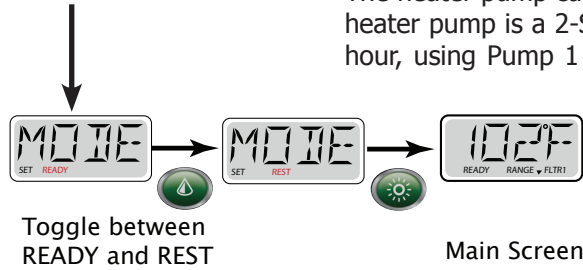

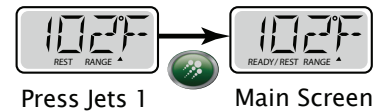

Ready-in-Rest Mode

READY/REST appears in the display if the spa is in Rest Mode and Jet 1 is pressed. When the spa is being used, it will heat to set temperature. While Pump 1 High can be turned on and off, Pump 1 Low will run until set temperature is reached, or 1 hour has passed. After 1 hour, the system will revert to Rest Mode. This mode can also be reset by entering the Mode Menu and changing the Mode.



Setting Time



Press  Once
 Then Press  3X

Setting the time of day is important for determining filtration times and other background features. 24-hour time display can be set under the PREF menu.

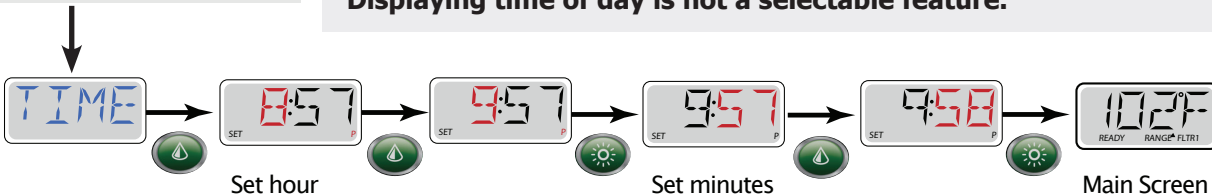
Note: This system does NOT display the time of day. The default display on the Main Screen is the current water temperature. Displaying time of day is not a selectable feature.





Flip (Invert Display)

Press  Once
 Then Press  4X

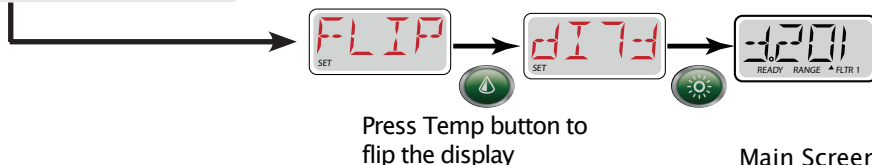
Inverting the display allows you to be able to read the control panel while you are in the spa.



Locking the Control

Press  Once
Then Press  5X

The control can be locked to prevent unwanted use or temperature adjustments. You can lock the set temperature or the control panel.

Locking the temperature allows Jets and other features to be used, but the Set Temperature and other programmed settings cannot be adjusted.

Locking the panel prevents the controller from being used, but all automatic functions are still active.

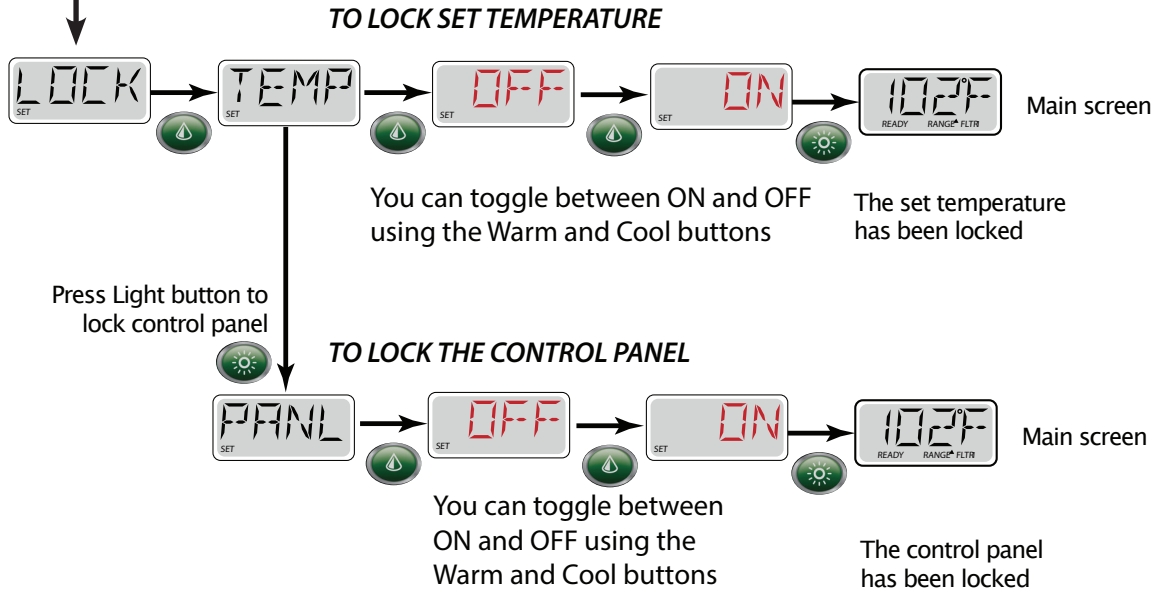

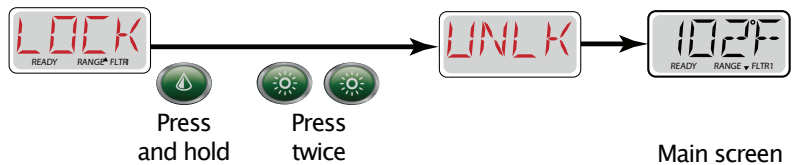

Unlocking the control

While pressing and holding the WARM Button, press the LIGHT button twice.



Hold Mode

Press  Once
Then Press  6X

Hold Mode is used to disable the pumps during service functions like cleaning or replacing the filter. (See page 33 for instruction on cleaning the filter.)

Hold Mode will last for 1 hour unless the mode is exited manually.



Adjusting Filtration

Press Once
 Then Press 7X

Main Filtration

Filter cycles are set using a duration. Each setting can be adjusted in 15-minute increments. Filter Cycle 1 and Filter Cycle 2 (if enabled) are set to the same duration.

If Filter Cycle 2 is enabled, Filter 2 will appear in the LCD. If Filter 2 is disabled, Filter 1 will appear.

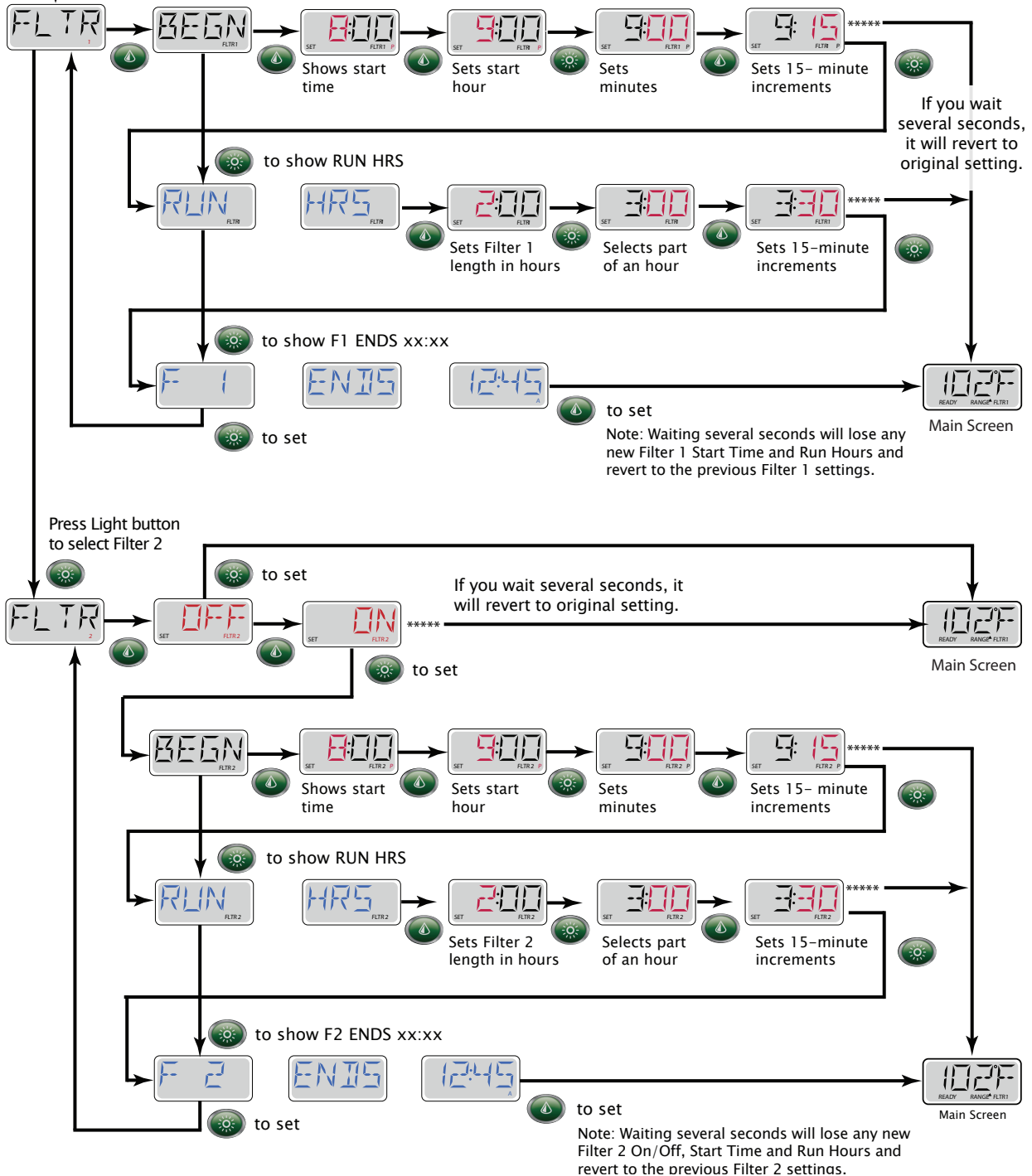

Setting Preferences

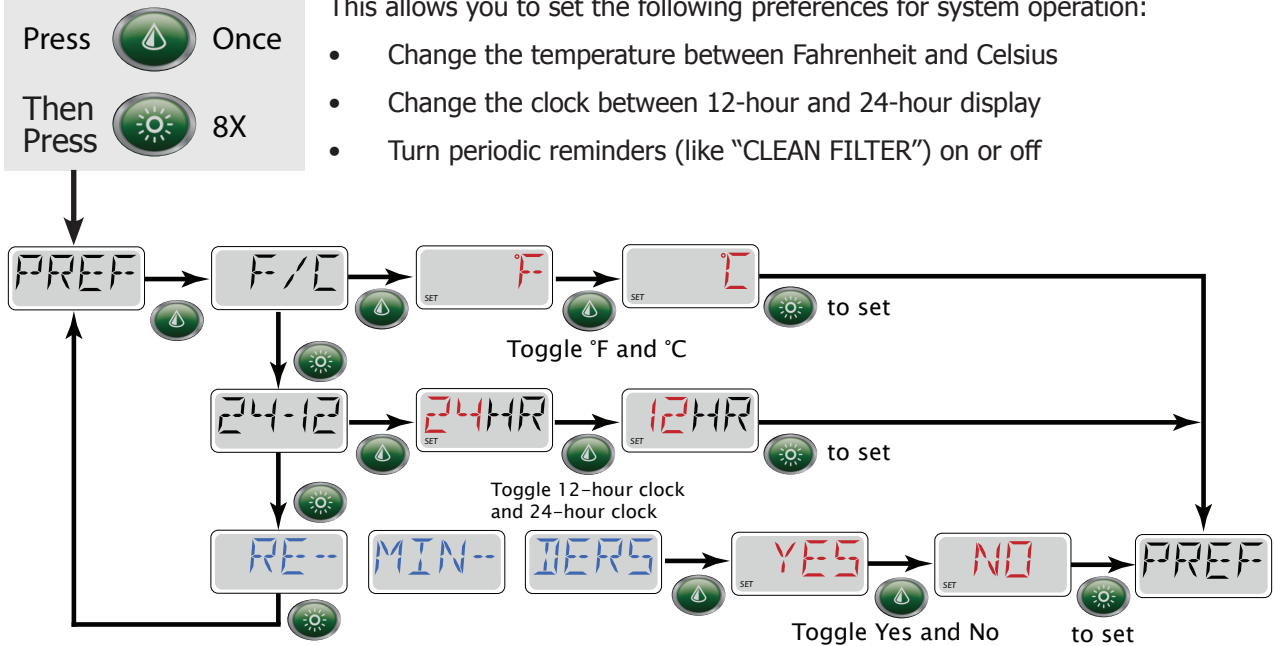

Utilities

This menu feature is for system information only and is used mainly for repair and troubleshooting.

Other Spa Systems

Several spa functions operate in the background and require no action or maintenance from you. This is for your information only.

Pumps

Press the "Jets 1" button once to turn pump 1 on or off, and to shift between low- and high-speeds if equipped. If left running, the pump will turn off after a time-out period. The pump 1 low-speed will time out after 30 minutes. The high-speed will time out after 15 minutes.

On non-circ systems, the low-speed of pump 1 runs when the blower or any other pump is on. If the spa is in Ready Mode, Pump 1 low may also activate for at least 1 minute every 30 minutes to detect the spa temperature (polling) and then to heat to the set temperature if needed. When the low-speed turns on automatically, it cannot be deactivated from the panel, however the high speed may be started.

Circulation Pump

The circulation pump will come on when the system is checking temperature (polling), during filter cycles, during freeze conditions, or when another pump is on.

The ozonator will run with the circulation pump during filtration cycles.

Freeze Protection

If the temperature sensors within the heater detect a low enough temperature, then the pump(s) and the blower automatically activate to provide freeze protection. The pump(s) and blower will run either continuously or periodically depending on conditions.

In colder climates, an optional additional freeze sensor may be added to protect against freeze conditions that may not be sensed by the standard sensors. Auxiliary freeze sensor protection acts similarly except with the temperature thresholds determined by the switch. See your dealer for details.

Purge Cycles

In order to maintain sanitary conditions, secondary Pumps and/or a Blower will purge water from their respective plumbing by running briefly at the beginning of each filter cycle.

Diagnostic Messages for BP501 Systems

Message	Meaning	Action Required
RUN PMPS PURG AIR	<p>Priming Mode</p> <p>Each time the spa is powered up, it will enter Priming Mode. The purpose of Priming Mode is to allow the user to run each pump and manually verify that the pumps are primed (air is purged) and water is flowing. This typically requires observing the output of each pump separately, and is generally not possible in normal operation.</p>	<p>Priming Mode lasts 4 minutes, but you can exit it earlier by pressing any Temp button. The heater is not allowed to run during Priming Mode.</p> <p>NOTE: If your spa has a Circ Pump, it will turn on with Jets 1 in Priming Mode. The Circ Pump will run by itself when Priming Mode is exited.</p>
---F - ---C	<p>Water Temperature Is Unknown</p> <p>After the pump has been running for 1 minute, the temperature will be displayed.</p>	None
42F TOO COLD	<p>Too Cold - Freeze Protection</p> <p>A potential freeze condition has been detected, or the Aux Freeze Switch has closed, and all pumps and blower are activated. All pumps and blower are ON for at least 4 minutes after the potential freeze condition has ended, or when the aux freeze switch opens. In some cases, pumps may turn on and off and the heater may operate during Freeze Protection.</p>	None.
WATR TOO HOT	<p>Water is Too Hot</p> <p>One of the water temp sensors has detected spa water temp 110°F (43.3°C) and spa functions are disabled.</p>	None. System will auto reset when the spa water temp is below 108°F (42.2°C). Check for extended pump operation or high ambient temp.
SFTY TRIP ----	<p>Safety Trip - Pump Suction Blockage</p> <p>The Safety Trip error message indicates that the vacuum switch has closed. This occurs when there has been a suction problem or a possible entrapment situation avoided. (Note: not all spas have this feature.)</p>	Drain or filter may be covered, creating a blockage. Clear the blockage and reset by pressing any button on the topside panel.
HTR FLOW LOSS ----	<p>Heater Flow Is Reduced</p> <p>There may not be enough water flow through the heater to carry the heat away from the heating element.</p>	Check for low water level, suction flow restrictions, closed valves, trapped air, too many closed jets and pump prime. Heater start up will begin again after about 1 minute.
HTR FLOW FAIL ----	<p>Heater Flow is Reduced</p> <p>There is not enough water flow through the heater to carry the heat away from the heating element and the heater has been disabled.</p>	Check for low water level, suction flow restrictions, closed valves, trapped air, too many closed jets and pump prime. Heater start up will begin again after about 1 minute.

Message	Meaning	Action Required
HTR MAY BE DRY ---- WAIT ----	Heater May Be Dry Possible dry heater, or not enough water in the heater to start it. The spa is shut down for 15 min.	Check for low water level, suction flow restrictions, closed valves, trapped air, too many closed jets and pump prime. Press any button to reset the heater start-up.
HTR DRY ----	Heater Is Dry There is not enough water in the heater to start it. The spa is shut down.	Check for low water level, suction flow restrictions, closed valves, trapped air, too many closed jets and pump prime. Press any button to reset the heater start-up.
HTR TOO HOT ----	Heater Is Too Hot One of the water temp sensors has detected 118°F (47.8°C) in the heater and the spa is shut down.	Check for low water level, suction flow restrictions, closed valves, trapped air, too many closed jets and pump prime. Press any button to reset when water is below 108°F (42.2°C).
PRES BTTN TO RSET ----	Spa Needs To Be Reset This message may appear with other messages.	Press any button on the topside control to reset.
102F SNSR BAL- ANCE	Sensor Balance Is Poor The temperature sensors MAY be out of sync by 2°F or 3°F.	Call for service.
SNSR SYNC ---- CALL FOR SRVC ----	Sensor Balance is Poor The temperature sensors ARE out of sync.	Call for service. Note: This message can be reset from the topside panel with any button press.
SNSR A ---- CALL FOR SRVC SNSR B ---- CALLFOR SRVC	Sensor Failure A temperature sensor or sensor circuit has failed.	Call for service.
NO COMM	No Communications The control panel is not receiving communication from the system.	Call for service.
102°T	°F or °C is replaced by °T The control system is in Test Mode.	Call for service.
STUK PUMP ----	A Pump Appears To Be Stuck ON Water may be overheated.	POWER DOWN THE SPA. DO NOT ENTER THE WATER. Call for service.
HOT FALT ---- CALL FOR SRVC ----	A Pump Appears To Be Stuck ON A pump appears to have been stuck ON when spa was last powered.	POWER DOWN THE SPA. DO NOT ENTER THE WATER. Call for service.

Cal Spas Hot Tub WiFi App

This optional feature is available for use with any smart device (Android™ or iPhone™). You must have the wifi module installed in your spa in order to use the app.

This feature is only available for spas with the BP501 control box.

Installing the app

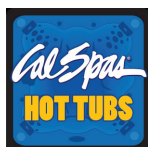

Go to the Apple app store or Google Play and search for the free spa app using the key words "Cal Spas Hot Tubs." Select the "Cal Spas Hot Tubs" icon. It will appear on your device as shown at left.

Make sure you enable wifi on your phone before you run the app.

Once you are connected to the BWG Spa network, start the Cal Spas Hot Tub app and follow the prompts on the screen. (Your start screen maybe different.)

1. Press the Cal Spas app button on the main screen of your device.
2. Connect to the spa's wifi signal.
3. When connected, you will be taken to the main app screen.
4. You are now directly connected to your hot tub and can control all the hot tub functions via the Cal Spas Hot Tub app.

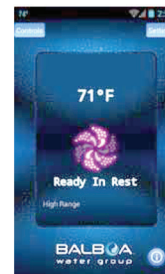
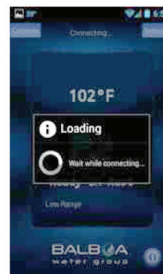
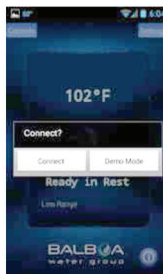
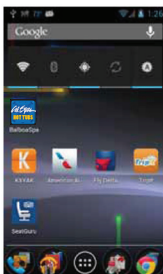

Using the app

When the app has been installed, it will provide you with instant access and control of your spa wherever you connect within the spa's Wi-Fi range.

The controls are visually oriented and require little explanation. You can find more in-depth instructions in the Wi-Fi Setup Guide at the Balboa web site:

<http://www.balboawatergroup.com/bwa>

Troubleshooting connection problems

You should have few problems connecting with the bwa wifi app. However, if you are unable to connect quickly and easily to the spa's wifi source, try doing the following.

- Enable on your device. This is the most likely reason you may not be able to connect to the app. Check your devices wifi settings and try connecting again.
- Power cycle the spa. Shut off power to the spa for 30 second and turn it back on. Wait until the spa has gone through its complete set-up routine before you try to connect with the wifi app.
- Wait until the spa has completely primed. When you turn on the spa, it will go through a priming routine, which is followed by temperature polling, where no temperature is shown on the control panel. As soon as a temperature appears, you can connect with the wifi app.

Electrical Power Efficiency

Your new spa comes equipped with an electric heater. Following the directions listed below will ensure the most efficient operation:

NOTE: This method is only for spa usage under two hours a week.

- Keep the spa's operating temperature 5°F below the desired usage temperature when not in use. One or two hours before use, set the temperature to the desired temperature.
- If the spa usage exceeds two hours a week, the set temperature should remain at the desired usage temperature.
- The air venturis should be used sparingly. When open, water temperature drops quite rapidly and can also dissipate chemicals.

Allowing the water temperature to lower more than 10°F below the desired usage temperature and reheating it prior to usage will cause the heater to operate longer than it normally would maintaining the desired temperature. Doing this will increase your operating cost and makes your heater work more than necessary.

Jets

Almost all of the jets in your spa are adjustable. Rotating the face of an adjustable jet to the left (counter-clockwise) will decrease the amount of water flow through the jet. Rotating the face of an adjustable jet to the right (clockwise) will increase the amount of water flow through the jet. (See example shown below.)

Neck jets adjust in the opposite directions (counter-clockwise to increase, clockwise to decrease).



LED Perimeter Lighting

Press the LIGHT button on the topside control panel to turn the spa light on. If your spa has perimeter LED lights, they will also light up at the same time as the spa light.

The perimeter lights operate in three modes:

- 1. Cycle:** The first time you press the LIGHT button, the lights will cycle through all the colors in this order:

White
Cyan
Magenta
Blue

Yellow/green
Green
Red

To cycle through the different color choices, press the button repeatedly. Each time you press the button, you advance to the next color.

- 2. Flashing white:** When you have cycled through all the colors, the next time you push the LIGHT button, the LED lights will flash white.
- 3. Fading cycle:** The next time you push the LIGHT button, the lights will gradually fade from one color to the next in the order shown above.

Diverter Knobs

Diverter knobs are 1" and 2" knobs located around the top of your spa. They allow you to divert water through jets from one side of the spa to the other, or in most cases from floor jets to wall jets. This is accomplished by rotating the diverter knob to the left (counterclockwise), decreasing the amount of water flow through a section of jets. To increase the amount of water flow through the other section of jets, rotate the handle to the right (clockwise).



Air Venturis

Air venturis are the 1" knobs located around the top of your spa. Each one will let you add a mixture of air with the jet pressure. This is accomplished by rotating the air venturi knob to the left (counterclockwise) to increase the amount of airflow through the jets. To decrease the amount of airflow through the jets, rotate the handle to the right (clockwise).



Waterfalls

When the booster pump is on, rotate the dial on top of the waterfall. Water will immediately start flowing through it.



Water Clarity

This section is intended for new spa owners with no experience with water chemistry. Everyone's experience with maintaining water quality is different, but there are some general concepts you need to know.

Water maintenance is not difficult, although it requires regular attention. The most important thing to understand about taking care of your spa water is that preventive action is much easier than correcting water quality issues.

The Key to Clear Water

Excellent water quality is a simple matter of four things:

Chemical Balance

You will need to test and adjust the chemical balance of your spa water. Although this is not difficult, it needs to be done regularly.

Depending on your choice of sanitizer, you need to test the level of calcium hardness, total alkalinity, and pH.

See page 31 to learn how to balance your spa water.

Sanitation

Sanitizers kill bacteria and viruses and keep the water clean. A low sanitizer level will allow microbes to grow quickly in the spa water. We recommend using either chlorine or bromine as your sanitizer.

Spa owners with an ozonator also need to add sanitizer, although their requirements are different.

See page 32 to learn how to use sanitizer.

Filtration

Cleaning your filter regularly is the easiest and most effective single thing you can do to keep your water clear.

A clogged or dirty filter will cause the heater and pump to work harder than they need to, possibly causing them to fail.

The spa's heating system will only function with the proper amount of water flow through the system.

See page 33 for filter cleaning instructions.

Regularity

Clear water requires regular maintenance. Establish a routine based on a regular schedule for your spa water maintenance.

Maintaining your water quality helps the enjoyment of your spa and extends your spa's life by preventing damage from neglect and chemical abuse.

See page 35 for the schedule of recommended maintenance.



Testing and Adjusting Spa Water

You have two types of testing methods to choose from:

- **The reagent test kit** is a method which provides a high level of accuracy. It is available in either liquid or tablet form.
- **Test strips** are a convenient testing method commonly used by spa owners.

Balancing the Total Alkalinity

Total alkalinity (TA) is the measure of the total levels of carbonates, bicarbonates, hydroxides, and other alkaline substances in the water. TA can be considered a "pH buffer". It is the measure of the ability of the water to resist changes in pH level.

The recommended total alkalinity is 80 - 120 ppm.

If the TA is too low, the pH level will fluctuate widely from high to low. Low TA can be corrected by adding an alkalinity increaser

If the TA is too high, the pH level will tend to be too high and may be difficult to bring down. High TA can be corrected by adding an alkalinity decreaser.

When the TA is balanced, it normally remains stable, although adding water with high or low alkalinity will raise or lower the TA level.

Balancing the Calcium Hardness

Calcium hardness (CH) is a measure of the total amount of dissolved calcium in the water. Calcium helps control the corrosive nature of the spa's water and is why soft water is not recommended. The low calcium content of soft water is very corrosive to the equipment and can cause staining of the spa shell.

The recommended calcium hardness is 150 - 200 ppm.

If the CH is too low, add a calcium hardness increaser.

If the CH is too high, dilute the spa water with soft water.

When the CH is balanced, it normally remains stable, although adding soft water or very hard water will raise or lower the CH level.

Balancing the pH

The pH level is the measure of the balance between acidity and alkalinity.

If the pH is too low, it can cause corrosion of metal fixtures and the heating element. Low pH can be corrected by adding a pH increaser.

If the pH is too high, it can cause scaling by allowing metals or minerals to form deposits and stain spa surfaces. High pH can be corrected by adding a pH decreaser.

Ideal Water Chemistry

Testing For:	Ideal Range (ppm)	
	Minimum	Maximum
Total Alkalinity	80	120
Calcium Hardness	150	200
pH	7.2	7.6

Sanitation

Sanitizers kill bacteria and other organic waste by breaking them down to non-harmful levels and are filtered out. Before you fill your spa, you need to decide which chemical sanitizer you wish to use. Consult your Cal Spas dealer for the right decision with regards to your lifestyle and spa usage.

We recommend either **bromine** or **chlorine** as your sanitizer. Both work well when maintained regularly.



DO NOT use trichlor. Trichlor is very acidic and the hot temperature of the spa causes it to dissolve too quickly. It will cause damage to your spa and will void your warranty.

Whichever plan you decide on, follow it completely and don't take shortcuts. It will provide you with clean, safe, clear spa water with a minimum of effort. Spa owners with an ozonator still need to use a chemical sanitizer. See page 34 for a description of how the ozonator works.

Using Chlorine as a Sanitizer

If you choose to use chlorine as a sanitizer, only use granulated chlorine, not liquid chlorine.

Once a week, check the chlorine level using either a test strip or a reagent kit. See the table on the following page for the ideal range.

Add one or two tablespoons granulated chlorine to the spa water weekly. Note that chlorine dissipation rate will be faster at higher water temperatures and slower at lower temperatures.

When you add chlorine, open all of the jets and run the spa at high speed with the cover open for at least 30 minutes.

Follow the maintenance schedule on page 35.

Using Bromine as a Sanitizer

Bromine is a very effective sanitizer that produces low chemical odors. Unlike chlorine, it can break down bacteria and other impurities to a safe level with a low burn-out rate.

Bromine is available in both granulated and tablet form. Use granulated sodium bromide to establish your bromine base. Use tablets to maintain it.

When you begin with fresh water, add 2 ounces of granulated bromide. Open all of the jets and run the spa at high speed with the cover open for at least 30 minutes. This is your base bromine level as the tablets will take a while to dissolve.

Place three or four bromine tablets in your chemical floater.

Follow the maintenance schedule on page 35.

Shocking the Water

In addition to using a chemical sanitizer, you will periodically need to shock the water. Shocking the water helps remove burned-out chemicals, bacteria, and other organic material from your spa's water and improves your sanitizer's effectiveness.

Do not use chlorinating shock, which will damage your spa's jets and pump seals. Only use an oxidizer shock. It can be used with either chlorine or bromine sanitizers.

Add one ounce of oxidizer shock once a week, after heavy bather loads, or if water has a strong odor.

Spa must be running with all of the jets on high for 30 minutes with the cover open. If necessary, repeat oxidizer shock in 30 minute intervals.

Testing For:	Ideal Range (ppm)	
	Minimum	Maximum
Chlorine level		
Without ozonator	3.0	5.0
With ozonator	2.0	4.0
Bromine level		
Without ozonator	6.7	11.0
With ozonator	5.7	10.0

Bather Load

“Bather Load” is the term used to describe the number of people using a spa, combined with the length of usage, and the frequency of usage. All these factors have a great effect on the spa water. The higher the bather load, the more chemicals need to be added and a longer filtration time will be needed.

Recommendations are designed for spas with average bather load (3 to 4 people, 15 minutes of usage, three times a week at 100 degrees) If your bather load exceeds these guidelines, and you experience water quality problems, increase the amount of filtration first, (go to the next higher filtration number) then if water quality is still not adequate, consult the advice of your Cal Spas dealer for additional chemical or system recommendations. Be sure to give them your bather load information.

Filter Cleaning

The filter is the part of your spa that removes the debris from the water and needs to be cleaned on a regular basis to maximize your spa’s filtering performance and heating efficiency.

In addition to spraying off the filter weekly to remove surface debris, your filter should be deep cleaned periodically to dissolve scale and particles that get lodged deep within the filter fibers and impede the filtration process. Even if the filter looks clean, scale and particles can clog the fibers and prevent water from flowing through the filter resulting in the most common spa problem—no heat, caused by a dirty filter.

We recommend you clean your filter once a month and replace it once a year or as necessary.

It is extremely important that you never run the spa without a filter. There is a possibility that debris may be sucked into the plumbing through the filter well.

Set the spa in Hold Mode before you remove the filter. Hold Mode pauses all spa operations for 60 minutes for service functions like cleaning or replacing the filter. See page 22 for instructions on using Hold Mode.

Cleaning the filter

1. Remove the filter by unscrewing it and pulling it up and out.
2. Place the dirty filter into a bucket of water deep enough to cover the filter. Add 8 oz of liquid filter cleaner to the bucket of water.

Note: It is a good idea to keep a spare filter to use in the spa while the dirty filter is being deep cleaned. This way, you can rotate the filters and both will last longer.

3. Soak the filter for a minimum of 24 hours.
4. Spray the filter with a water hose. Spray each pleat carefully.
5. Reinstall the filter. Do not overtighten.

Pure Cure™ Water Sanitizer

The Pure Cure™ water sanitizer is an optional water purification system installed at the factory. It eradicates germs in the water that are resistant to chlorine-based chemicals using high intensity UV light. Although the water sanitizer works automatically with your spa, you will still need to test for chlorine or bromine and occasionally replenish it to return the sanitizer level to the baseline.

For spas without a circulation pump, pump 1 will run at low speed and the water sanitizer will run during filtration.

For spas with a circulation pump, the water sanitizer will run with the circulation pump.

The spa's control system is factory-programmed with one filter cycle that will run in the evening when energy rates are often lower. The time and duration of the filter cycle can be set according to your needs. In addition, a second filter cycle can be enabled. Filtration time may need to be increased with heavy bather load.

See instructions for setting filtration cycles on page 23 or page 21.

The water sanitizer is virtually maintenance-free. Once a year the UV light needs to be replaced. See page 41 for instructions. **However, the water sanitizer is not a user-serviceable item and maintenance must be performed by a spa technician. Have your service technician consult the manufacturer's instruction and service manual.**

Ozonator

The ozone generator releases ozone into the spa water. You will still need to test for chlorine or bromine and occasionally replenish it to return the sanitizer level to the baseline.

For spas without a circulation pump, pump 1 will run at low speed and the ozonator will run during filtration.

For spas with a circulation pump, the ozonator will run with the circulation pump.

The spa's control system is factory-programmed with one filter cycle that will run in the evening when energy rates are often lower. The time and duration of the filter cycle can be set according to your needs. In addition, a second filter cycle can be enabled. Filtration time may need to be increased with heavy bather load.

See instructions for setting filtration cycles on page 23 or page 21.

Maintenance Schedule

Each time you refill the spa	Follow the section "Filling and Powering Up Your Portable Spa" on page 9.
Prior to each use	Test the spa water using either test strips a reagent test kit. Adjust chemical levels as necessary.
Once a week	Test the spa water using either test strips a reagent test kit. Adjust chemical levels as necessary. If your water source is high in calcium, add stain and scale preventer.
Once a month	Deep clean your spa's filter. (Follow filter cleaning instruction at beginning of this section)
Every two to four months	Change the spa water. How often you change the water depends on how much you use the spa. When you change the water, you will need to: <ul style="list-style-type: none"> • Clean and polish the acrylic surface (see page 40) • Clean and treat the spa cover and pillows (see page 40) • Deep clean the filter (see page 33) • Refill your spa (see page 9)
Once a year	Replace filter cartridges if the pleats appear frayed. If you use the Cal Pure UV water sanitizer, you will need to replace the UV lamp (see page 41 for UV lamp maintenance)

Troubleshooting Water Clarity Problems

Problem	Probable Causes	Possible Solutions
Cloudy Water	<ul style="list-style-type: none"> • Dirty filter • Excessive oils / organic matter • Improper sanitization • Suspended particles / organic matter • Overused or old water 	<ul style="list-style-type: none"> • Clean filter • Shock spa with sanitizer • Add sanitizer • Adjust pH and/or alkalinity to recommended range • Run jet pump and clean filter • Drain and refill the spa
Water Odor	<ul style="list-style-type: none"> • Excessive organics in water • Improper sanitization • Low pH 	<ul style="list-style-type: none"> • Shock spa with sanitizer • Add sanitizer • Adjust pH to recommended range
Chlorine Odor	<ul style="list-style-type: none"> • Chloramine level too high • Low pH 	<ul style="list-style-type: none"> • Shock spa with sanitizer • Adjust pH to recommended range
Musty Odor	<ul style="list-style-type: none"> • Bacteria or algae growth 	<ul style="list-style-type: none"> • Shock spa with sanitizer – if problem is visible or persistent, drain, clean and refill the spa
Organic buildup / scum ring around spa	<ul style="list-style-type: none"> • Buildup of oils and dirt 	<ul style="list-style-type: none"> • Wipe off scum with clean rag – if severe, drain the spa, use a spa surface and tile cleaner to remove the scum and refill the spa
Algae Growth	<ul style="list-style-type: none"> • High pH • Low sanitizer level 	<ul style="list-style-type: none"> • Shock spa with sanitizer and adjust pH • Shock spa with sanitizer and maintain sanitizer level
Eye Irritation	<ul style="list-style-type: none"> • Low pH • Low sanitizer level 	<ul style="list-style-type: none"> • Adjust pH • Shock spa with sanitizer and maintain sanitizer level
Skin Irritation / Rash	<ul style="list-style-type: none"> • Unsanitary water • Free chlorine level above 5 ppm 	<ul style="list-style-type: none"> • Shock spa with sanitizer and maintain sanitizer level • Allow free chlorine level to drop below 5 ppm before spa use
Stains	<ul style="list-style-type: none"> • Total alkalinity and/or pH too low • High iron or copper in source water 	<ul style="list-style-type: none"> • Adjust total alkalinity and/or pH • Use a stain and scale inhibitor
Scale	<ul style="list-style-type: none"> • High calcium content in water – total alkalinity and pH too high 	<ul style="list-style-type: none"> • Adjust total alkalinity and pH – if scale requires removal, drain the spa, scrub off the scale, refill the spa and balance the water • Use a stain and scale inhibitor

Removing and Reseating the Pillows

You can remove the pillows for cleaning and maintenance quickly and easily. This method works for all types of pillows.

Grab the lower edge of the pillow with both hands firmly and pull up. As you do this, the pillow inserts will pop out of the holes.

Reseat the pillows by aligning the pillow inserts with the holes and striking the pillow hard enough to insert the pegs back into the holes.

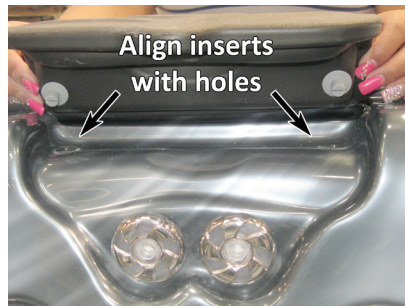

Jet Removal and Replacement

Jets can be easily removed for cleaning.

Grasp the outer rim of the jet and turn it counter-clockwise. The jet will unscrew from the fitting until it is free.

To replace the jet, place it in the fitting and turn it clockwise until it is snug in place. Do not overtighten the jet.

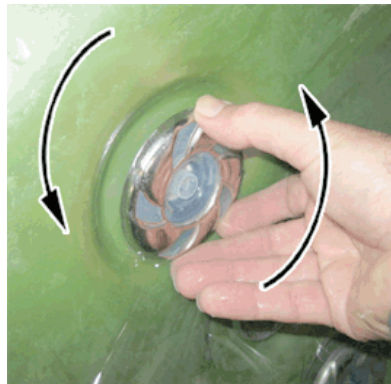

Spa Cover

Important! Keep the spa covered when not in use!

- Covered spas will use less electricity in maintaining your set temperature.
- Covering your spa will protect your spa's finish from the sun's ultraviolet rays.
- You are required to keep the spa covered to maintain warranty coverage.
- Covering your spa helps prevent children from drowning in the spa.

See the manual enclosed with your cover for instructions on mounting the locks and how to lock and unlock the cover.

In addition, while the spa cover is rigid, it is not designed to support any weight. Therefore, as a safety precaution and to preserve the life of your cover, you must not sit, stand, or lie on it, nor should you place objects of any kind on top of it.

Draining Your Portable Spa

Your spa should be drained every four to six months, and refilled with fresh tap water. The following is the recommended method for draining your spa.

For spas with cabinet mounted drain:

1. Turn off the power at the breaker.
2. Remove all filters.
3. Pull the knob out about 2" until it snaps into place.

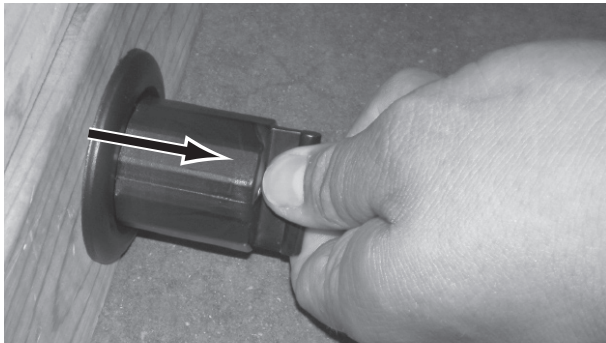

4. Unscrew the cap.

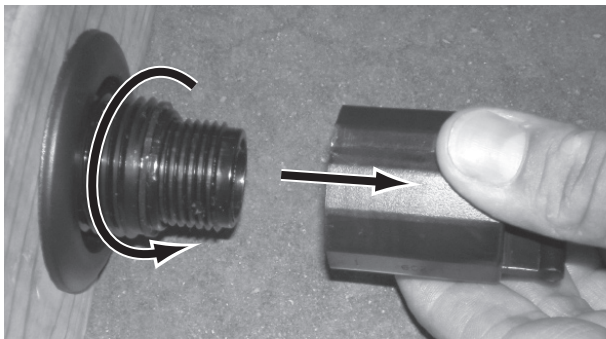

6. Place the other end of the garden hose where you would like the water to drain to.
7. Pull the hose outward about 1/2" to start water flow. Push inward to shut off water flow.

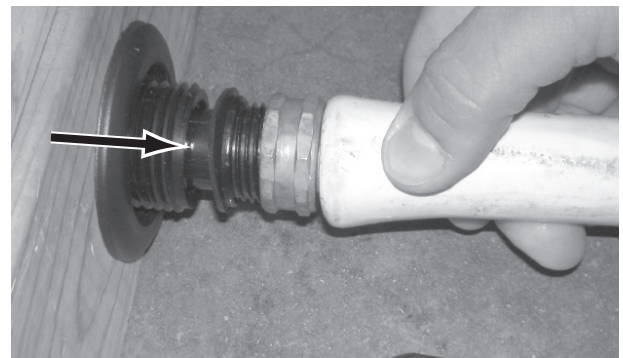

5. Hook up the female end of a garden hose to the drain fitting.

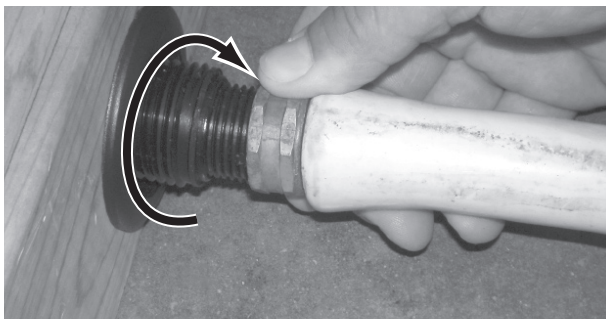

8. Let spa drain completely.
9. Push the hose inward about 1/2 inch, then remove the garden hose.
10. Replace the cap.
11. Push the knob in about 2" until it snaps back into place.

For spas with drain inside the spa:

1. Turn off the power at the breaker.
2. Remove all filters.
3. Using a Phillips screwdriver, remove the screws to the access panel and open it.
4. Locate hose ending with the $\frac{3}{4}$ inch hose-bib fixture.
5. Unscrew the cap.
6. Hook up the female end of a garden hose to the drain fitting.
7. Place the other end of the garden hose where you would like the water to drain to.
8. Turn the valve on the hose-bib fixture to open the drain.
9. Let spa drain completely, then remove garden hose.
10. Turn the valve on the hose-bib fixture to close the drain.
11. Replace the cap.

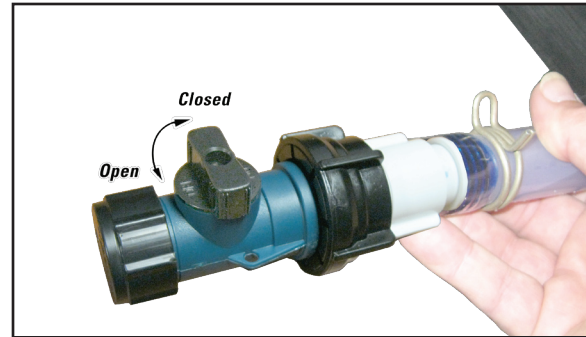

Winterizing (Cold Climate Draining)

In many areas of the country, the temperature drops below 32°F (0°C). We recommend that you always have your spa full of water and running at normal spa temperatures (80°F to 100°F, 26.7°C to 37.8°C). This will help reduce the risk of freezing in your spa and your spa's equipment.

Warning: If you find the need to drain your spa, be aware of the potential of freezing in your spas equipment and plumbing. Even if the directions below are followed perfectly, there is no guarantee that your spa will not suffer freeze damage.

Freeze damage is not covered by your warranty.

1. Open all filter covers.
2. Remove the filter baskets and filters.
3. Drain your spa completely as described in the instructions above.
4. Vacuum water from the spa's main drain fitting with a wet/dry vacuum.
5. Remove drain plugs from the front of the pumps.
6. Disconnect the unions from both sides of the pump.
7. Blow any remaining water out of the jets and equipment area with the wet/dry vacuum.
8. Cover your spa with a good spa cover and an all-weather tarp to ensure that neither rain nor snow enters the spa.

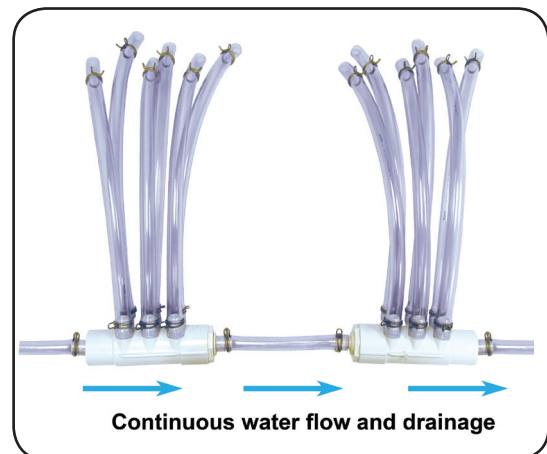

NOTE: All manifolds are plumbed in series directly to the main drain (see example at right), making it easier to remove water and reducing the possibility of freeze damage.

Cleaning and Replacing the Filter

Filtration is one of the most important steps you can take to ensure clean, clear water. It is far less expensive to fix water clarity problems by filtering your spa than by using excessive amounts of chemicals, excessive filtration times, or by water replacement.

See the section "Filter Cleaning" on page 33 for more information.

Vacation Care

You can leave your spa unattended for up to two weeks if you follow these instructions.

ALWAYS lock your cover using the cover locks if you plan to be away from home and the spa is filled with water.

1. Select the Low Range temp choice used for vacation mode. (See instructions on page 20 or page 22 for vacation setting.)
2. Following the water quality instructions starting on page 31, adjust the pH.
3. Shock the water (add either chlorine or bromine sanitizer).
4. When you return, check and adjust the pH and shock the water.

If you will not be using your spa for longer than 14 days and a spa maintenance service is not available, we strongly recommend you drain or winterize your spa.

Cleaning Your Spa

Spa Cover and Pillows

Due to the constant punishment your spa cover and pillows receive, you should protect them by applying a vinyl and leather cleaner as part of your monthly maintenance plan. Use a product that is specifically designed to protect spa covers and pillows from chemical and ultraviolet light damage without leaving an oily residue behind that is normally associated with common automotive vinyl protectants.

Warning: Do not use automotive vinyl protectants on spa covers or pillows. These products are generally oil-based and will cause severe water clarity issues that are difficult to correct.

Spa Shell

Each time you drain your spa, before you refill it you should clean your spa shell with an all-purpose cleaner and apply a coat of surface protectant.

Use a low detergent, non-abrasive cleaner specifically formulated to clean the spa without damaging its acrylic finish.

Use a non-oil based surface protectant that is specifically formulated to protect the spa's finish from the chemicals and minerals associated with normal spa use.

Changing the UV Lamp



CAUTION: Always turn off power to the spa at the GFCI prior to any maintenance.

Note: Periodically you should check the light on the transformer for the UV light system. The transformer is mounted in the spa equipment area in a water resistant enclosure with a door. When it is operating normally, the light will be green. When it requires maintenance, it will be red. This usually happens when the UV lamp needs replacing. The UV lamp is a wearable part that needs replacing about once a year.

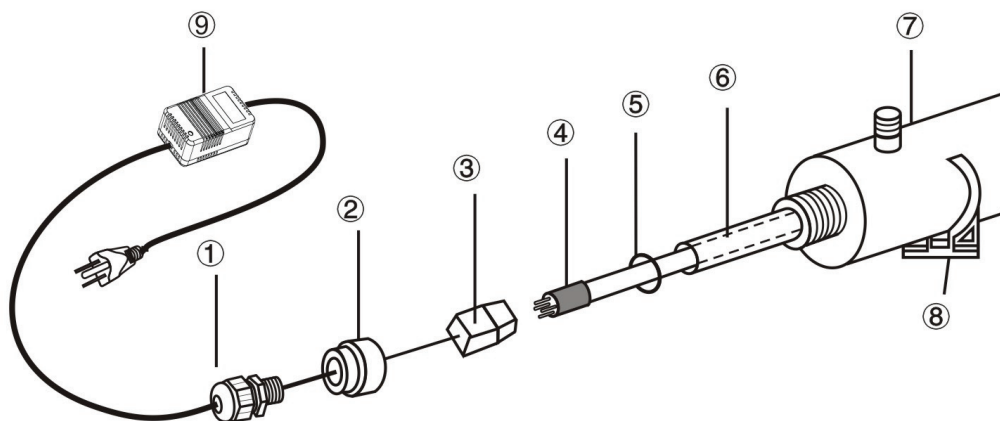

To remove the UV lamp

1. Disconnect power.
2. Turn water off and open down stream of system to relieve pressure.
3. Remove the water-proof strainer (1) and unscrew the aluminum nut (2).
4. Pull out the lamp (4) approximately 2" from the chamber (7).
5. While holding the lamp end, remove the lamp socket (3) from the end now exposed.
6. Remove the lamp from the chamber.
7. Remove the O-ring (5) from the end of the quartz thimble (6).
8. Remove the quartz thimble.

1	Water-proof strainer
2	Aluminum nut
3	Lamp socket and lead wire
4	Germicidal UV lamp
5	Rubber O-ring
6	Quartz thimble
7	Chamber
8	Clip
9	Ballast

See page 47 for part numbers for replacement parts.

To reinstall the replacement UV lamp, follow these steps in reverse.

When replacement UV lamp has been installed, conduct a final leak check:

1. Restore power to the spa at the GFCI.
2. Turn on the pump and let water run for five minutes to check for leaks.

Using the Entertainment System

Some spas may be equipped with an optional entertainment system. Each spa equipped with an audio/visual system is delivered with the manufacturer's operating instructions in a clear plastic bag.

The instructions contained in this manual describe only basic functions. See the manufacturer's operating instructions for other features and functions. We strongly recommend that you read the manufacturer's instructions prior to operating this unit.

Observe the following precautions for your entertainment system:

- Make sure that hands are dry before coming in contact with this or any electronic option.
- Always close the protective door.

Although the marine grade entertainment system is encased in a plastic housing with weather seals, the system is **water resistant** and **NOT waterproof**. You must take every precaution to keep this system dry!

Water damage is not covered by Cal Spas or the manufacturer's warranty.

Aquatic AV AQ-DM-3B Media Locker

The Aquatic AV docking station has very basic features. It will play any audio device with a 3.5mm headphone plug. This device does not use a remote and does not offer Bluetooth connectivity.

The device requires a short connector (NOT PROVIDED) with two 3.5mm connector jacks that attach from your audio device to the inside of the locker.

To open the locker, slide the latch up to unlock the door.

Press the power button inside the locker. The red LED will turn on.

Plug a 3.5mm connector into your audio device and to the inside of the locker.

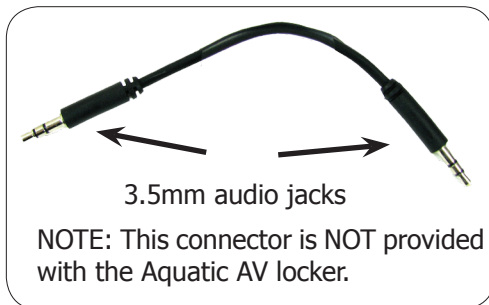

Use the velcro strap to keep your device secure inside the locker while it is in use.

While your audio device is in the locker, close the door and slide the lock to keep it secure and water tight. If this is done properly, it will protect your audio device.

The front panel has basic controls for controlling the audio only. All other functions, such as track selection, must be controlled from your audio device.



Aquavibe MD-350 Docking Station

The Aquavibe docking station can be used with an iPhone, iPad, any device with a 3.5mm audio output (headphone jack), or any Bluetooth capable device. These instructions contain brief descriptions of commonly used features and functions. For more in-depth information on the Aquavibe MD-350, see the user's manual that was included in the docking station.

Pairing the Remote Control

1. Press and hold the MODE button on the remote control until "PAIR" appears in its display.
2. While still holding the MODE button on the remote control, press the RESET button in the interior of the waterproof compartment.
3. If the pairing is successful, the dock will restart and "PAIR" will disappear from the remote's display. Release the MODE button on the remote control.

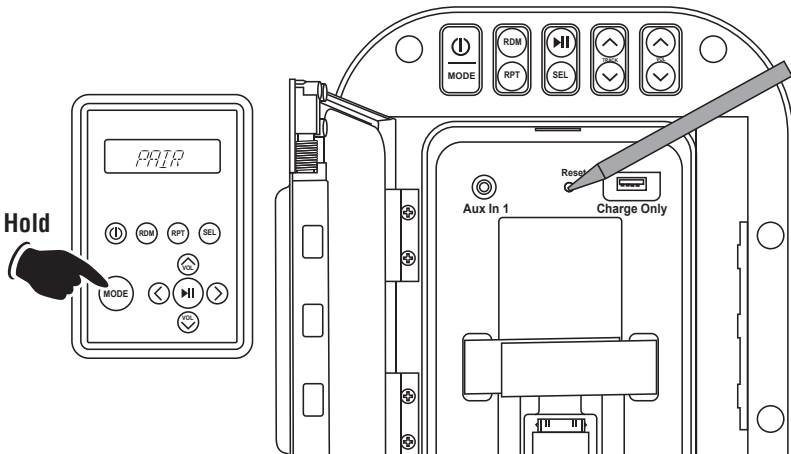

IPHONE or IPOD

1. Open the waterproof door and pull out the 30-pin connector.
2. Plug the connector into the Apple device.
3. Secure the Apple device with the mounting straps.
4. Close the waterproof door.
5. Press the MODE button until "IPOD" appears in the display.
6. Use the controls on the locker door to operate the iPod functions.

The unit will automatically switch to the "IPOD" mode when the IPHONE or IPOD is initially connected to the 30-pin connector.

If your Apple device uses a lightning connector, a lightning adapter will plug into the 30-pin connector and will allow you to operate the device normally.

If you use the USB cable that came with your Apple device and plug it into the Charge Only socket, it will only charge the Apple device. It will not control the device.

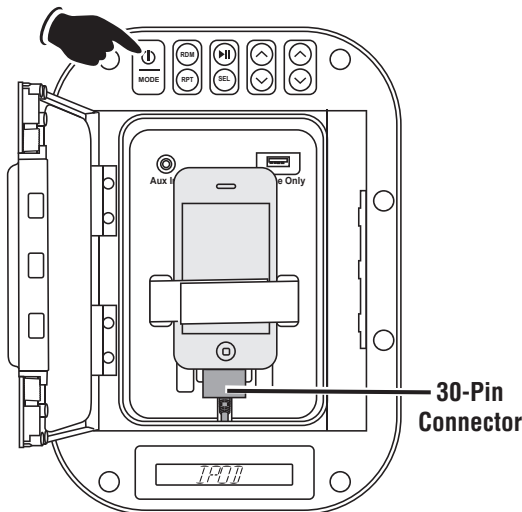

You can also use the Aquavibe remote to operate the Apple device. See remote operation on the next page.

Using a Device with 3.5mm Audio Output

1. Open the waterproof door and plug a 3.5mm cable (not supplied) into the docking station and then into the device.
2. Plug a USB cable (not supplied) into the docking station and then into the device.
3. Secure the device with the mounting straps.
4. Close the waterproof door.
5. Press the MODE button until "AUX IN1" appears in the display.
6. Use the controls on the entertainment center to adjust the volume.

The USB cable does not have to be connected for proper operation. Connecting the USB cable will only charge the device. No data transfer will occur. If cables are not being used, remove the cable from the waterproof compartment. The unit will not automatically switch to "AUX IN1" mode when the device is initially connected to the 3.5mm cable. Select "AUX IN1" using the MODE button. The entertainment center will not control the device. It just allows for the audio from the device to play through the entertainment center.

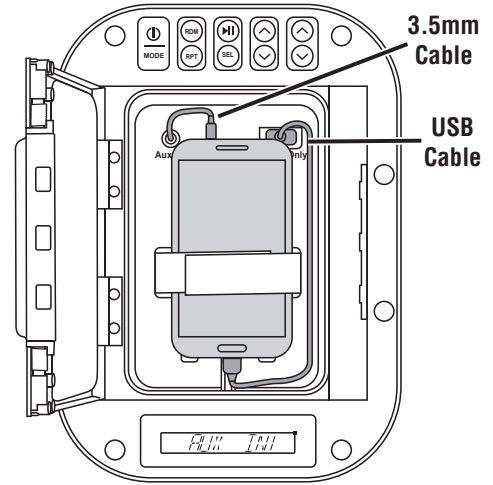



NOTE: These connectors are NOT provided with the Aquavibe locker.



USB cable for your phone or audio player

Pairing Bluetooth Devices

1. Open the Bluetooth setup program on the mobile device and activate the Bluetooth feature.
2. Press the  button to turn on the entertainment center.
3. From your mobile device scan for available devices. Select "AQUAVIBE" to connect to the unit.
4. When the mobile device has been paired  will appear in the entertainment center's display.
5. Press the MODE button until "BT AUDIO" appears in the display. Bluetooth audio from your mobile device can now be played through the entertainment center.

Note 1: A previously paired Bluetooth mobile device will automatically connect to the entertainment center when "BT AUDIO" is selected using the MODE button (if it is within range).

Note 2: If the Bluetooth mobile device is already paired with the entertainment center, select "AQUAVIBE" on your phone and touch "Connect".

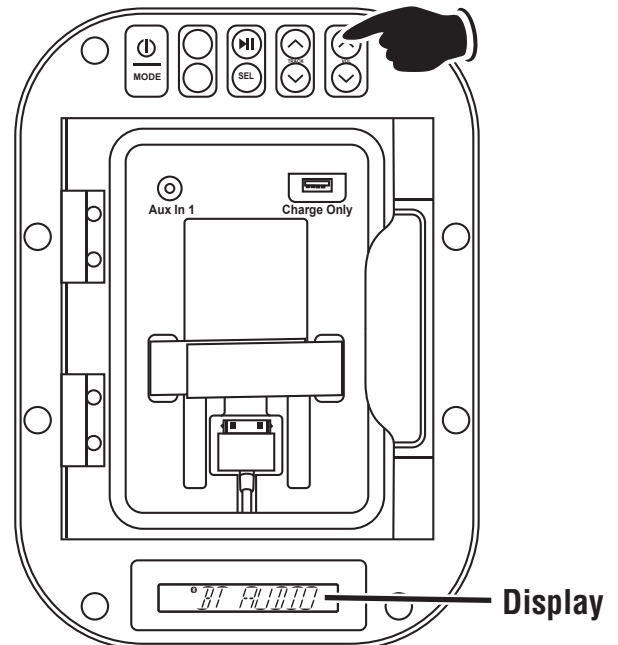

Replacement Parts

Please visit www.quickspaparts.com to order your replacement parts.

Note: All Cal Spa models use screw-in jet inserts where removable jets are used.

Jets

ELE 2" Euro No Eyeball

PLUCS2295021SL



ED 2" Euro Directional

PLUCS2295051SL

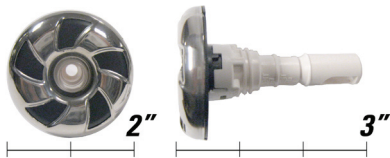

NJS 2" Directional Neck Jet Shower 100% Shut Off #CS2255051SL Candy Cane

PLUCS2255051SL

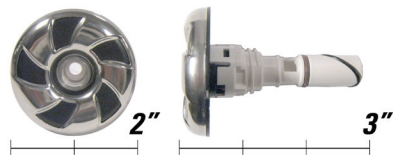

MED 3" XL Cluster Storm Directional

PLUCS2295031SL



MM Mini Storm Massage #CS2297061SL Candy Cane

PLUCS2297061SL

mfd 3" Micro Flow Directional

PLU2295061SL

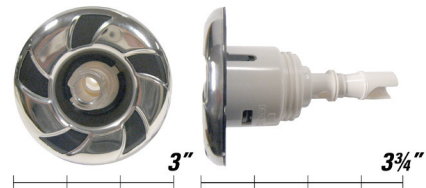

mm Mini Storm Massage

PLUCS2297061SL

MFD 3.5" Maxi Flow Directional

PLU2295091SL

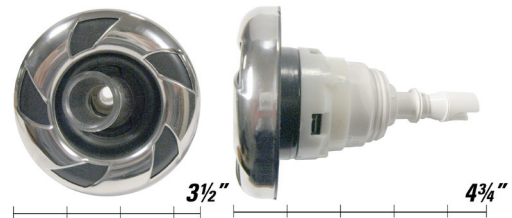

PSD 5" Power Storm

PLUCS2295131SL

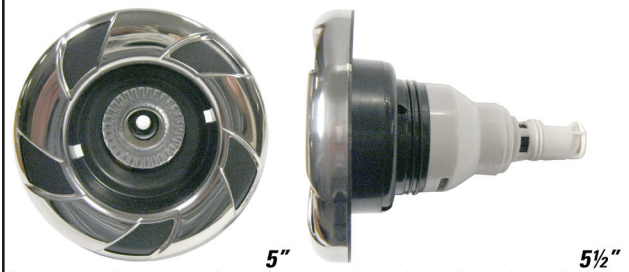



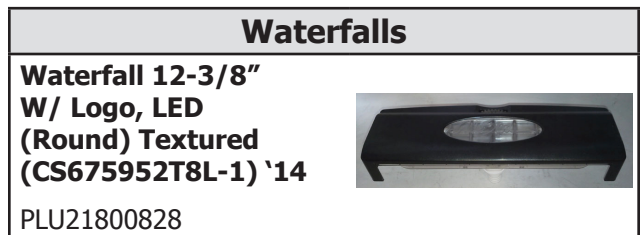
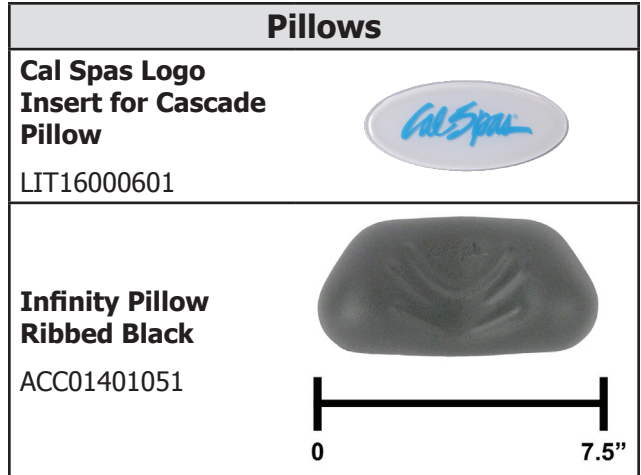

Please visit www.quickspaparts.com to order your replacement parts.

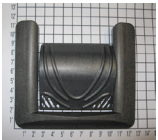

Please visit www.quickspaparts.com to order your replacement parts.

Drains	
Drain Super Hi Flo Suction 2 1/2" Black (640-3581LGV) PLU21400146	
Low Profile Drain 3/4" Black (640-0511) PLU21400401	
Bottom Drain Filtration Return Assembly PLU21400215	

Weir Skimmers	
Weir Skimmer Gate Small Black PLU21600284	
Weir Skimmer Gate Large Black PLU21600294	

Filters		
All filters are anti-bacterial threaded cartridges.		
25 Sq Ft FIL11100303	50 Sq Ft FIL11100202	75 Sq Ft FIL11100212
		

Pure Cure™ UV Water Sanitizer	
Pure Cure complete system LIT16000380	
Germicidal UV lamp (T515) LIT16000381	
Rubber O-ring (D24.5) LIT16000384	
Quartz thimble (24.5X350) LIT16000383	
Ballast (UV-3) LIT16000382	
Clips LIT16000385	

Lights	
Light Assembly Complete LIT16000150	
Light Mini 2" Diameter LIT16000151	

Please visit www.quickspaparts.com to order your replacement parts.

LED Lights	
<p>Small Controller Daisy Chain LIT16100218</p>	
<p>Large Controller LIT16100241</p>	
<p>Quad LED Daisy Chain Assembly LIT16100211</p>	
<p>Dual LED Daisy Chain Assembly LIT16100212</p>	
<p>7 LED 2" Light Daisy Chain with Stand-Off LIT16100214</p>	
<p>LED Light, 12 LED LIT16100206</p>	

Replacement Cabinet Panels

The complete selection of replacement cabinets for all models is very extensive and too lengthy for this owner's manual. To order replacement panels for your spa, visit www.quickspaparts.com.

Covers

All spa covers are designed with a tapered height, angling downward from the center to the sides to drive off rain and prevent water from pooling.

Covers - all sizes except 7 foot and 8 foot spas

The covers listed below are filled with either 1 lb. or 1.5 lb. foam.

Basic

4" - 2.5"
1.0 Lb. foam

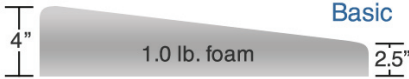

Standard

4" - 2.5"
1.5 Lb. foam



Size	Type	Part numbers	
72" x 72" triangle	Basic	Gray	COV7272TRBAS42G1.0
		Slate	COV7272TRBAS42S1.0
		Black	COV7272TRBAS42B1.0
	Standard	Gray	COV7272TRSTD53G1.5
		Slate	COV7272TRSTD53S1.5
		Black	COV7272TRSTD53B1.5
78" round	Basic	Gray	COV78RDBAS42G1.0
		Slate	COV78RDBAS42S1.0
		Black	COV78RDBAS42B1.0
84" x 84" (7 foot spas)	Basic	Gray	COV8484B42G1.0
		Rust	COV8484B42R1.0
		Slate	COV8484B42S1.0
		Black	COV8484B42BK1.0
	Standard	Gray	COV8484S42G1.0
		Rust	COV8484S42R1.0
		Slate	COV8484S42S1.0
		Black	COV8484S42BK1.0
	Deluxe	Gray	COV8484D42G1.0
Rust		COV8484D42R1.0	
Slate		COV8484D42S1.0	
Black		COV8484D42BK1.0	

Please visit www.quickspaparts.com
to order your replacement parts.

Size	Type	Part numbers	
93" X 93" (8 foot spas)	Basic	Gray	COV9393B42G1.0
		Rust	COV9393B42R1.0
		Slate	COV9393B42S1.0
		Black	COV9393B42BK1.0
	Standard	Gray	COV9393S42G1.0
		Rust	COV9393S42R1.0
		Slate	COV9393S42S1.0
		Black	COV9393S42BK1.0
	Deluxe	Gray	COV9393D42G1.0
		Rust	COV9393D42R1.0
		Slate	COV9393D42S1.0
		Black	COV9393D42BK1.0

Basic Troubleshooting

The troubleshooting guidance provided here is intended to cover the most common problems a spa owner may encounter. For more in-depth troubleshooting, go to www.calspas.com/troubleshooting.

Symptom	Possible Solutions
---------	--------------------

Problems starting up

Pump won't prime	See priming instructions on page 11.
Breaker keeps shutting off	Reset the GFCI breaker. If this continues, contact your dealer or a qualified spa technician.

Power and system problems

System won't start up or breaker keeps shutting off	Power may be shut off. Turn on GFCI circuit breaker. If this continues, contact your dealer or a qualified spa technician.
Control panel doesn't respond	Turn on or reset the GFCI circuit breaker. If this does not solve the problem, contact your dealer or a qualified spa technician. If you hear the pump running but the control panel doesn't respond, contact your dealer
Spa does not turn off	Spa may be trying to heat up. Check if spa is in Ready or Rest mode (see page 21 or page 22) In cold climates, if spa is not equipped with full foam or any kind of insulation, it will try to maintain the set temperature. Set the spa to low temperature range and set the temperature to 80°F. Spa may be in filter cycle. If it is, this is normal and no adjustment is necessary.
Message on the control panel	There may be a problem. See Diagnostic Messages on page 25 or page 24.

Heat problems

Spa water does not get hot	Spa may be in low temperature range. Set the spa to high temperature range. The filter may be dirty or may need to be replaced. Clean or replace the filter. The water level may be too low. Fill the spa with water level at 4 to 6 inches from the top. The temperature is not turned up high enough. Raise temperature on topside control. Cover the spa. The cover will keep heat in the spa and help keep heat from escaping. Make sure cover is on at all times when spa is not in use. The heater element may be old, deteriorated, coated with scale, or defective. Contact your dealer for more assistance. The gate valves may be partially or completely closed. NEVER OPERATE YOUR SPA WITH THE GATE VALVES CLOSED!
Spa overheats - temperature greater than 110°F / 43°C	Overheating can occur during summer months and may not necessarily indicate a malfunction. When it occurs, a message code may also appear on the control panel. Temperature may be set too high. Turn the set temperature down to a lower temperature. Filtration time may be too long. Turn the filtration cycles down during the warm months. The spa may not be properly ventilated. Make sure the front of the spa is not blocked to allow air flow. High speed pumps may have been running too long. Limit pump running time to no more than 15 to 30 minutes.

Symptom	Possible Solutions
Water pressure problems	
Low water pressure	<p>Jet valves may be partially or fully closed. Open the jet valves.</p> <p>Filter cartridge may be dirty. Clean or replace the filter.</p> <p>Pump may have airlock. Remove airlock by priming spa (page 11)</p> <p>The suction fittings may be blocked. Remove any debris that may be blocking them.</p> <p>The filter skimmer may be blocked. Remove the blockage.</p> <p>Gate valves may be closed. Open gate valves. Note: Never operate your spa with the gate valves closed!</p> <p>Spa may be running in filtration mode. Press JETS or JETS 1 button to turn on high speed pump.</p>
No water pressure (no water stream from any jets)	<p>Power may be switched off. Turn the power back on.</p> <p>The pump may be defective. After you have tried all other troubleshooting, contact your dealer for assistance.</p>
Jets surge on and off	Water level may be too low. Add water to normal level.
Pump problems	
Pump runs constantly – will not shut off	There may be a problem with circuit board. Contact your dealer.
Noisy pump	<p>The water level may be too low. Fill the spa with water level at 4 to 6 inches from the top.</p> <p>Filter cartridge may be dirty. Clean or replace the filter.</p> <p>Pump may have airlock. Remove airlock by priming spa (page 11)</p> <p>The suction fittings may be blocked. Remove any debris that may be blocking the suction fittings.</p> <p>Gate valves may be closed. Open gate valves. Note: Never operate your spa with the gate valves closed!</p> <p>Air may be leaking into the suction line. Contact your dealer for assistance.</p> <p>Debris may be inside the pump. Contact your dealer for assistance.</p> <p>Noise may be a sign of damage. Contact your dealer for service.</p>
Pump turns off during operation	<p>Automatic timer may have completed its cycle. Press JETS or JETS 1 button to start the cycle again.</p> <p>Pump may have overheated due to the vents on the equipment door being blocked. Make sure the front of the spa is not blocked to allow air flow.</p> <p>The pump motor may be defective. Contact your dealer for assistance.</p>
Pump has a burning smell while running	A burning smell may be a sign of damage. Contact your dealer for service.
Pump does not run	<p>Pump may have over heated. Let it cool for an hour and try operating the spa for a shorter time.</p> <p>Power to the spa may be shut off. Turn on or reset the GFCI circuit breaker. If this does not solve the problem, contact your dealer or a qualified spa technician.</p>

LIMITED WARRANTY

This Limited Warranty is extended to the original purchaser of a Cal Spa brand portable spa manufactured after January 1, 2014 for Secard Spas and installed for residential use in the United States of America and Canada. This warranty begins on the date of delivery of the spa, but in no event later than one year from the date of manufacture.

	Aqua series models	LES and GII series models
Shell Structural Warranted against water loss due to defects in the spa shell.	2 years	5 years
Shell Finish Warranted against blistering, cracking, or delaminating of the interior surface of the spa shell.	2 years	2 years
Equipment and Controls Electrical equipment components – specifically limited to the pumps, heater, and control system – are warranted against malfunctions due to defects in workmanship or materials.	2 years	2 years
Plumbing Warranted against leaks due to defects in workmanship or materials.	2 years	2 years
Cabinet - synthetic, fiberglass, or wicker Warranted against defects in workmanship or materials. Normal wear and weathering of the finish will occur naturally over time and are not defects.	2 years	1 year
Labor Covers cost of service and repair while spa is under warranty.	2 years	2 years

Warranties for Other Components

The fuses, headrests, cabinet finish, and filters are warranted to be free of defects in workmanship and material at the time of delivery. The factory installed Pure Cure water purification system is warranted against malfunction due to defects in workmanship or material for one year from the original date of delivery except the UV bulb and quartz tube. The UV bulb and quartz tube are warranted for ninety (90) days from the original date of the spa delivery. All stereo-related components (receiver, speakers, sub-woofer, stereo media locker, power supply, wireless remote control etc.) are warranted against malfunction due to defects in workmanship or material for one year from the original date of delivery. All other factory-installed components not mentioned specifically, including, but not limited to the wood frame, jets, diverter valves, LED lighting systems, filter lids, and mechanical

components, are warranted against malfunction due to defects in workmanship and material for two years from the original date of delivery.

Genuine Cal Spas Parts & Accessories

This Limited Warranty is void if Cal Spas (the "Manufacturer") or its designated representative determines that the spa has been subjected to damage or failure due to installation of aftermarket parts that are not genuine Cal Spas branded parts and accessories. This disclaimer includes, but is not limited to filters, UV bulbs, ozone systems, salt systems, repair parts and other accessories. Genuine Cal Spas brand parts and accessories are built to our highest standards of quality, durability and performance, and they are designed to work with your Spa to ensure optimal performance and function.

Performance

This warranty begins on the date of delivery of the spa, but in no event later than one year from the date of manufacture.

To obtain service in the event of a defect covered by this Limited Warranty, notify your Cal Spa dealer or Cal Spas (the "Manufacturer") as soon as possible and use all reasonable means to protect the spa from further damage. Upon proof of purchase, a designated service representative will correct the defect subject to the terms and conditions contained in this Limited Warranty. There will be no charge for parts or labor to repair the defect, although providing access to affect the repair is your responsibility as the spa owner. Freight charges for replacement parts is the responsibility of the spa owner. You may be assessed reasonable repairman travel mileage charges.

In the event that the spa is removed to a repair facility for repair and reinstalled, the cost of removal and reinstallation will be your responsibility as the spa owner. If the Manufacturer determines that repair of the covered defect is not feasible, it reserves the right to provide a replacement spa instead, equal in value to the purchase price of the original spa. In such an event, reasonable costs for removal of the original spa, shipping costs from the factory for the replacement spa and delivery and installation of the replacement will be your responsibility as the spa owner. The replacement spa will carry the balance of the original spa's warranty. Spa covers are not included.

This warranty ends either by specified time frame, owner-transfer, relocation, or installation of any component other than by manufacturer.

Warranty Limitations

This Limited Warranty is void if Cal Spas (the "Manufacturer") or its designated representative determines that the spa has been subjected to alteration, neglect, misuse or abuse, or freight damage caused by the common carrier; any repairs have been attempted by anyone other than a designated representative; the failure is caused by accident, acts of God or other causes beyond the control of the Manufacturer; neglect, misuse and abuse include any installation, operation or maintenance of the spa other than in accordance with the instructions contained in the owner's manual provided with the spa, including but not limited to the failure to maintain proper water chemistry and chemical balance and the use of abrasive or improper cleaners or non-genuine parts and accessories. This Limited Warranty does not provide coverage for the insulating cover, any item

attached to or installed on the spa after the date of manufacture, or for gaining access to any component for repair or replacement. Spa units in commercial use are excluded from any coverage whatsoever. The spa owner accepts liability for repair work performed by anyone other than the Manufacturer or a designated Cal Spa representative.

Limitations

The Manufacturer disclaims all warranties, expressed or implied, in fact or in law, to the extent allowed by your State's Law, including the warranty of merchantability and fitness for use, except as stated specifically herein. All warranty service must be performed by the Manufacturer or its designated representative using authorized Cal Spa parts. No agent, dealer, distributor, service company or other party is authorized to change, modify or extend the terms of this limited warranty in any manner whatsoever. The Manufacturer will not be responsible for any statements or representations made in any form that go beyond, are broader than, or are inconsistent with any authorized literature or specifications furnished by Cal Spas.

Disclaimers

The Manufacturer and its representatives shall not be liable for any injury, loss, cost or other damage, whether incidental or consequential, arising out of any defect covered by this limited warranty, including without limitation, loss of use of the spa and cost for removal of defective product even if the Manufacturer was advised of the possibility of damage. The liability of the Manufacturer under this limited warranty, if any, shall not exceed the original amount paid for the defective product. Coverage under this limited warranty shall commence as of the original date of delivery and the duration of such coverage shall not extend for any reason whatsoever beyond the stated time periods. These disclaimers shall be equally applicable to any service provided by the Manufacturer and its designated representatives.

Legal Rights

This Limited Warranty gives you specific legal rights. You may also have other rights that vary from state to state. Some states do not allow limitations on how long an implied warranty lasts, so this limitation may not apply to you.

Warranty Registration

Easy Online Registration

Registering your new Cal Spas product is quick and easy! It is important that you register your Cal Spas product as soon as possible. By taking just a few quick minutes to register, you can enjoy product alerts, more efficient support, and quicker service.

Register now -- it's fast and it's easy!

- 1) Go to www.calspas.com/warranty
- 2) Fill in your information and click "Send Warranty Info"

Locating the product serial number

The serial number of your spa is located on a metal plate attached to the inside of the door for the equipment area. You will need this number to properly register your spa and activate coverage. Write this information in the space provided below.

Spa Model: _____

Spa Serial Number: _____

Date Purchased: _____

Date Installed: _____

Dealer's Phone Number: _____

Dealer's Address: _____



Please visit www.quickspaparts.com
to order your replacement parts.