

Cal Spas®

# OWNER'S MANUAL

Swim-Pro Spas

2017



United States, Canada



2631-16-G

[www.calspas.com](http://www.calspas.com)

# Table of Contents

## Preparing for Your New Portable Spa

Pre-Delivery Checklist . . . . .	2
Planning the Best Location . . . . .	2
Preparing a Good Foundation . . . . .	3
240 Volt Electrical Installation . . . . .	3
GFCI Wiring Diagrams . . . . .	5
Filling and Powering Up Your Portable Spa	8
Priming the Pump . . . . .	10

## Operating Your Spa

TP400 and TP600 Control Panel Operation	12
TP800 Control Panel Operation . . . . .	20
spaTouch Icon Driven Control Panel . . . . .	25
Cal Spas Hot Tub Wi-Fi App . . . . .	33
Cloud Service . . . . .	34
Electrical Power Efficiency . . . . .	35
Jets . . . . .	35
LED Lighting . . . . .	36
Diverter Knobs . . . . .	36
Waterfalls . . . . .	36
Air Venturis . . . . .	36
Hydro Streamer Waterfall . . . . .	36

## Water Clarity

The Key to Clear Water . . . . .	37
Testing and Adjusting Spa Water . . . . .	37
Sanitation . . . . .	38
Bather Load . . . . .	39
Filter Cleaning . . . . .	39
Pure Cure™ Water Sanitizer . . . . .	40
Ozonator . . . . .	40
Maintenance Schedule . . . . .	40
Troubleshooting Water Clarity Problems . .	41

## Cleaning and Maintenance

Removing and Reseating the Pillows . . . . .	42
Jet Remove/Replace . . . . .	42
Spa Cover . . . . .	42
Draining Your Portable Spa . . . . .	43
Winterizing (Cold Climate Draining) . . . . .	44
Cleaning and Replacing the Filter . . . . .	44
Vacation Care . . . . .	44
Cleaning Your Spa . . . . .	45
Changing the UV Lamp . . . . .	45
Aquatic AV AQ-DM-5UBT Media Locker . . .	46

## Using the Digital Media Locker

Using the Freedom Sound System . . . . .	48
Remote and Keypad Functions . . . . .	48
Closing and Locking the Door . . . . .	48

## Keeping Fit With Your Swim Spa

Jetstream Propulsion System . . . . .	49
Swim Tether . . . . .	49
Exercise Equipment . . . . .	49

## Appendix

Replacement Parts . . . . .	51
Basic Troubleshooting . . . . .	54
Limited Warranty . . . . .	56

Copyright 2017 LMS. All rights reserved. Duplication without written consent is strictly prohibited.

Cal Spas®, Adjustable Therapy System™, ATS™, Cal Premium™, Cal Select™, Cal Stone™, Pure Cure™, XL™ Heater, and Ultimate Fitness Spa Series™ are registered trademarks.

Due to continuous improvement programs, all models, operation, and/or specifications are subject to change without prior notice.

LTR20171005, Rev. F  
10/9/17

100-1394

### CONTACT INFORMATION

For customer service, please contact your authorized dealer immediately. If you need additional information and/or assistance, contact:

**LMS Customer Service Department**  
**1462 East Ninth Street**  
**Pomona, CA 91766.**

Toll Free: 1-800-CAL-SPAS  
Fax: 1-909-629-3890

# Important Safety Instructions

## READ AND FOLLOW ALL INSTRUCTIONS.

### **DANGER -- Risk of accidental drowning:**

Do not allow children to be in or around a spa unless a responsible adult supervises them. Keep the spa cover on and locked when not in use. See instructions enclosed with your cover for locking procedures.

### **DANGER -- Risk of injury:**

The suction fittings in this spa are sized to match the specific water flow created by the pump. Should the need arise to replace the suction fittings, or the pump, be sure the flow rates are compatible.

Never operate the spa if the suction fitting or filter baskets are broken or missing. Never replace a suction fitting with one that is rated less than the flow rate marked on the original suction fitting.

### **DANGER -- Risk of electric shock:**

Install the spa at least 5 feet (1.5 meters) from all metal surfaces. As an alternative, a spa may be installed within 5 feet of metal surfaces if each metal surface is permanently bonded by a minimum #8 AWG solid copper conductor to the outside of the spa's control box.

Do not permit any external electrical appliances, such as lights, telephones, radios, televisions, and etc., within five feet (1.5 meters) of the spa. Never attempt to operate any electrical device from inside the spa.

Replace a damaged power cord immediately.

Do not bury the power cord.

Connect to a grounded, grounding-type receptacle only.

### **WARNING -- To reduce the risk of injury:**

The spa water should never exceed 104°F (40°C). Water temperatures between 100°F (38°C) and 104°F (40°C) are considered safe for a healthy adult. Lower water temperatures are recommended for young children and when spa use exceeds 10 minutes.

High water temperatures have a high potential for causing fetal damage during pregnancy. Women who are pregnant, or who think they are pregnant, should always check with their physician prior to spa usage.

The use of alcohol, drugs or medication before or

during spa use may lead to unconsciousness, with the possibility of drowning.

Persons suffering from obesity, a medical history of heart disease, low or high blood pressure, circulatory system problems or diabetes should consult a physician before using the spa.

Persons using medications should consult a physician before using the spa since some medications may induce drowsiness while others may affect heart rate, blood pressure and circulation.

### **HYPERTHERMIA DANGER:**

Prolonged exposure to hot air or water can induce hyperthermia. Hyperthermia occurs when the internal temperature of the body reaches a level 3°F to 6°F above the normal body temperature of 98.6°F (or 2°C to 4°C above 37°C). While hyperthermia has many health benefits, it is important not to allow your body's core temperature to rise above 103°F (39.5°C). Symptoms of excessive hyperthermia include dizziness, lethargy, drowsiness and fainting. The effects of excessive hyperthermia may include:

- Failure to perceive heat
- Failure to recognize the need to exit spa or hot tub
- Unawareness of impending hazard
- Fetal damage in pregnant women
- Physical inability to exit the spa
- Unconsciousness

**WARNING:** The use of alcohol, drugs, or medication can

greatly increase the risk of fatal hyperthermia.

**WARNING:** People with infectious diseases should not use a spa or hot tub.

**WARNING:** To avoid injury, exercise care when entering or exiting the spa or hot tub.

**WARNING:** Do not use drugs or alcohol before or during the use of a spa or hot tub to avoid unconsciousness and possible drowning.

**WARNING:** Do not use a spa or hot tub immediately following strenuous exercise.

**WARNING:** Prolonged immersion in a spa or hot tub may be injurious to your health.

**CAUTION:** Maintain water chemistry in accordance with manufacturer's instructions.

**SAVE THESE INSTRUCTIONS.**

# Preparing for Your New Portable Spa

## Pre-Delivery Checklist

Most cities and counties require permits for exterior construction and electrical circuits. In addition, some communities have codes requiring residential barriers such as fencing and/or self-closing gates on property to prevent unsupervised access to the property by children. Your dealer can provide information on which permits may be required and how to obtain them prior to the delivery of your spa.

Before Delivery	
	Plan your delivery route
	Choose a suitable location for the spa
	Lay a 5 - 8 cm concrete slab
	Install dedicated electrical supply
After Delivery	
	Place spa on slab
	Connect electrical components

## Planning the Best Location

### Safety First

Do not place your spa within 10 feet (3 m) of overhead power lines.

### Consider How You Will Use Your Spa

How you intend to use your spa will help you determine where you should position it. For example, will you use your spa for recreational or therapeutic purposes? If your spa is mainly used for family recreation, be sure to leave plenty of room around it for activity. If you will use it for relaxation and therapy, you will probably want to create a specific mood around it.

### Plan for Your Environment

If you live in a region where it snows in the winter or rains frequently, place the spa near a house entry. By doing this, you will have a place to change clothes and not be uncomfortable.

### Consider Your Privacy

In a cold-weather climate, bare trees won't provide much privacy. Think of your spa's surroundings during all seasons to determine your best privacy options. Consider the view of your neighbors as well when you plan the location of your spa.

### Provide a View with Your Spa

Think about the direction you will be facing when sitting in your spa. Do you have a special landscaped area in your yard that you find enjoyable? Perhaps there is an area that catches a soothing breeze during the day or a lovely sunset in the evening.

### Keep Your Spa Clean

In planning your spa's location, consider a location where the path to and from the house can be kept clean and free of debris.

Prevent dirt and contaminants from being tracked into your spa by placing a foot mat at the spa's entrance where the bathers can clean their feet before entering your spa.

### Allow for Service Access

Make sure the spa is positioned so that access to the equipment compartment and all side panels will not be blocked.

Many people choose to install a decorative structure around their spa. If you are installing your spa with any type of structure on the outside, such as a gazebo, remember to allow access for service. It is always best to design special installations so that the spa can still be moved, or lifted off the ground.

## Preparing a Good Foundation

Your spa needs a solid and level foundation. The area that it sits on must be able to support the weight of the spa, with water and the occupants who use it. If the foundation is inadequate, it may shift or settle after the spa is in place, causing stress that could DAMAGE YOUR SPA SHELL AND FINISH.

**Damage caused by inadequate or improper foundation support is not covered by the warranty. It is the responsibility of the spa owner to provide a proper foundation for the spa.**

Place the spa on an elevated 3 to 4" / 30 cm concrete slab. Pavers, gravel, brick, sand, timbers or dirt foundations are **not** adequate to support the spa.

We strongly recommend that a qualified, licensed contractor prepare the foundation for your spa.

If you are installing the spa indoors, pay close attention to the flooring beneath it. Choose flooring that will not be damaged or stained.

If you are installing your spa on an elevated wood deck or other structure, it is highly recommended that you consult a structural engineer or contractor to ensure the structure will support the weight of 150 pounds per square foot (732 kg / m<sup>2</sup>).

To properly identify the weight of your new spa when full, remember water weighs 8.33 lbs. per gallon, or 1 kg per liter. For example, an average 8' spa holds approximately 500 gallons, or 1892 liters, of water. Using this formula, you will find that the weight of the water alone is 4,165 lbs, or 1892 kg. Combined with the dry weight of the spa you will note that this spa will weigh approximately 5,000 lbs, or 2267 kg, when full of water.



## 240 Volt Electrical Installation

All 240V spas must be permanently connected (hard wired) to the power supply. See the GFCI and wiring requirements on page 5.

**These instructions describe the only acceptable electrical wiring procedure. Spas wired in any other way will void your warranty and may result in serious injury.**

When installed in the United States, the electrical wiring of this spa must meet the requirements of NEC 70 and any applicable local, state, and federal codes.

**The electrical circuit must be installed by an electrical contractor and approved by a local building or electrical inspector.**

**Failure to comply with state and local codes**

**may result in fire or personal injury and will be the sole responsibility of the spa owner.**

The power supplied to the spa must be on a dedicated GFCI protected circuit as required by NEC 70 with no other appliances or lights sharing the power.

Use copper wire with THHN insulation. Do not use aluminum wire.

Use the table below and on the next page to determine your GFCI and wiring requirements.

Wires that run over 100 feet must increase wire gauge to the next lower number. For example: A normal 50 amp GFCI with four #6 AWG copper wires that run over 100 feet would require you to go to four #4 AWG copper wires.

## GFCI and Wiring Requirements

**Applies to all fitness spas except F-1781**

### Standard configuration with one 5.5 kW heater

Spa Model	Control System	GFCI Required	Wires Required	Wiring Diagram
F-1222	BP501G1	One 50 amp GFCI	Four #6 AWG copper wires	Use wiring diagram 1 (see page 5)
F-1325	BP501G1	One 50 amp GFCI		
F-1420	BP501G1	One 50 amp GFCI		
F-1437	BP501X	One 50 amp GFCI		
F-1641	BP20X	One 60 amp GFCI		
F-1681	BP20X	One 60 amp GFCI		

### Configuration for Option OPT17-200 (auxiliary 5.5 kW heater)

Spa Model	Control System	GFCI Required	Wires Required	Wiring Diagram
F-1437	BP501X	One 50 amp GFCI	Four #6 AWG copper wires	Use wiring diagram 2 (see page 6)
F-1641	BP20X	One 60 amp GFCI and one 30 amp GFCI	Four #6 AWG copper wires	Use wiring diagram 2 (see page 6)

**Applies to model F-1781 only**

### Standard configuration with one 5.5 kW heater

Control System	Spa Side	GFCI Required	Wires Required	Wiring Diagram
BP501G1	Service (spa side)	One 40 amp GFCI	Four #8 AWG copper wires	Use wiring diagram 2 (see page 6)

### Configuration for Option OPT17-200 (auxiliary 5.5 kW heater)

Control System	Spa Side	GFCI Required	Wires Required	Wiring Diagram
BP20X	Service 1 (swim side)	One 60 amp GFCI	Four #6 AWG copper wires	Use wiring diagram 3 (see page 7)
	Service 2 (swim side)	One 30 amp GFCI	Three #8 AWG copper wires	

# GFCI Wiring Diagrams

## Diagram 1

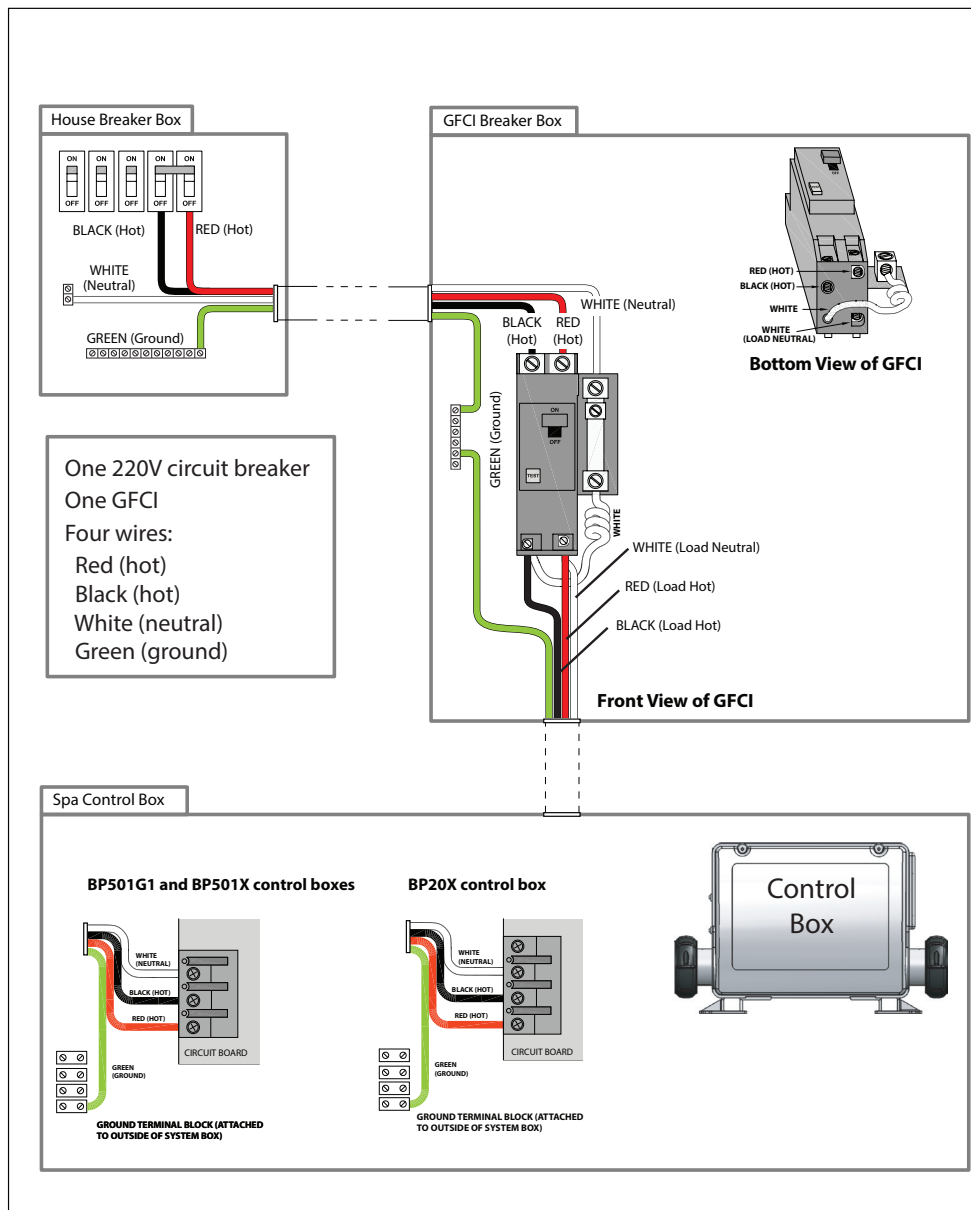

See the Cal Spas Pre-Delivery Guide for more information on spa placement for service access and electrical service.

[www.calspas.com/manuals](http://www.calspas.com/manuals)

Diagram 2

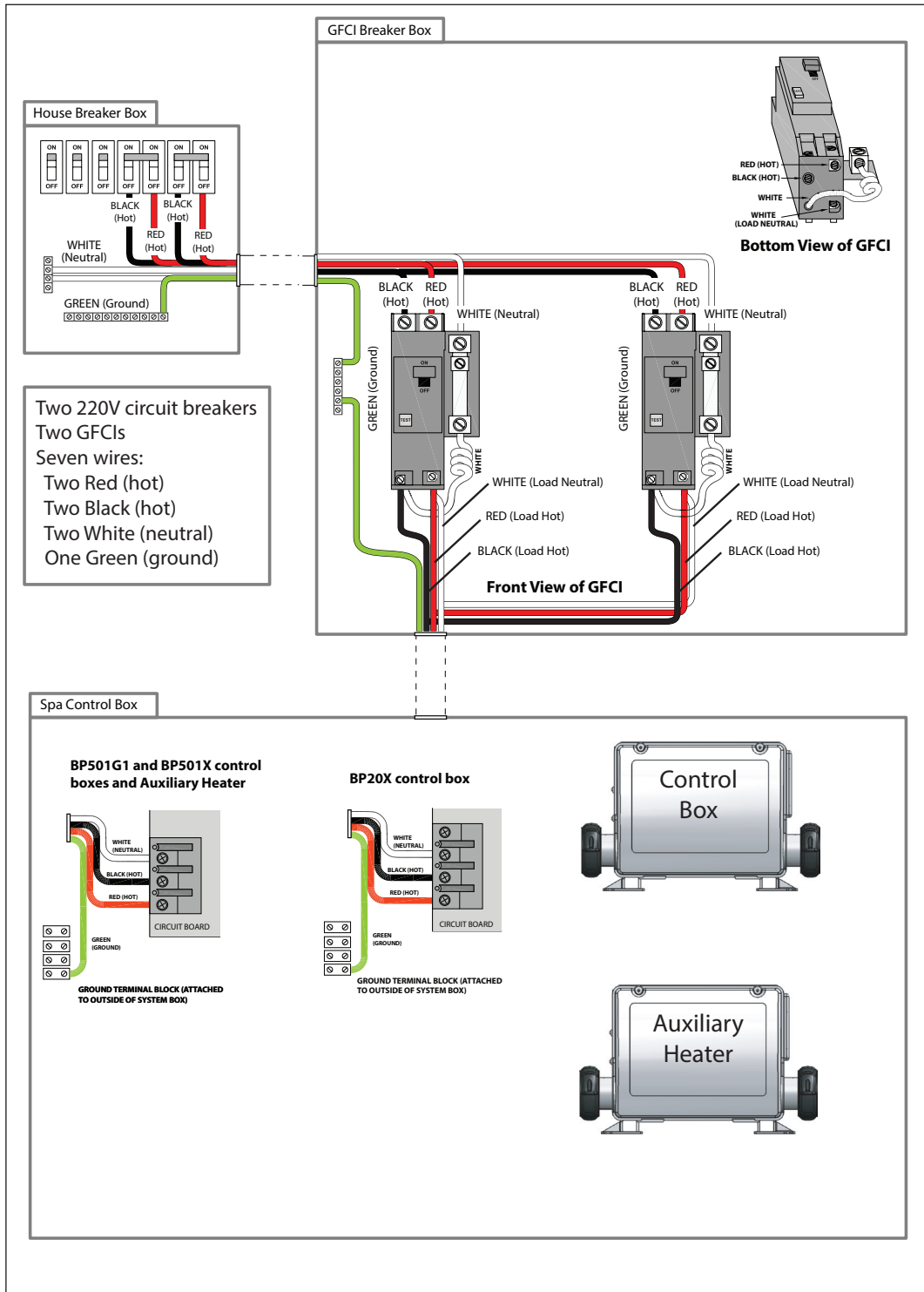



### Diagram 3

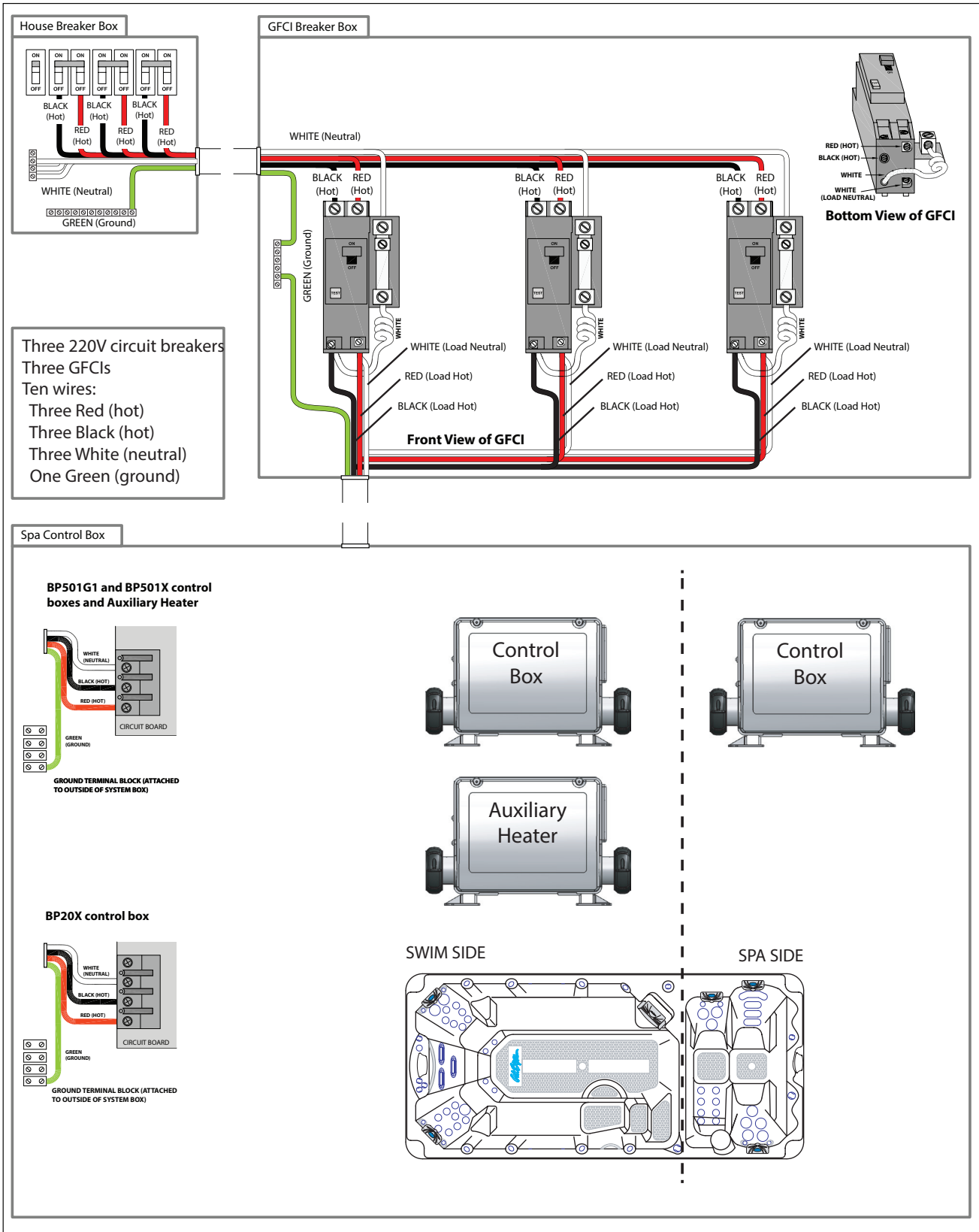

# Filling and Powering Up Your Portable Spa

## 1. Inspect the spa equipment.

Inspect all plumbing connections in the equipment area of your spa.

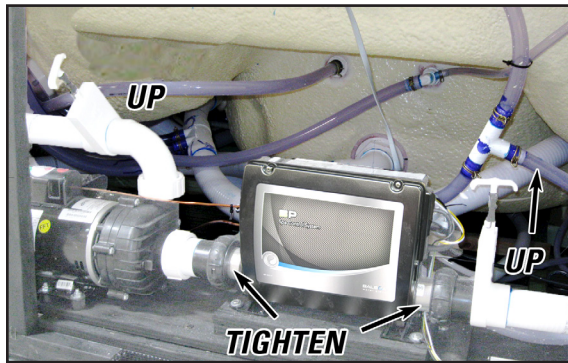

- Make sure unions in the equipment pack are tight. (Be careful not to over-tighten the plumbing fittings.)
- If your spa has gate valves, make sure they are all in the UP or OPEN position.
- Make sure the drain valve is closed and capped. (See page 43 for a description of drain valves.)

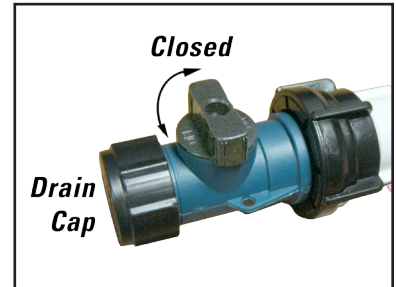

**!** Never run the spa with the gate valves closed or without water circulating for long periods of time.

## 2. Remove the cartridge from filter canister.



Unscrew the cartridge and remove it.

**!** After you remove the filter, remove the plastic wrapper and soak it in water for 30 minutes before you replace it. A dry filter can allow air into the filtration system which can cause the pump to fail to prime.

## 3. Fill the spa.

Place a garden hose in the filter canister and fill your spa with **regular tap water** about six inches from the top.

If the water level is too low or too high, your spa will not operate properly.

**!** Always fill the spa through the filter canister! Failure to do so may cause air to be trapped in the filtration system and prevent the pumps from operating properly.

**!** **Never fill your spa with soft water.**

Soft water makes it impossible to maintain the proper water chemistry and may cause the water to foam, which will ultimately harm the finish of the spa and void your warranty.

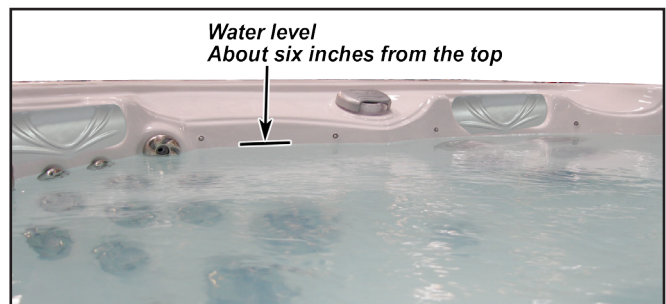

#### 4. Turn on power to the spa.



When the spa is filled to the correct level, turn on the power at the GFCI breaker. (Ensure that the 120V spas are connected to the proper electrical outlet.)

#### 5. Prime the pump.



Your spa will perform a self-diagnostic check and go into Priming Mode. The control panel will display either **RUN PUMPS PURG AIR ---** or **Priming Mode**, depending on which control panel you have.

Do the following:

1. Press the JETS or JETS 1 button once to start the pump in low speed.
2. Press it again to switch the pump to high speed.
3. If you have other pumps, press JETS 2 or JETS 3 to turn them on also.

Running the pumps helps the pumps prime.

After two minutes, the pump should prime. If it does not, follow the priming instructions on the next page. If it does, continue with the next step.

#### 6. Install the filter into the filter canister.



Make sure the filter has soaked at least 30 minutes before you install it.

#### 7. Adjust water chemistry.

Test and adjust the water chemistry. See the section on page 37 for instructions on water clarity.

#### 8. Let the spa heat up.

When the spa has finished priming, the heater will activate. Put the cover on and let the spa heat to the set temperature.

## Priming the Pump

New spa owners often have difficulty the first time they start their spa and the pump fails to prime. This can be frustrating, but these simple instructions can help you.

Sometimes air can become trapped in the pump while filling the spa. You will know this has happened when after you have filled and started the spa, the pump does not seem to function. You will hear the pump operating, but no water will be moving.



The pump will not work properly while air is trapped in it. Continuing to operate the pump in this way will cause damage.

### Starting Up: Priming Mode

After the initial start-up sequence, the spa will enter Priming Mode, which lasts 4 to 5 minutes. Depending on your control panel, one of the messages shown at right will appear.

As soon as the Priming Mode screen appears on the panel, press the Jets or Jets 1 button once to start Pump 1 in low speed and then again to switch to high speed. Also, select the other pumps, to turn them on. The pumps should be running in high speed to facilitate priming.

If the pumps have not primed after two minutes, and water is not flowing from the jets in the spa, do not allow the pumps to continue to run. Turn off the pumps and repeat the process. Note: Turning the power off and back on again will initiate a new pump priming session.

Sometimes momentarily turning the pump off and on will help it to prime. Do not do this more than five times. If the pumps will not prime, shut off the power to the spa and call for service.

**Important:** A pump should not be allowed to run without priming for more than two minutes. Under NO circumstances should a pump be allowed to run without priming beyond the end of the 4 to 5 minute priming mode. Doing so may cause damage to the pump and cause the system to energize the heater and go into an overheat condition.

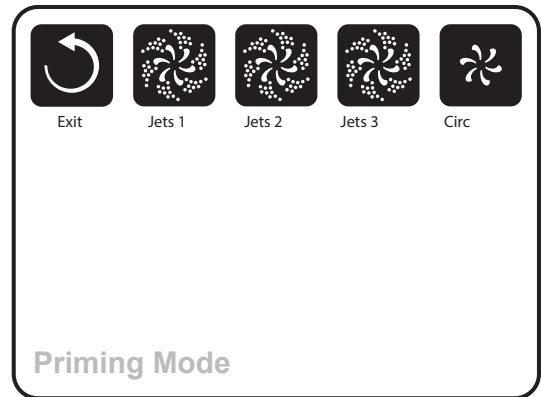

### Exiting Priming Mode

You can manually exit Priming Mode by pressing an Up or Down button. Note that if you do not manually exit the priming mode as described above, the priming mode will be automatically terminated after 4 to 5 minutes. Be sure that the pumps have been primed by this time.

Once the system has exited Priming Mode, the top-side panel will momentarily display the set temperature but the display will not show the temperature yet. This is because the system requires approximately one minute of water flowing through the heater to determine the water temperature and display it.

## Bleeding Air from the Pump

If you have tried priming the pump several times unsuccessfully using the control panel, you can bleed the air from the pump manually.

1. Shut off the power to the spa.
2. Using a Phillips screwdriver, remove the front panel from the spa and locate the pump.
3. Close the gate valve on the discharge side of the pump (if your spa is installed with one.)
4. Turn the bleeder valve counter clockwise with a small pair of pliers until the air has been released from the pump.
5. If this is unsuccessful, loosen the union nut on side of the pump with channel locks. When air is bled out, tighten the nut.
6. Turn on power to the spa and press the JETS button. If there is still air trapped in the pump, repeat steps 2 through 5 until the pump primes.

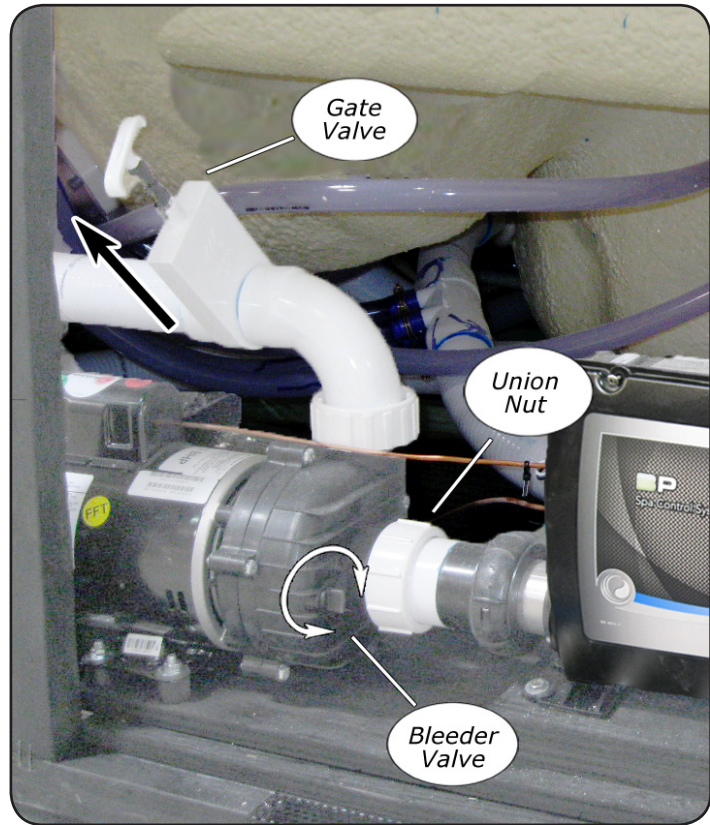

# Operating Your Spa

## TP400 and TP600 Control Panel Operation



TP400 Control Panel



TP600 Control Panels

### Primary Navigation and Functions

Navigating the entire menu structure is done with 2 or 3 buttons on the control panel.

You can use either Temperature button (Warm and Cool) to navigate and program where a single Temperature icon is shown.

The Light Button is also used to choose the various menus and navigate each section.

Typical use of the Temperature buttons allows changing the Set Temperature while the numbers are flashing in the LCD.

Pressing the LIGHT button while the numbers are flashing will enter the menus.



The menus can be exited with certain button presses. Waiting several seconds in any screen will allow the display to revert to the main screen.

Most changes are not saved unless the Light button is pressed.

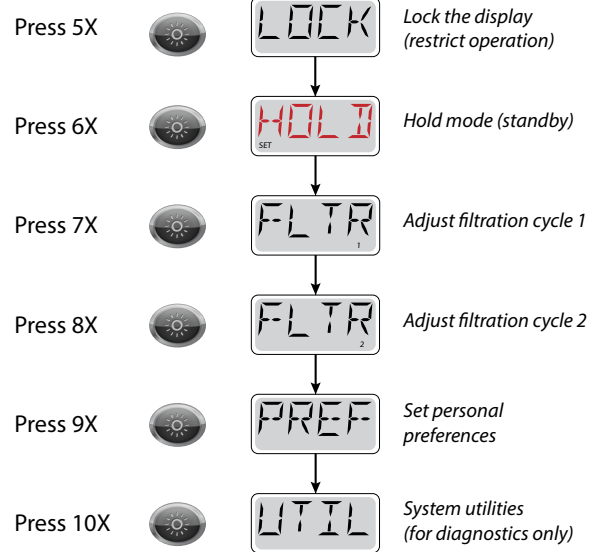
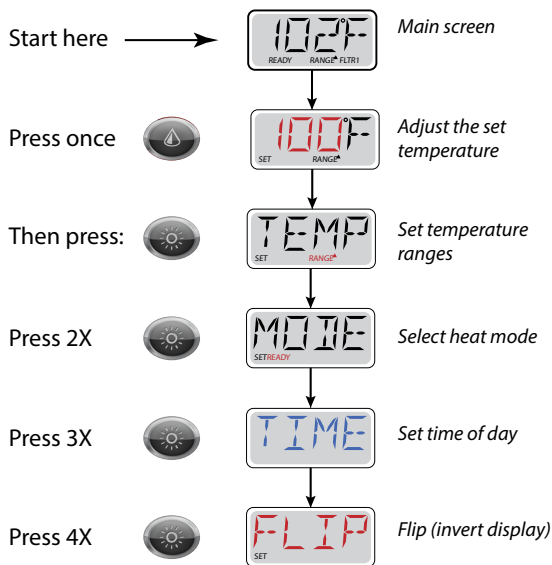

### Adjusting the Set Temperature

Press  Once

Press the WARM or COOL buttons to adjust the set temperature. When the temperature stops flashing, the spa will heat to the new set temperature when required. The temperature can be set between 60°F and 104°F.

Set Temp will show and flash

Press the Temp buttons to change the temperature.

Main Screen

### Setting Dual Temperature Ranges

Press  Once

Then Press  Once

You can set two temperature range settings with independent set temperatures. The High Range is shown in the display by an "up" arrow and the Low Range with a "down" arrow. The ranges can be used for different reasons, the most common being a "ready to use" setting versus a "vacation" setting. (See "Vacation Setting" below.) Each range maintains its own set temperature that you program according to your needs. This way, when a range is chosen, the spa will heat to the set temperature programmed to that range.

High Range can be set between 80°F and 104°F.

Low Range can be set between 50°F and 99°F.

The example below shows setting the Low Range temperature.

Select High Range or Low Range. Toggle the Range arrows on the display.

Set Temp will show and flash

Press a Temp Button repeatedly to change the temperature.

Main Screen

### Vacation Setting

Set the spa to operate in the Lower Range temperature choice before you go on vacation.

1. Press the Temp button. The "Set Temp" will show and flash.
2. Press the Light button. "TEMP" will show on the display, which give you the choice of High Range or Low Range.
3. To set the Low Range, press the Light button,
4. Press the Temp buttons to adjust the temperature.
5. Press the Light button or wait several seconds to return to the main screen.

## Setting the Heat Mode

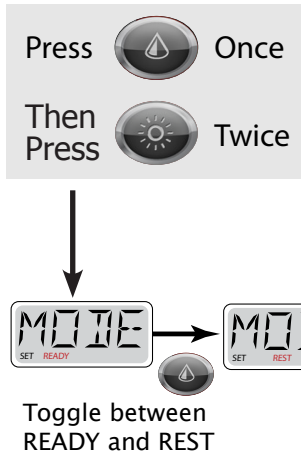

There are two heat modes: READY Mode and REST Mode.

**READY Mode:** In order for the spa to heat, a pump needs to circulate water through the heater. The pump that performs this function is known as the "heater pump."

The heater pump can be either a 2-Speed Pump 1 or a circulation pump. If the heater pump is a 2-Speed Pump 1, READY Mode will circulate water every 1/2 hour, using Pump 1 Low, in order to maintain a constant water temperature, heat as needed, and refresh the temperature display. This is known as "polling."

**REST Mode:** REST Mode will only allow heating during programmed filter cycles. Since polling does not occur, the temperature display may not show a current temperature until the heater pump has been running for a minute or two.

### Ready-in-Rest Mode

READY/REST appears in the display if the spa is in Rest Mode and Jet 1 is pressed. When the spa is being used, it will heat to set temperature. While Pump 1 High can be turned on and off, Pump 1 Low will run until set temperature is reached, or 1 hour has passed. After 1 hour, the system will revert to Rest Mode. This mode can also be reset by entering the Mode Menu and changing the Mode.

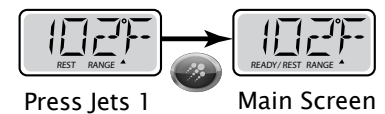

### Freeze Protection

If you live in an area that experiences extreme freezing weather, you need to know how to set your spa to prevent freeze damage. Some spa owners choose to drain and winterize their spas, but others prefer to keep it filled and operating. If you don't want to drain your spa, you can continue to run it safely through the winter, providing you program it correctly.

When you expect the temperature to approach freezing, always keep the spa in READY Mode. As long as the spa is in READY Mode, it will regularly check the water temperature (known as "polling") and circulate water every 1/2 hour.

When the sensors within the heater detect water temperature has dropped to 42°F (5.5°C), then the pumps and the blower automatically activate to provide freeze protection. The pumps and blower will run either continuously or periodically depending on conditions.

## Setting Time

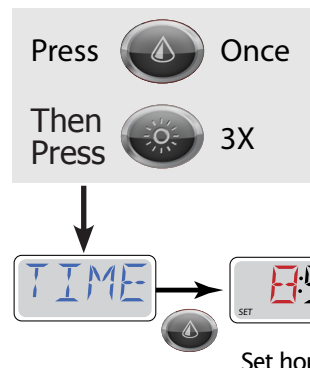

Setting the time of day is important for determining filtration times and other background features. 24-hour time display can be set under the PREF menu.

**Note: This system does NOT display the time of day. The default display on the Main Screen is the current water temperature. Displaying time of day is not a selectable feature.**



### Flip (Invert Display)

Press Once  
Then Press 4X

Inverting the display allows you to be able to read the control panel while you are in the spa.

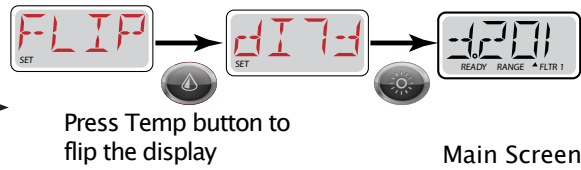

Press Temp button to flip the display

Main Screen

### Locking the Control

Press Once  
Then Press 5X

The control can be locked to prevent unwanted use or temperature adjustments. You can lock the set temperature or the control panel.

Locking the temperature allows Jets and other features to be used, but the Set Temperature and other programmed settings cannot be adjusted.

Locking the panel prevents the controller from being used, but all automatic functions are still active.

#### TO LOCK SET TEMPERATURE

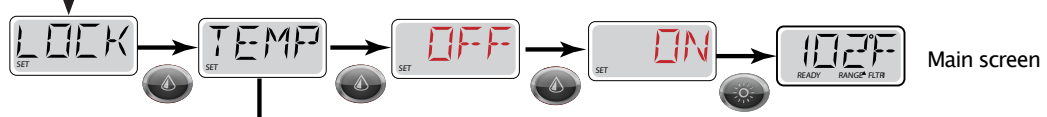

You can toggle between ON and OFF using the Warm and Cool buttons  
The set temperature has been locked

Press Light button to lock control panel

#### TO LOCK THE CONTROL PANEL



You can toggle between ON and OFF using the Warm and Cool buttons  
The control panel has been locked

### Unlocking the control

While pressing and holding the WARM Button, press the LIGHT button twice.

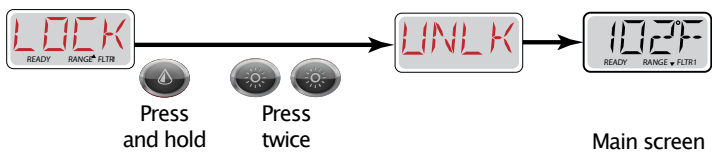

Main screen

Press Once  
Then Press 6X

### Hold Mode

Hold Mode is used to disable the pumps during service functions like cleaning or replacing the filter. (See page 39 for instruction on cleaning the filter.)

Hold Mode will last for 1 hour unless the mode is exited manually.



Timer will count down for 60 minutes

Main Screen

## Adjusting Filtration

### Main Filtration



Press  Once  
Then Press  7X

Filter cycles are set using a duration. Each setting can be adjusted in 15-minute increments. Filter Cycle 1 and Filter Cycle 2 (if enabled) are set to the same duration.

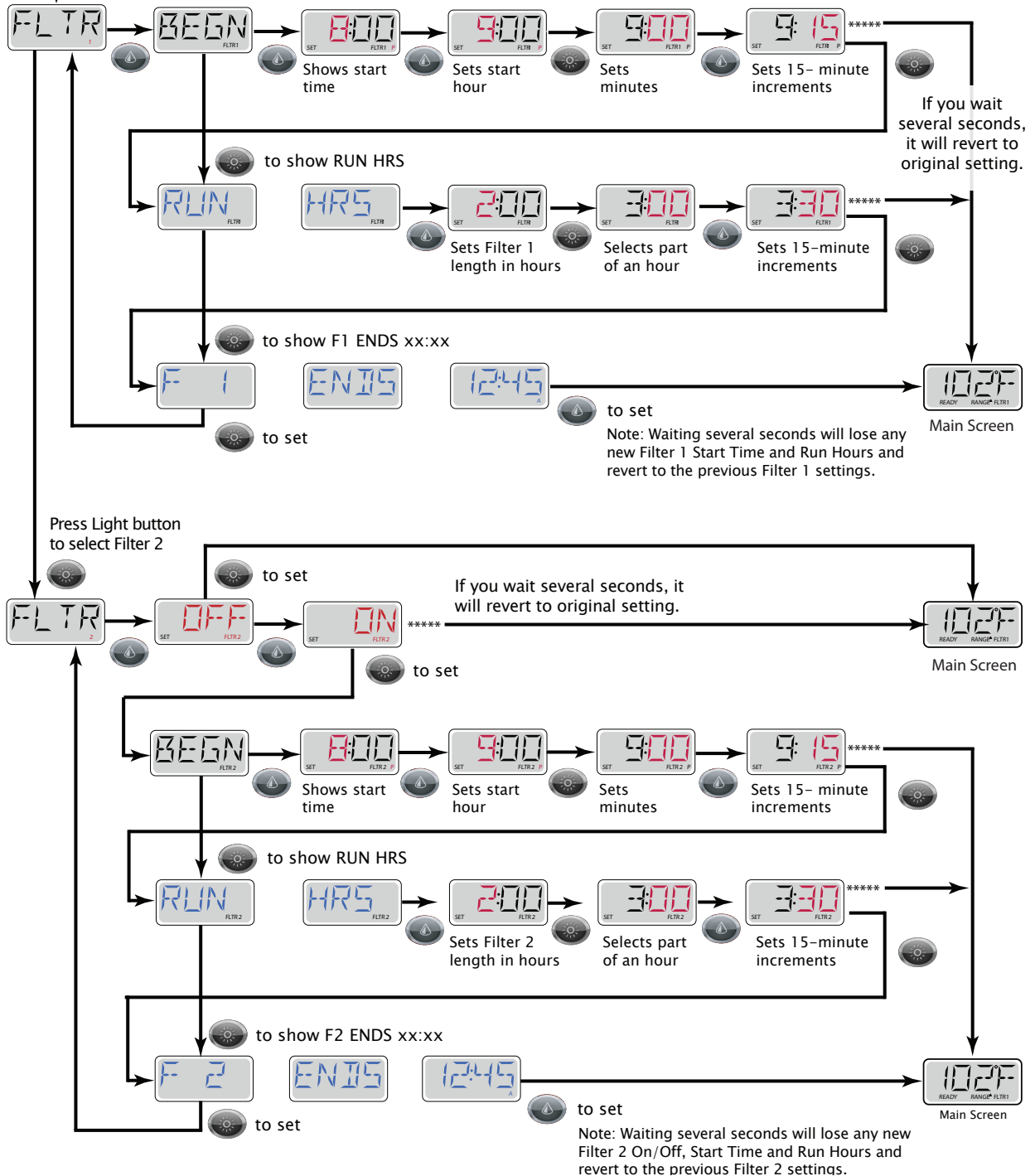
If Filter Cycle 2 is enabled, Filter 2 will appear in the LCD. If Filter 2 is disabled, Filter 1 will appear.



## Setting Preferences

Press  Once  
 Then Press  9X

This allows you to set the following preferences for system operation:

- Change the temperature between Fahrenheit and Celsius
- Change the clock between 12-hour and 24-hour display
- Turn periodic reminders (like "CLEAN FILTER") on or off

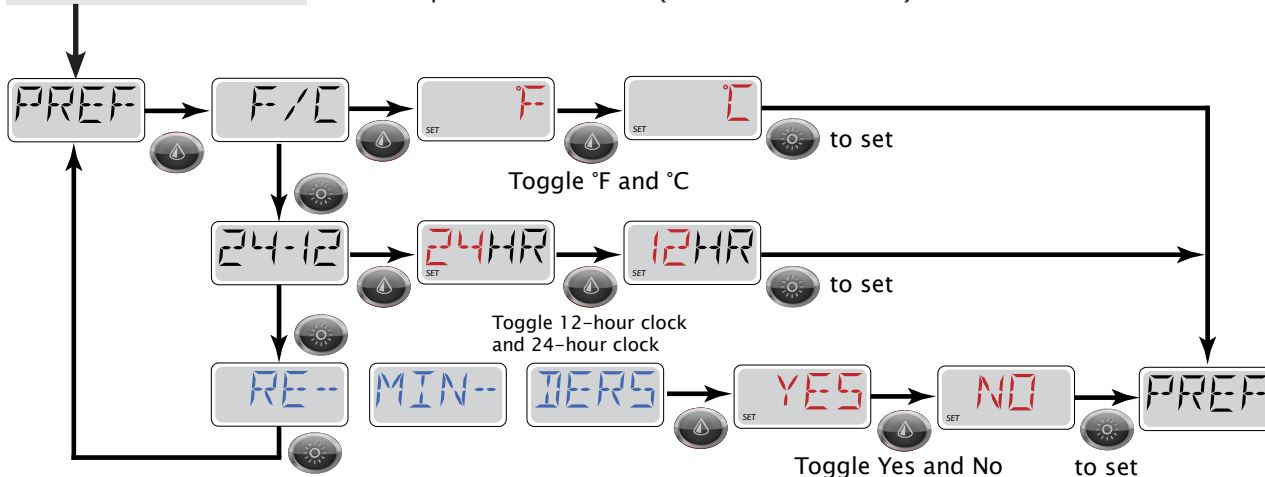

## Utilities

This menu feature is for system information only and is used mainly for repair and troubleshooting.

## Other Spa Systems

Several spa functions operate in the background and require no action or maintenance from you. This is for your information only.

### Pumps

Press the "Jets 1" button once to turn pump 1 on or off, and to shift between low- and high-speeds if equipped. If left running, the pump will turn off after a time-out period. The pump 1 low-speed will time out after 30 minutes. The high-speed will time out after 15 minutes.

On non-circ systems, the low-speed of pump 1 runs when the blower or any other pump is on. If the spa is in Ready Mode, Pump 1 low may also activate for at least 1 minute every 30 minutes to detect the spa temperature (polling) and then to heat to the set temperature if needed. When the low-speed turns on automatically, it cannot be deactivated from the panel, however the high speed may be started.

### Circulation Pump

The circulation pump will come on when the system is checking temperature (polling), during filter cycles, during freeze conditions, or when another pump is on.

The ozonator will run with the circulation pump during filtration cycles.

### Purge Cycles

In order to maintain sanitary conditions, secondary Pumps and/or a Blower will purge water from their respective plumbing by running briefly at the beginning of each filter cycle.

## Diagnostic Messages

Message	Meaning	Action Required
RUN PMPS PURG AIR	<p><b>Priming Mode</b></p> <p>Each time the spa is powered up, it will enter Priming Mode. The purpose of Priming Mode is to allow the user to run each pump and manually verify that the pumps are primed (air is purged) and water is flowing. This typically requires observing the output of each pump separately, and is generally not possible in normal operation.</p>	<p>Priming Mode lasts 4 minutes, but you can exit it earlier by pressing any Temp button. The heater is not allowed to run during Priming Mode.</p> <p>NOTE: If your spa has a Circ Pump, it will turn on with Jets 1 in Priming Mode. The Circ Pump will run by itself when Priming Mode is exited.</p>
---F - ---C	<p><b>Water Temperature Is Unknown</b></p> <p>After the pump has been running for 1 minute, the temperature will be displayed.</p>	None
42F TOO COLD	<p><b>Too Cold - Freeze Protection</b></p> <p>A potential freeze condition has been detected and all pumps and blower are activated. All pumps and blower are ON for at least 4 minutes after the potential freeze condition has ended. In some cases, pumps may turn on and off and the heater may operate during Freeze Protection.</p>	None.
WATR TOO HOT	<p><b>Water is Too Hot</b></p> <p>One of the water temp sensors has detected spa water temp 110°F (43.3°C) and spa functions are disabled.</p>	None. System will auto reset when the spa water temp is below 108°F (42.2°C). Check for extended pump operation or high ambient temp.
SFTY TRIP ----	<p><b>Safety Trip - Pump Suction Blockage</b></p> <p>The Safety Trip error message indicates that the vacuum switch has closed. This occurs when there has been a suction problem or a possible entrapment situation avoided. (Note: not all spas have this feature.)</p>	Drain or filter may be covered, creating a blockage. Clear the blockage and reset by pressing any button on the topside panel.
HTR FLOW LOSS ----	<p><b>Heater Flow Is Reduced</b></p> <p>There may not be enough water flow through the heater to carry the heat away from the heating element.</p>	Check for low water level, suction flow restrictions, closed valves, trapped air, too many closed jets and pump prime. Heater start up will begin again after about 1 minute.
HTR FLOW FAIL ----	<p><b>Heater Flow is Reduced</b></p> <p>There is not enough water flow through the heater to carry the heat away from the heating element and the heater has been disabled.</p>	Check for low water level, suction flow restrictions, closed valves, trapped air, too many closed jets and pump prime. Heater start up will begin again after about 1 minute.

Message	Meaning	Action Required
<b>HTR MAY BE DRY ---- WAIT ----</b>	<b>Heater May Be Dry</b> Possible dry heater, or not enough water in the heater to start it. The spa is shut down for 15 min.	Check for low water level, suction flow restrictions, closed valves, trapped air, too many closed jets and pump prime. Press any button to reset the heater start-up.
<b>HTR DRY ----</b>	<b>Heater Is Dry</b> There is not enough water in the heater to start it. The spa is shut down.	Check for low water level, suction flow restrictions, closed valves, trapped air, too many closed jets and pump prime. Press any button to reset the heater start-up.
<b>HTR TOO HOT ----</b>	<b>Heater Is Too Hot</b> One of the water temp sensors has detected 118°F (47.8°C) in the heater and the spa is shut down.	Check for low water level, suction flow restrictions, closed valves, trapped air, too many closed jets and pump prime. Press any button to reset when water is below 108°F (42.2°C).
<b>PRES BTTN TO RSET ----</b>	<b>Spa Needs To Be Reset</b> This message may appear with other messages.	Press any button on the topside control to reset.
<b>102F SNSR BAL- ANCE</b>	<b>Sensor Balance Is Poor</b> The temperature sensors MAY be out of sync by 2°F or 3°F.	Call for service.
<b>SNSR SYNC ---- CALL FOR SRVC ----</b>	<b>Sensor Balance is Poor</b> The temperature sensors ARE out of sync.	Call for service. Note: This message can be reset from the topside panel with any button press.
<b>SNSR A ---- CALL FOR SRVC SNSR B ---- CALLFOR SRVC</b>	<b>Sensor Failure</b> A temperature sensor or sensor circuit has failed.	Call for service.
<b>NO COMM</b>	<b>No Communications</b> The control panel is not receiving communication from the system.	Call for service.
<b>102°T</b>	<b>°F or °C is replaced by °T</b> The control system is in Test Mode.	Call for service.
<b>STUK PUMP ----</b>	<b>A Pump Appears To Be Stuck ON</b> Water may be overheated.	POWER DOWN THE SPA. DO NOT ENTER THE WATER. Call for service.
<b>HOT FALT ---- CALL FOR SRVC ----</b>	<b>A Pump Appears To Be Stuck ON</b> A pump appears to have been stuck ON when spa was last powered.	POWER DOWN THE SPA. DO NOT ENTER THE WATER. Call for service.

## TP800 Control Panel Operation



### The Main Screen

#### Spa Status

When the spa has finished priming, you will see the Main Screen. Important information about spa operation can be seen quickly from the Main Screen. The most important features can be accessed from this screen.

- The actual water temperature can be seen in large text and the desired, or Set Temperature, can be selected and adjusted.
- Time-of-day, ozone operation and filter operation status are shown, along with other messages and alerts.
- Temperature Range (High or Low) is indicated in the upper right corner.
- A Lock icon is visible if the panel or settings are locked.

#### Navigation

There are four selections you can make on the Main Screen:

**Set temperature** - Press the left arrow button to change the Set Temperature number to white. The

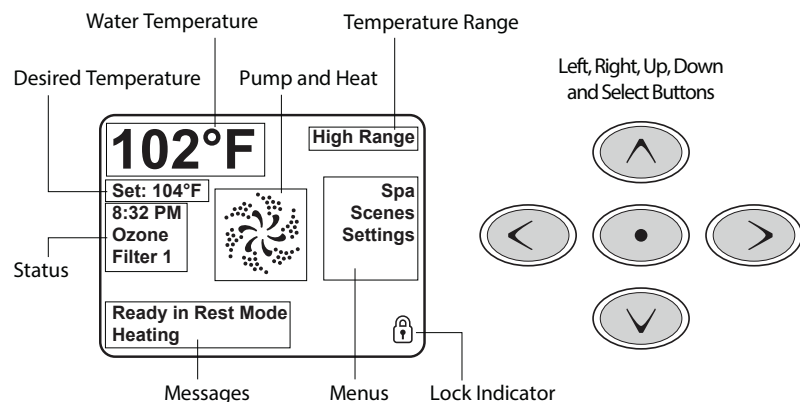

Set Temperature can then be adjusted with the up and down buttons. Pressing the Select button or the Right Arrow button will save the new set temperature.

**Menu selections** - The three menu choices on the right, **Spa**, **Shortcuts**, and **Settings**, can be selected and the screen will change to show more detailed controls or programming functions. They will be discussed further in this section.

#### Messages

At the bottom of the screen, messages may appear at various times. Some of these messages must be dismissed by the user (see page 24).

### Spa Screen

The Spa Screen shows all available equipment to control, as well as other features, like Invert, in one easy-to-navigate screen. The display shows icons that are related to the equipment installed on a particular spa model, so this screen may change depending on the installation.

The navigation buttons are used to select an individual device. The device that is chosen is highlighted with a white outline and the text under the icon changes to white. Once a device is selected, it can be controlled using the center Select Button.

Some devices, like pumps, may have more than one ON state, so the icon will change to reflect the state that the equipment is in. Below are some examples of 2-speed Pump indicators.

If the Spa has a Circ Pump, a Circ Pump Icon will appear to indicate its activity, but outside of Priming Mode, the Circ Pump cannot be controlled directly. NOTE: The icon for the pump that is associated with the heater (Circ or P1 Low) will have a red glow in the center when the heater is running.

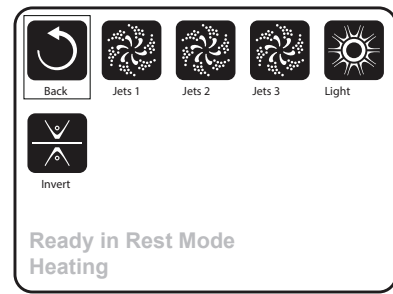

### Shortcut Screen

The Shortcut Screen requires no navigation.

Each button is fixed on a specific function and can be used as a very simple user interface for the spa.

Each button function is illustrated in the display and mapped according to the manufacturer's instructions.

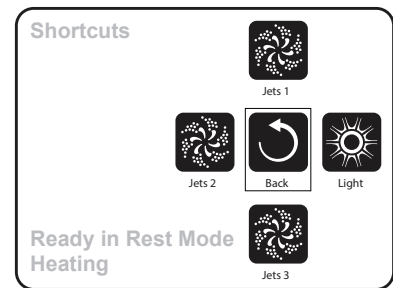

### Settings Screen

The Settings Screen is where all programming and other spa behaviors are controlled.

This screen has several features that can be acted on directly. These features include Temp Range, Heat Mode, and Invert Panel. When one of these items is highlighted, the Select Button is used to toggle between two settings. All other menu items (with an arrow pointing to the right) go to another level in the menu.

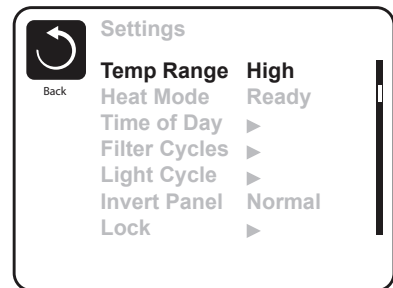

### Setting Time of Day

Setting the time of day is important for determining filtration times and other background features. "Set Time" will appear on the Main Screen if no time of day is set.

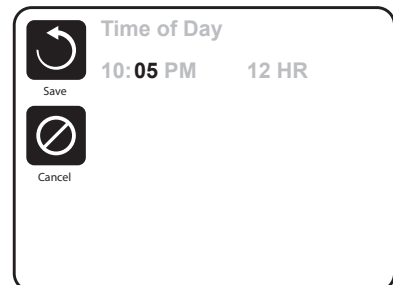

## Setting Dual Temperature Ranges

This system incorporates two temperature range settings with independent set temperatures. The specific range can be selected on the Settings screen and is visible on the Main Screen in the upper right corner of the display.

These ranges can be used for various reasons, with a common use being a “ready to use” setting vs. a “vacation” setting. Each range maintains its own set temperature as programmed by the user. This way, when a range is chosen, the spa will heat to the set temperature associated with that range.

High Range can be set between 80°F and 104°F. Low Range can be set between 50°F and 99°F. More specific Temp Ranges may be determined by the Manufacturer. Freeze Protection is active in either range.

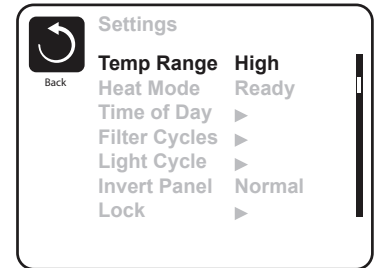

## Selecting Heat Modes – Ready vs. Rest

In order for the spa to heat, a pump needs to circulate water through the heater. The pump that performs this function is known as the “heater pump.”

The heater pump can be either a 2-speed pump (Pump 1) or a circulation pump. If the heater pump is a 2-Speed Pump 1, Ready Mode will circulate water every 1/2 hour, using Pump 1 Low, in order to maintain a constant water temperature, heat as needed, and refresh the temperature display. This is known as “polling.”

Rest Mode will only allow heating during programmed filter cycles. Since polling does not occur, the temperature display may not show a current temperature until the heater pump has been running for a minute or two. While Pump 1 High can be turned on and off, Pump 1 Low will run until set temperature is reached, or 1 hour has passed.

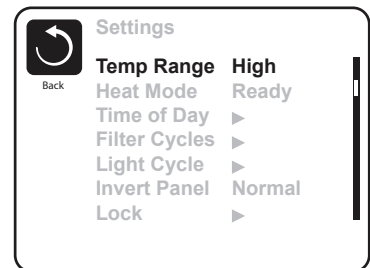

### Freeze Protection

If you live in an area that experiences extreme freezing weather, you need to know how to set your spa to prevent freeze damage. Some spa owners choose to drain and winterize their spas, but others prefer to keep it filled and operating. If you don't want to drain your spa, you can continue to run it safely through the winter, providing you program it correctly.

When you expect the temperature to approach freezing, always keep the spa in READY Mode. As long as the spa is in READY Mode, it will regularly check the water temperature (known as “polling”) and circulate water every 1/2 hour.

If the temperature sensors within the heater detect a low enough temperature, then the pumps and the blower automatically activate to provide freeze protection. The pumps and blower will run either continuously or periodically depending on conditions.

## Setting Filter Cycles

Filter cycles are set using a start time and a duration. Each setting can be adjusted in 15-minute increments. The panel calculates the end time and displays it automatically.

Filter cycle 2 is off by default, but can be selected for use if desired.

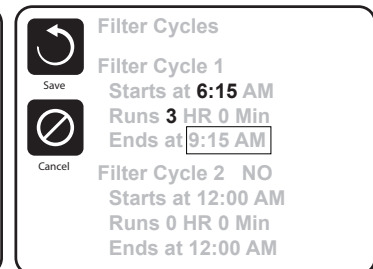
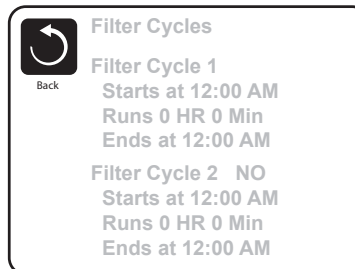



### Ready-in-Rest Mode

READY/REST appears in the display if the spa is in Rest Mode and the Jets 1 Button is pressed. It is assumed that the spa is being used and will heat to set temperature. While Pump 1 High can be turned on and off, Pump 1 Low will run until set temperature is reached, or 1 hour has passed. After 1 hour, the System will revert to Rest Mode. This mode can also be reset by entering the Settings Menu and changing the Heat Mode.

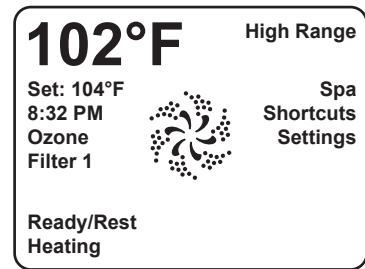

### Circulation Mode

If the spa is configured for 24HR circulation, the heater pump generally runs continuously. Since the heater pump is always running, the spa will maintain set temperature and heat as needed in Ready Mode, without polling. In Rest Mode, the spa will only heat to set temperature during programmed filter times, even though the water is being filtered constantly when in Circulation Mode.

### Locking and Unlocking the Control Panel

The control can be restricted to prevent unwanted use or temperature adjustments.

Locking the Settings allows jets and other features to be used, but the set temperature and other programmed settings cannot be adjusted.

When settings are locked, there is a reduced selection of menu items. These include Set Temperature, Invert, Lock, Utilities, Information and Fault Log. They can be seen, but not changed or edited.

Locking the Panel prevents the controller from being used, but all automatic functions are still active.

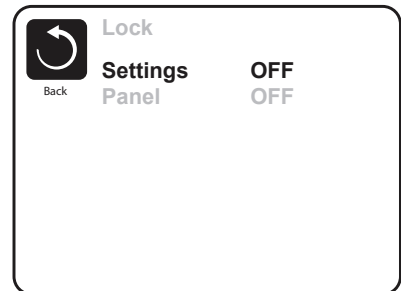

**Locking and Unlocking** -- Use the navigation buttons from the Lock Screen. The Lock and Unlock Sequence is the same for both Panel Lock and Settings Lock.

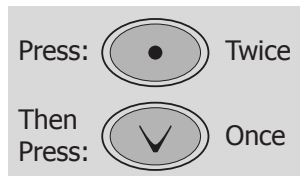

### Additional Settings

#### Light Cycle

If Light Cycle does not appear in the Settings Menu, the light timer feature is not enabled by the manufacturer. When available, the light timer is OFF by default. The settings can be edited the same way as filter cycles.

#### Invert Panel

Selecting Invert Panel will flip the display and the buttons so the panel can be easily operated from inside or outside the hot tub.

#### Hold

Hold Mode is used to disable the pumps during service functions like cleaning or replacing the filter. (See page 39 for instruction on cleaning the filter.)

Hold Mode will last for 1 hour unless the mode is exited manually.

#### Utilities

This menu feature is for system information only and is used mainly for repair and troubleshooting.

### Preferences

This allows you to set the following preferences for system operation:

- Change the temperature between Fahrenheit and Celsius
- Change the clock between 12-hour and 24-hour display

- Turn periodic reminded (like "CLEAN FILTER") on or off

### Information

This menu feature is for system information only and is used mainly for repair and troubleshooting.

## Diagnostic Messages

Message	Meaning
---F - ---C	Water temperature is unknown. After the pump has been running for one minute, the temperature will be displayed.
Possible freezing condition	A potential freeze condition has been detected. All water devices are activated. In some cases, pumps may turn on and off and the heater may operate during Freeze Protection. This is an operational message, not an error indication.
The water is too hot	The system has detected a spa water temp of 110°F (43.3°C) or more, and spa functions are disabled. System will auto reset when the spa water temp is below 108°F (42.2°C). Check for extended pump operation or high ambient temp.
Water flow is low	There may not be enough water flow through the heater to carry the heat away from the heating element. Heater start up will begin again after about 1 min. See "Flow Related Checks" below.
Water flow has failed	There is not enough water flow through the heater to carry the heat away from the heating element and the heater has been disabled. See "Flow Related Checks" below. After the problem has been resolved, you must press any button to reset and begin heater start up.
The heater may be dry	Possible dry heater, or not enough water in the heater to start it. The spa is shut down for 15 min. Press any button to reset the heater start-up. See "Flow Related Checks" below.
The heater is dry	There is not enough water in the heater to start it. The spa is shut down. After the problem has been resolved, you must clear the message to restart heater start up. See "Flow Related Checks" below.
The heater is too hot	One of the water temp sensors has detected 118°F (47.8°C) in the heater and the spa is shut down. You must clear the message when water is below 108°F (42.2°C). See "Flow Related Checks" below.
Sensors are out of sync	The temperature sensors MAY be out of sync by 2°F or 3°F. Call for service.
Sensors are out of sync -- Call for service	The temperature sensors ARE out of sync. The fault above has been established for at least 1 hour. Call for service.
Sensor A Fault, Sensor B Fault	A temperature sensor or sensor circuit has failed. Call for service.
Communications error	The control panel is not receiving communication from the System. Call for service.
°F or °C is replaced by °T	The Control System is in Test Mode. Call for service.

### Flow-Related Checks

Check for low water level, suction flow restrictions, closed valves, trapped air, too many closed jets and pump prime. On some systems, even when spa is shut down by an error condition, some equipment may occasionally turn on to continue monitoring temperature or if freeze protection is needed.

# spaTouch Icon Driven Control Panel



## The Main Screen (Home)

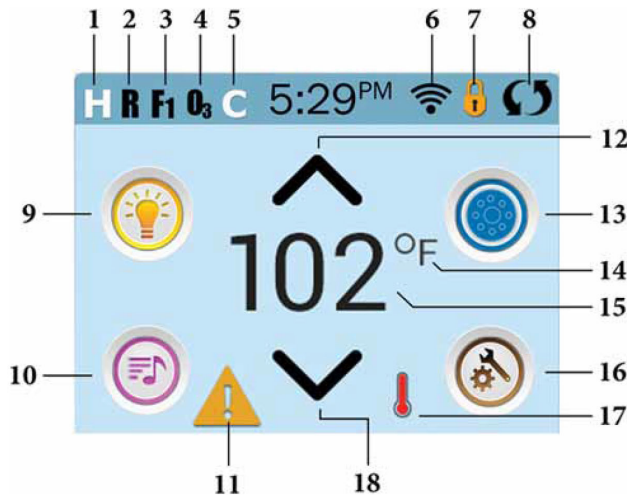

Note: After 30 minutes\* the display will automatically go into sleep mode, which turns the display off. This is normal operation. Touch anywhere on the screen to wake the panel up.

### ICON Specifications

- 1. H = High Temperature Range
- 2. R = Ready Mode
- 3. F1 = Filter Cycle 1 Running
- 4. O3 = Ozone Running
- 5. C = Cleanup Cycle
- 6. Wi-Fi Signal Indicator
- 7. Lock Indicator Icon
- 8. Invert Screen
- 9. Light Icon = Turns On/Off
- 10. Music Icon = Press To Enter Music Screen
- 11. Message Waiting Indicator
- 12. Set Temperature Up
- 13. Spa Equipment Control Icon
- 14. Temperature Scale (F/C)
- 15. Current Water Temperature
- 16. Settings Icon
- 17. Heat Indicator
- 18. Set Temperature Down

### Navigation

Navigating the entire menu structure is done by touching the screen. The three screen selections indicated below can be selected. Touch one of these to enter a different screen with additional controls. Most menu screens time out and revert to the main screen after 30 seconds of no activity.

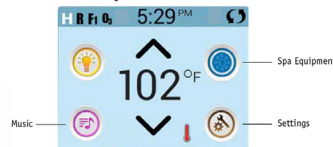

### Messages

At the bottom of the screen, at certain times an indicator may appear showing that a message is waiting. Touch this indicator to go to the Message Display Screen. On that Screen some of the messages can be dismissed.

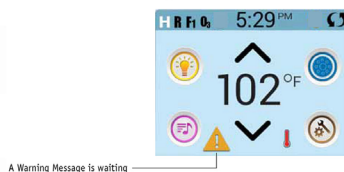

### Set Temperature

Press Up or Down once to display the Set Temperature (indicated by a flashing °F or °C, plus a change in color of the temperature). Press Up or Down again to modify the Set Temperature. The Set Temperature changes immediately.

If you need to switch between High Temperature Range and Low Temperature Range you need to go to the Settings Screen.

### Press-and-Hold

If Up or Down is pressed and held, the temperature will continue to change until you stop pressing, or until the Temperature Range limits are reached.

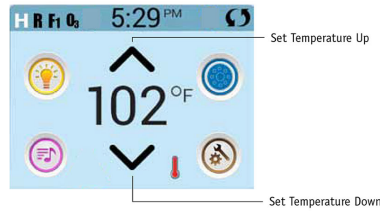

### All Equipment Access

The Spa Screen shows all available equipment\* to control. The display shows icons that are related to the equipment installed on a particular spa model, so this screen may change depending on the installation.

The icon buttons are used to select and control individual devices.

Some devices, like pumps, may have more than one ON state, so the icon will change to reflect the state of the equipment. Below are some examples of 2-speed Pump indicators.



If the Spa has a Circ Pump, a Circ Pump Icon will appear to indicate its activity, but outside of Priming Mode, the Circ Pump cannot be controlled directly.

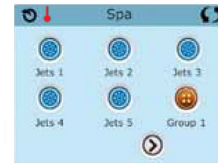

### Values Increment/Decrement

If an Up or Down button is shown and pressed when on an editing page, and a value has been selected (highlighted), the value can be incremented by pressing the up arrow or decremented by pressing the down arrow.

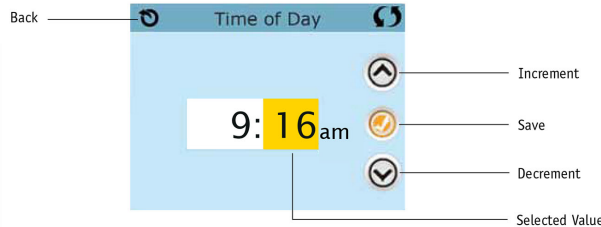

### Invert

Will appear on upper right on all screens.



### Exiting Screens

The Back button is on every screen except the Main Screen, the Priming Mode Screen are a Message Display Screen.

When you see only this button, or this button plus an Inactive Save Button, it means Back or Exit. It appears on editing screens before you have changed any value, as well as on all other screens.

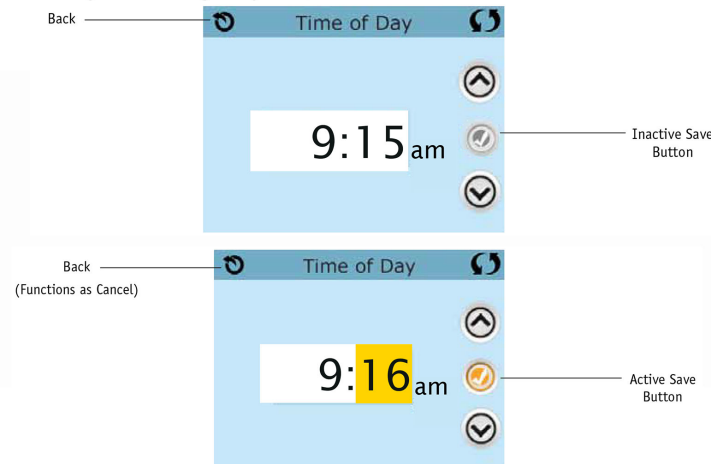

When you see both the Back button and an Active Save button, the Save button will Save, while the Back button will Cancel. If the screen times out due to no activity it will act like Cancel.

### Page Right/Left

If there is a right arrow at the bottom of the screen, it takes you to the next page.

If there is a left arrow at the bottom of the screen, it takes you to the previous page.



### Page Up/Down

If an Up or Down button is shown and pressed when on a page with a text list, the list can be scrolled a page at a time.



### Programming, Etc.

The Settings Screen is where all programming and other spa behaviors are controlled.

Each icon on the Settings screen takes you to a different screen, where one or more setting may be viewed and/or edited.



The Heat Icon  takes you to a screen where you control the Heat Mode and the Temperature Range.

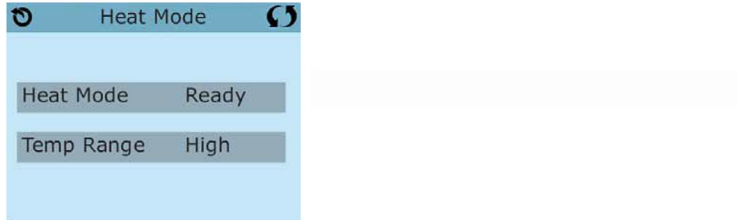

### Dual Temperature Ranges (High vs. Low)

This system incorporates two temperature range settings with independent set temperatures. The specific range can be selected on the Settings screen and is visible on the Main Screen in the upper left corner of the display.

These ranges can be used for various reasons, with a common use being a "ready to use" setting vs. a "vacation" setting. Each range maintains its own set temperature as programmed by the user. This way, when a range is chosen, the spa will heat to the set temperature associated with that range.

*High Range can be set between 80°F and 104°F. More specific Temp Ranges may be determined by the Manufacturer.*  
*Low Range can be set between 50°F and 99°F. Freeze Protection is active in either range.*

### Heat Mode – Ready vs. Rest

In order for the spa to heat, a pump needs to circulate water through the heater. The pump that performs this function is known as the "heater pump."

The heater pump can be either a 2-speed pump (Pump 1) or a circulation pump.

If the heater pump is a 2-Speed Pump 1, Ready Mode will circulate water every 1/2 hour, using Pump 1 Low, in order to maintain a constant water temperature, heat as needed, and refresh the temperature display. This is known as "polling."

Rest Mode will only allow heating during programmed filter cycles. Since polling does not occur, the temperature display may not show a current temperature until the heater pump has been running for a minute or two.

When the heater pump has come on automatically (for example for heating) you can switch between low speed and high speed but you cannot turn the heater pump off.

### Circulation Mode (See Page 13, under Pumps, for other circulation modes)

If the spa is configured for 24HR circulation, the heater pump generally runs continuously. Since the heater pump is always running, the spa will maintain set temperature and heat as needed in Ready Mode, without polling.

In Rest Mode, the spa will only heat to set temperature during programmed filter times, even though the water is being filtered constantly when in 24HR circulation mode.

### Ready-in-Rest Mode

Ready in Rest Mode appears in the display if the spa is in Rest Mode and the Jets 1 Button is pressed. When the heater pump has come on automatically (for example for heating) you can switch between low speed and high speed but you cannot turn the heater pump off. After 1 hour, the System will revert to Rest Mode. This mode can also be reset by selecting the Heat Mode line on the Screen shown here.

## Priming Mode – M019

After the initial start-up sequence, the control will enter Priming Mode and display a Priming Mode screen. Only pump icons appear on the priming mode screen. During the priming mode, the heater is disabled to allow the priming process to be completed without the possibility of energizing the heater under low-flow or no-flow conditions. Nothing comes on automatically, but the pump(s) can be energized by selecting the “Jet” buttons. If the spa has a Circ Pump, it can be turned on and off by pressing the “Circ” button during Priming Mode.

## Exiting Priming Mode

The system will automatically enter the normal heating and filtering at the end of the priming mode, which lasts 4-5 minutes.

— — — — °F      — — — — °C

## Filtration and Ozone

On non-circ systems, Pump 1 low and the ozone generator will run during filtration. On circ systems, the ozone will generally run with the circ pump, but can be limited to filtration cycles. (On some circs systems, Pump 1 low will run along with the circ Pump during filtration.)

The system is factory-programmed with one filter cycle that will run in the evening (assuming the time-of-day is properly set) when energy rates are often lower. The filter time and duration are programmable. A second filter cycle can be enabled as needed.

At the start of each filter cycle, the water devices like blower, mister device (if these exist) and other pumps will run briefly to purge the plumbing to maintain good water quality.

## Freeze Protection

If the temperature sensors within the heater detect a low enough temperature, then the water devices automatically activate to provide freeze protection. The water devices will run either continuously or periodically depending on conditions.

In colder climates, an optional freeze sensor may be added to protect against freeze conditions that may not be sensed by the standard sensors. Auxiliary freeze sensor protection acts similarly except with the temperature thresholds determined by the switch. See your dealer for details.

## Clean-up Cycle (optional)

When a pump or blower is turned on by a button press, a clean-up cycle begins 30 minutes after the pump or blower is turned off or times out. The pump and the ozone generator will run for 30 minutes or more, depending on the system. On some systems, you can change this setting.

## Be sure to set the Time-of-Day

Setting the time-of-day is important for determining filtration times and other background features.

The Heat Icon  on the Settings Screen takes you to a screen where you control the Time-of-Day.

On the Time-of-Day screen, simply select the Hours and Minutes. Use the Up and Down Buttons to make changes, then Save.

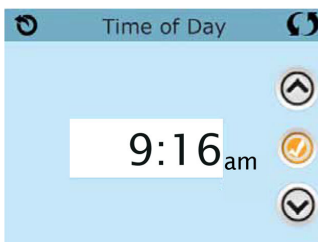

If no time-of-day is set in the memory an Information Screen will appear. If you exit it and Information Icon will appear at the bottom of the Main Screen, until the time-of-day has been set.

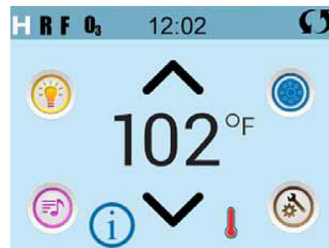

### Note:

This only applies to some systems:

If power is interrupted to the system,

Time-of-Day will be maintained for several days.

### Main Filtration

Using the same adjustment as Setting the Time, Filter Cycles are set using a start time and a duration. Each setting can be adjusted in 15-minute increments. The panel calculates the end time and displays it automatically.

The Filter Icon  on the Settings Screen takes you to a screen where you control the Filter Cycles.

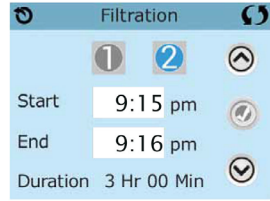

### Filter Cycle 2 - Optional Filtration

Filter Cycle 2 is OFF by default.

Viewing Filter 1 while Filter 2 is OFF:



Viewing Filter 1 while Filter 2 is ON:

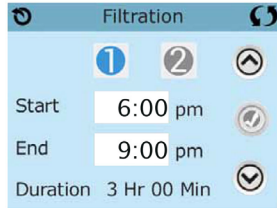

Press "1" to view Filter 1. Press "2" once to view Filter 2. Press "2" again to turn Filter 2 ON or OFF.

When Filter Cycle 2 is ON, it can be adjusted in the same manner as Filter Cycle 1.

It is possible to overlap Filter Cycle 1 and Filter Cycle 2, which will shorten overall filtration by the overlap amount.

### Light Cycle Option

If Light Cycle does not appear on the Settings Screen, the Light Timer feature is not enabled by the manufacturer.

The Light Cycle Icon  on the Settings Screen takes you to a screen where you control the Light Cycle.

When available, the Light Timer is ("Disabled") by default. Press "Disabled" to change it to "Enabled" (ON).

The settings can be edited the same way that Filter Cycles are edited.



### Restricting Operation



The control can be restricted to prevent unwanted use or temperature adjustments.

Locking the Panel prevents the controller from being used, but all automatic functions are still active.

Locking the Settings allows Jets and other features to be used, but the Set Temperature and other programmed settings cannot be adjusted.

Settings Lock allows access to a reduced selection of menu items. These include Filter Cycles, Invert, Information and Fault Log. They can be seen, but not changed or edited.

### Locking and Unlocking

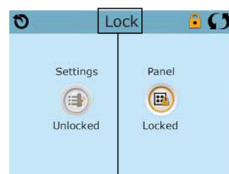

Press here for 5 seconds to lock or unlock.

The same steps are used to Lock and Unlock.

To lock either Settings or Panel first select Settings (if it says "Unlocked") or Panel (if it says "Unlocked"), then press the word "Lock" for at least 5 seconds.

To unlock either Settings or Panel first select Settings (if it says "Locked") or Panel (if it says "Locked"), then press the word "Lock" for at least 5 seconds.

## Hold - M037

Hold Mode is used to disable the pumps during service functions like cleaning or replacing the filter. Hold Mode will last for 1 hour unless the mode is exited manually. If spa service will require more than an hour, it may be best to simply shut down power to the spa.

The Hold Icon  on the Settings Screen places the spa in Hold Mode and displays the System Hold screen. Touch Back to exit Hold Mode.

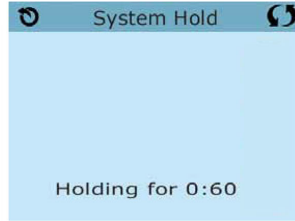

## Drain Mode

Some spas have a special feature that allows Pump 1 to be employed when draining the water. When available, this feature is a component of Hold Mode.

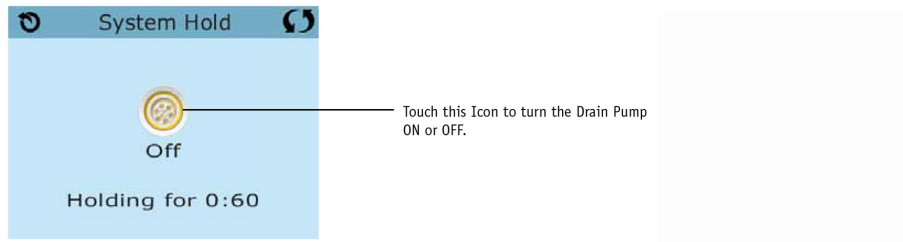

## Utilities

The Utilities Icon  on the Settings Screen takes you to the Utilities Screen.

The Utilities Screen contains the following:

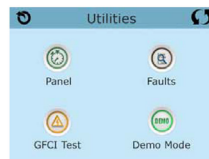

### Panel

Touching the Panel Icon  on the Utilities Screen takes you to the Panel Screen, where you can set how long it takes the panel to go to sleep after the last activity. The Sleep Timer can be set from 1 minute to 60 minutes. The default is 30 minutes.

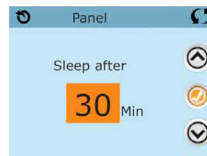

### Demo Mode

Demo Mode is not always enabled, so it may not appear. This is designed to operate several devices in a sequence in order to demonstrate the various features of a particular hot tub.

### Fault Log

The Fault Log is a record of the last 24 faults that can be reviewed by a service tech.

Use the Up and Down buttons to view each of the Faults.

When Priming Mode shows in the Fault Log, it is not a fault. Rather, it is used to keep track of spa restarts.

### Units Screen

The Units Icon  on the Settings Screen takes you to the Units Screen.

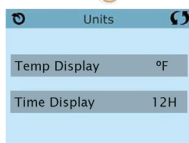

Press "Temp Display" to change the temperature between Fahrenheit and Celsius.  
Press "Time Display" to change the clock between 12 hr and 24 hr display.

### Reminders

The Reminder Icon  on the Settings Screen takes you to the Reminders screen.

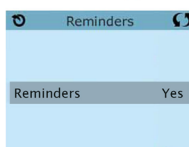

Press "Reminders" to turn the reminder messages (like "Clean Filter") ON (Yes) or OFF (No).

### Cleanup Cycle

Cleanup Cycle Duration is not always enabled, so it may not appear. When it is available, set the length of time Pump 1 will run after each use. 0-4 hours are available. Settings it to 0.0 Hr keeps the Cleanup Cycles from running.

The Cleanup Icon  on the Settings Screen takes you to the Cleanup Cycle screen.

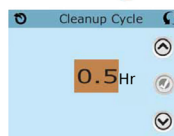

### Language

The Language Icon  on the Settings Screen takes you to the Language screen.

Change the language displayed on the panel.





Most messages and alerts will appear at the bottom of the normally used screens. Several alerts and messages may be displayed in a sequence.

---°F ---°C

### Water Temperature is Unknown

After the pump has been running for 1 minute, the temperature will be displayed.



### Possible freezing condition

A potential freeze condition has been detected, or the Aux Freeze Switch has closed. All water devices are activated. In some cases, pumps may turn on and off and the heater may operate during Freeze Protection. This is an operational message, not an error indication.

### The water is too hot – M029

The system has detected a spa water temp of 110°F (43.3°C) or more, and spa functions are disabled. System will auto reset when the spa water temp is below 108°F (42.2°C). Check for extended pump operation or high ambient temp.

## Heater-Related Messages

### The water flow is low – M016

There may not be enough water flow through the heater to carry the heat away from the heating element. Heater start up will begin again after about 1 min. See "Flow Related Checks" below.

### The water flow has failed\* – M017

There is not enough water flow through the heater to carry the heat away from the heating element and the heater has been disabled. See "Flow Related Checks" below. After the problem has been resolved, reset the message\*.

### The heater may be dry\* – M028

Possible dry heater, or not enough water in the heater to start it. The spa is shut down for 15 min. Reset this message\* to reset the heater start-up. See "Flow Related Checks" below.

### The heater is dry\* – M027

There is not enough water in the heater to start it. The spa is shut down. After the problem has been resolved, you must reset the message\* to restart heater start up. See "Flow Related Checks" below.

### The heater is too hot\* – M030

One of the water temp sensors has detected 118°F (47.8°C) in the heater and the spa is shut down. You must reset the message\* when water is below 108°F (42.2°C). See "Flow Related Checks" below.

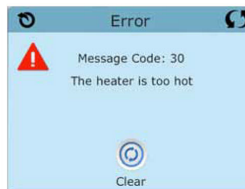

### Flow-Related Checks

Check for low water level, suction flow restrictions, closed valves, trapped air, too many closed jets and pump prime. On some systems, even when spa is shut down by an error condition, some equipment may occasionally turn on to continue monitoring temperature or if freeze protection is needed.

\* **Some messages can be reset from the panel.** Messages that can be reset will appear with a Clear Icon at the bottom of the Message Screen. Press the Clear Icon text to reset the message.

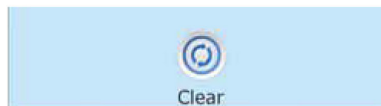

## Sensor-Related Messages

### Sensors are out of sync – M015\*\*

The temperature sensors MAY be out of sync by 3°F. Call for Service if this message does not disappear within a few minutes.

### Sensors are out of sync -- Call for service\* – M026\*\*

The temperature sensors ARE out of sync. The fault above has been established for at least 1 hour. Call for Service.



### Sensor A Fault, Sensor B Fault – Sensor A: M031\*\*, Sensor B: M032\*\*

A temperature sensor or sensor circuit has failed. Call for Service.

## Miscellaneous Messages

### Communications error

The control panel is not receiving communication from the System. Call for Service.

### Test software installed

The Control System is operating with test software. Call for Service.

\* *Some messages can be reset from the panel.* Messages that can be reset will appear with a Clear Icon at the bottom of the Message Screen. Press the Clear Icon text to reset the message.

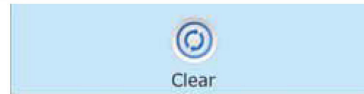

\*\*M0XX is a Message Code. Codes like this will be seen in the Fault Log

## System-Related Messages

### Program memory failure\* – M022\*\*

At Power-Up, the system has failed the Program Checksum Test. This indicates a problem with the firmware (operation program) and requires a service call.

### The settings have been reset (Persistent Memory Error)\* – M021\*\*

Contact your dealer or service organization if this message appears on more than one power-up.

### The clock has failed\* – M020\*\*

Contact your dealer or service organization.

### Configuration error (Spa will not Start Up)

Contact your dealer or service organization.

### The GFCI test failed (System Could Not Test the GFCI) – M036\*\*

(North America Only) May indicate an unsafe installation. Contact your dealer or service organization.

### A pump may be stuck on – M034\*\*

Water may be overheated. POWER DOWN THE SPA. DO NOT ENTER THE WATER. Contact your dealer or service organization.

### Hot fault – M035\*\*

A Pump Appears to have been Stuck ON when spa was last powered. POWER DOWN THE SPA. DO NOT ENTER THE WATER. Contact your dealer or service organization.

\* *Some messages can be reset from the panel.* Messages that can be reset will appear with a Clear Icon at the bottom of the Message Screen. Press the Clear Icon text to reset the message.



\*\*M0XX is a Message Code. Codes like this will be seen in the Fault Log

## Cal Spas Hot Tub Wi-Fi App

The Cal Spas Hot Tub Wi-Fi app can provide you with instant access and control of your spa wherever you connect within the spa's Wi-Fi range. This optional feature is available for use with any smart device (Android™ or iOS™ systems only). You must have the Wi-Fi module installed in your spa in order to use the app. It is only available for spas with the BP501 or BP2000 control box.

Spa owners who do not have this feature installed on their spa at the factory can order it as an after-market item.

### Installing the app

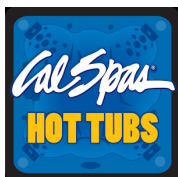

Go to the Apple app store or Google Play and search for the free spa app using the key words "Cal Spas Hot Tub." Select the app. The icon for the app will appear on your device as shown at left.

**Make sure you enable Wi-Fi on your phone before you run the app.**

On the Wi-Fi connections screen on your device, a network will appear called "BWGSpa\_XXXXXX\_". (The x's represent the Wi-Fi module's local address and is unique for every spa.) Once you are connected to the network, start the Cal Spas app and follow the prompts on the screen. (Your start screen maybe different.)

1. Tap the app button on the main screen of your device.
2. Connect to the spa's Wi-Fi signal.
3. When connected, you will be taken to the main app screen.
4. You are now directly connected to your hot tub and can control all the hot tub functions via the app.

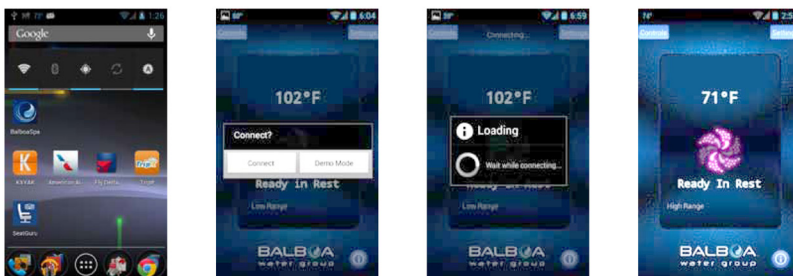

### Troubleshooting connection problems

You should have few problems connecting with the Wi-Fi app. However, if you are unable to connect quickly and easily to the spa's Wi-Fi source, try doing the following.

- Enable Wi-Fi on your device. This is the most likely reason you may not be able to connect to the app. Check your devices Wi-Fi settings and try connecting again.
- Power cycle the spa. Shut off power to the spa for 30 second and turn it back on. Wait until the spa has gone through its complete set-up routine before you try to connect with the Wi-Fi app.
- Wait until the spa has completely primed. When you turn on the spa, it will go through a priming routine, which is followed by temperature polling, where no temperature is shown on the control panel. As soon as a temperature appears, you can connect with the Wi-Fi app.
- If you use your home network router, it MUST be close enough to the spa in order for the spa's Wi-Fi signal to reach the router. If you have connectivity problems, you may need to relocate your router closer to your spa or consider adding a wireless signal booster to your router.

## Connecting to a Device or Network

### 1 Direct connection

Range: About 20 feet  
Range limit: Limited to the range of the wi-fi module



#### HOW TO CONNECT TO IT:

Install the app on your phone or device -- see the following section "Installing the app".

### 2 Through home network with no internet access

#### Allows one local connection at a time

Range: About 50 feet  
Range limit: Limited to the range of your home router's signal



#### HOW TO CONNECT TO IT:

1. Install the app on your phone or device.
2. Exit the app and go to wi-fi settings on your phone or device.
3. Select and enable your local router.
4. Start the app. After you connect, select Settings on the home screen.
5. On the Settings screen, select Advanced, then on the Advanced screen, select Wi-fi Settings.
6. On the Wi-fi screen, select WPA. Then select the name of your home router from the drop-down menu.
7. Enter the SSID and Key for your router, then tap Save and select OK twice.
8. Close the app and re-start it to connect to your home network.

### 3 Through a network with internet access, using Cloud connection or other hotspot connection

#### Allows unlimited simultaneous connections

Range: Worldwide  
Range limit: Limited to 3G / 4G / hotspot availability

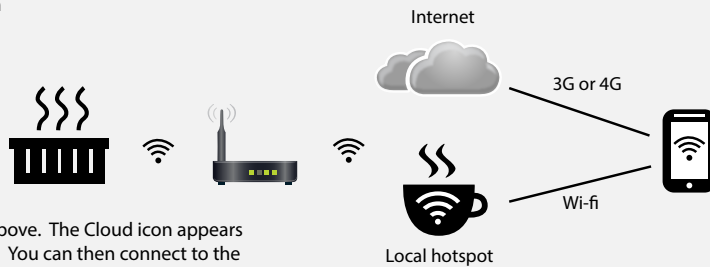

#### HOW TO CONNECT TO IT:

Follow connection instructions from section (2) above. The Cloud icon appears automatically when network connection is made. You can then connect to the spa's wi-fi module.

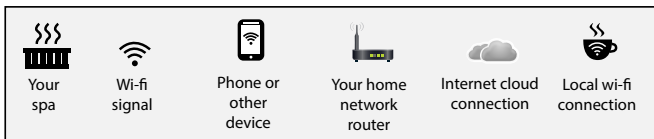

## Cloud Service

Cal Spas Wi-Fi can be used as a point to point remote control to be added to any home network free of charge. Those using the Cloud to access spa control from nearly anywhere in the world via the Internet will enjoy one year Cloud service free of any access charge. After the initial year of Cloud service, the user will receive a notice from the Cloud provider requiring a small charge for each continuing year of Cloud service. At the time of this publication, the annual fee for this service is \$24. Once your device is paired and connected, all sounds from your device will be played through the spa's optional sound system, including system sounds and telephone messages. The Wi-Fi package contents are pictured below.



Cal Spas app



Cal Spas WiFi Module  
Part # ELE 50350-04



1 Year of Cloud  
Remote Access\*

\* You will receive a notification approximately 45 days prior to the end of the expiration of your Cloud access with instructions on how to renew.

### For More Information

If you have any trouble connecting, you can find more in-depth instructions at the Balboa Water Group web site at [www.balboawatergroup.com/bwa](http://www.balboawatergroup.com/bwa) and download the PDF document "Setting Up Your Wi-Fi".

There are also installation and setup videos at [www.youtube.com/user/balboawatergroup](http://www.youtube.com/user/balboawatergroup).

### Electrical Power Efficiency

Your new spa comes equipped with an electric heater. Following the directions listed below will ensure the most efficient operation:

NOTE: This method is only for spa usage under two hours a week.

- Keep the spa's operating temperature 5°F below the desired usage temperature when not in use. One or two hours before use, set the temperature to the desired temperature.
- If the spa usage exceeds two hours a week, the set temperature should remain at the desired usage temperature.
- The air venturis should be used sparingly. When open, water temperature drops quite rapidly and can also dissipate chemicals.

Allowing the water temperature to lower more than 10°F below the desired usage temperature and reheating it prior to usage will cause the heater to operate longer than it normally would maintaining the desired temperature. Doing this will increase your operating cost and makes your heater work more than necessary.

### Jets

Almost all of the jets in your spa are adjustable. Rotating the face of an adjustable jet to the left (counter-clockwise) will decrease the amount of water flow through the jet. Rotating the face of an adjustable jet to the right (clockwise) will increase the amount of water flow through the jet. (See example shown below.)

Neck jets adjust in the opposite directions (counter-clockwise to increase, clockwise to decrease).

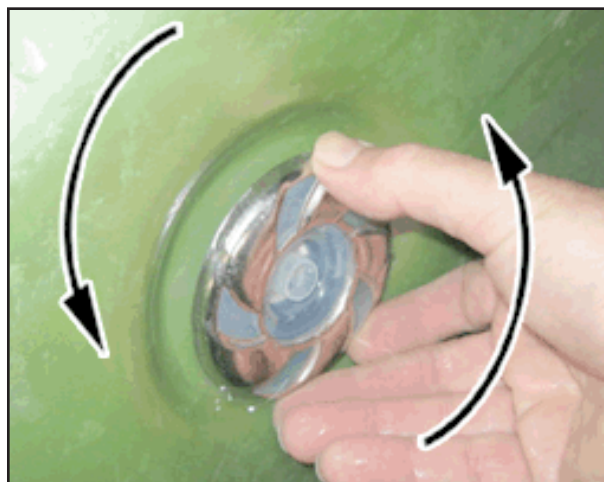

## LED Lighting

Press the LIGHT button on the topside control panel to turn the spa light on. If your spa has perimeter LED lights, they will also light up at the same time as the spa light.

The LEDs operate in three modes:

1. **Cycle:** When you continually press the LIGHT button, the LEDs will cycle through the three main LED colors (Red, Green, and Blue) or combinations of the three that produce the following colors: light green, purple, light blue, yellow, etc.

Each time you press the button, you immediately advance to the next color in sequence or eventually a different light pattern.

2. **Flashing:** When you are cycling through all the colors, the next time you push the LIGHT button, the LED lights may start flashing. This is another normal operational pattern option.

3. **Fading cycle:** The next phase of operation when you push the LIGHT button is a slow and/or fast fade random transition from one color to the next.

Spas with exterior corner LED lighting generally work in the same mode as described above. The variations in color and patterns provide you with multiple options to suit almost any lighting preference.

## Diverter Knobs

Diverter knobs are 1" and 2" knobs located around the top of your spa. They allow you to divert water through jets from one side of the spa to the other, or in most cases from floor jets to wall jets. This is accomplished by rotating the diverter knob to the left (counterclockwise), decreasing the amount of water flow through a section of jets. To increase the amount of water flow through the other section of jets, rotate the handle to the right (clockwise).



## Waterfalls

Some spa series include optional waterfalls. When the booster pump is on, rotate the dial on top (for the cascade waterfall) or turn the knob (for the hydro streamer -- see below).



## Air Venturis

Air venturis are the 1" knobs located around the top of your spa. Each one will let you add a mixture of air with the jet pressure. This is accomplished by rotating the air venturi knob to the left (counterclockwise) to increase the amount of airflow through the jets. To decrease the amount of airflow through the jets, rotate the handle to the right (clockwise).



## Hydro Streamer Waterfall

Your spa may include two to eight streamer waterfalls. When the booster pump is on, turn the 1" diverter knob to adjust the rate of flow to the waterfall jets.

The waterfall jet faces are not adjustable. Do not turn the jet faces because you may accidentally remove them.

Always shut off water to the hydro streamer jets before you place the cover on the spa. Water from the hydro streamer jets sprays in an arc that is higher than the top surface of the spa. When water from the hydro streamer sprays the bottom of the cover, it will collect and run to the edge of the spa and drip over the top.



# Water Clarity

This section is intended for new spa owners with no experience with water chemistry. Everyone’s experience with maintaining water quality is different, but there are some general concepts you need to know.

Water maintenance is not difficult, although it requires regular attention. The most important thing to understand about taking care of your spa water is that preventive action is much easier than correcting water quality issues.

## The Key to Clear Water

Excellent water quality is a simple matter of four things:

### Chemical Balance

You will need to test and adjust the chemical balance of your spa water. Although this is not difficult, it needs to be done regularly.

Depending on your choice of sanitizer, you need to test the level of calcium hardness, total alkalinity, and pH. Spa owners with a Cal Clarity II bromine generator also need to check total dissolved solids and phosphates.

See page 38 to learn how to balance your spa water.

### Sanitation

Sanitizers kill bacteria and viruses and keep the water clean. A low sanitizer level will allow microbes to grow quickly in the spa water. We recommend using either chlorine or bromine as your sanitizer.

Spa owners with an ozonator also need to add sanitizer, although their requirements are different.

See page 38 to learn how to use sanitizer.

### Filtration

Cleaning your filter regularly is the easiest and most effective single thing you can do to keep your water clear.

A clogged or dirty filter will cause the heater and pump to work harder than they need to, possibly causing them to fail.

The spa’s heating system will only function with the proper amount of water flow through the system.

See page 39 for filter cleaning instructions.

### Regularity

Clear water requires regular maintenance. Establish a routine based on a regular schedule for your spa water maintenance.

Maintaining your water quality helps the enjoyment of your spa and extends your spa’s life by preventing damage from neglect and chemical abuse.

See page 40 for the schedule of recommended maintenance.



## Testing and Adjusting Spa Water

You have two types of testing methods to choose from:

- **The reagent test kit** is a method which provides a high level of accuracy. It is available in either liquid or tablet form.
- **Test strips** are a convenient testing method commonly used by spa owners.

## Balancing the Total Alkalinity

Total alkalinity (TA) is the measure of the total levels of carbonates, bicarbonates, hydroxides, and other alkaline substances in the water. TA can be considered a “pH buffer”. It is the measure of the ability of the water to resist changes in pH level.

**The recommended total alkalinity is 80 - 120 ppm.**

If the TA is too low, the pH level will fluctuate widely from high to low. Low TA can be corrected by adding an alkalinity increaser

If the TA is too high, the pH level will tend to be too high and may be difficult to bring down. High TA can be corrected by adding an alkalinity decreaser.

When the TA is balanced, it normally remains stable, although adding water with high or low alkalinity will raise or lower the TA level.

## Balancing the Calcium Hardness

Calcium hardness (CH) is a measure of the total amount of dissolved calcium in the water. Calcium helps control the corrosive nature of the spa’s water and is why soft water is not recommended. The low calcium content of soft water is very corrosive to the equipment and can cause staining of the spa shell.

**The recommended calcium hardness is 150 - 200 ppm.**

If the CH is too low, add a calcium hardness increaser.

If the CH is too high, dilute the spa water with soft water.

When the CH is balanced, it normally remains stable, although adding soft water or very hard water will raise or lower the CH level.

## Balancing the pH

The pH level is the measure of the balance between acidity and alkalinity.

If the pH is too low, it can cause corrosion of metal fixtures and the heating element. Low pH can be corrected by adding a pH increaser.

If the pH is too high, it can cause scaling by allowing metals or minerals to form deposits and stain spa surfaces. High pH can be corrected by adding a pH decreaser.

### Ideal Water Chemistry

Testing For:	Ideal Range (ppm)	
	Minimum	Maximum
Total Alkalinity	80	120
Calcium Hardness	150	200
pH	7.2	7.6

## Sanitation

Sanitizers kill bacteria and other organic waste by breaking them down to non-harmful levels and are filtered out. Before you fill your spa, you need to decide which chemical sanitizer you wish to use. Consult your Cal Spas dealer for the right decision with regards to your lifestyle and spa usage.

We recommend either **bromine** or **chlorine** as your sanitizer. Both work well when maintained regularly.



**DO NOT use trichlor. Trichlor is very acidic and the hot temperature of the spa causes it to dissolve too quickly. It will cause damage to your spa and will void your warranty.**

Whichever plan you decide on, follow it completely and don’t take shortcuts. It will provide you with clean, safe, clear spa water with a minimum of effort. Spa owners with an ozonator still need to use a chemical sanitizer. See page 40 for a description of how the ozonator works.

## Using Chlorine as a Sanitizer

If you choose to use chlorine as a sanitizer, only use granulated chlorine, not liquid chlorine.

Once a week, check the chlorine level using either a test strip or a reagent kit. See the table on the following page for the ideal range. Add one or two tablespoons granulated chlorine to the spa water weekly. Note that chlorine dissipation rate will be faster at higher water temperatures and slower at lower temperatures. When you add chlorine, open all of the jets and run the spa at high speed with the cover open for at least 30 minutes.

Follow the maintenance schedule on page 40.



### Using Bromine as a Sanitizer

Bromine is a very effective sanitizer that produces low chemical odors. Unlike chlorine, it can break down bacteria and other impurities to a safe level with a low burn-out rate.

Use granulated sodium bromide to establish your bromine base.

When you begin with fresh water, add 2 ounces of granulated bromide. Open all of the jets and run the spa at high speed with the cover open for at least 30 minutes.

Follow the maintenance schedule on page 40.

### Bather Load

“Bather Load” is the term used to describe the number of people using a spa, combined with the length of usage, and the frequency of usage. All these factors have a great effect on the spa water. The higher the bather load, the more chemicals need to be added and a longer filtration time will be needed.

Recommendations are designed for spas with average bather load (3 to 4 people, 15 minutes of usage, three times a week at 100 degrees) If your bather load exceeds these guidelines, and you experience water quality problems, increase the amount of filtration first, (go to the next higher filtration number) then if water quality is still not adequate, consult the advice of your Cal Spas dealer for additional chemical or system recommendations. Be sure to give them your bather load information.

### Shocking the Water

In addition to using a chemical sanitizer, you will periodically need to shock the water. Shocking the water helps remove burned-out chemicals, bacteria, and other organic material from your spa’s water and improves your sanitizer’s effectiveness.

Do not use chlorinating shock, which will damage your spa’s jets and pump seals. Only use an oxidizer shock. It can be used with either chlorine or bromine sanitizers.

Add one ounce of oxidizer shock once a week, after heavy bather loads, or if water has a strong odor.

Spa must be running with all of the jets on high for 30 minutes with the cover open. If necessary, repeat oxidizer shock in 30 minute intervals.

Testing For:	Ideal Range (ppm)	
	Minimum	Maximum
<b>Chlorine level</b>		
Without ozonator	3.0	5.0
With ozonator	2.0	4.0
<b>Bromine level</b>		
Without ozonator	6.7	11.0
With ozonator	5.7	10.0

### Filter Cleaning

The filter is the part of your spa that removes the debris from the water and needs to be cleaned on a regular basis to maximize your spa’s filtering performance and heating efficiency.

In addition to spraying off the filter weekly to remove surface debris, your filter should be deep cleaned periodically to dissolve scale and particles that get lodged deep within the filter fibers and impede the filtration process. Even if the filter looks clean, scale and particles can clog the fibers and prevent water from flowing through the filter resulting in the most common spa problem—no heat, caused by a dirty filter. We recommend you clean your filter once a month and replace it once a year or as necessary.

**It is extremely important that you never run the spa without a filter. There is a possibility that debris may be sucked into the plumbing through the filter well.**

**Set the spa in Hold Mode before you remove the filter. Hold Mode pauses all spa operations for 60 minutes for service functions like cleaning or replacing the filter. See page 15 for instructions on using Hold Mode.**

#### Cleaning the filter

1. Remove the filter by unscrewing it and pulling it up and out.

2. Place the dirty filter into a bucket of water deep enough to cover the filter. Add 8 oz of liquid filter cleaner to the bucket of water.  
**Note:** It is a good idea to keep a spare filter to use in the spa while the dirty filter is being deep cleaned. This way, you can rotate the filters and both will last longer.
3. Soak the filter for a minimum of 24 hours.
4. Spray the filter with a water hose. Spray each pleat carefully.
5. Reinstall the filter. Do not overtighten.

## Pure Cure™ Water Sanitizer

The Pure Cure™ water sanitizer is an optional water purification system installed at the factory. It eradicates germs in the water that are resistant to chlorine-based chemicals using high intensity UV light. Although the water sanitizer works automatically with your spa, you will still need to test for chlorine or bromine and occasionally replenish it to return the sanitizer level to the baseline.

For spas without a circulation pump, pump 1 will run at low speed and the water sanitizer will run during filtration. For spas with a circulation pump, the water sanitizer will run with the circulation pump.

The spa's control system is factory-programmed with one filter cycle that will run in the evening when energy rates are often lower. The time and duration of the filter cycle can be set according to your needs. In addition, a second filter cycle can be enabled. Filtration time may need to be increased with heavy bather load. See instructions for setting filtration cycles on page 16.

The water sanitizer is virtually maintenance-free. Once a year the UV light needs to be replaced. See page 45 for instructions. **However, the water sanitizer is not a user-serviceable item and maintenance must be performed by a spa technician. Have your service technician consult the manufacturer's instruction and service manual.**

## Ozonator

The ozone generator releases ozone into the spa water. You will still need to test for chlorine or bromine and occasionally replenish it to return the sanitizer level to the baseline.

For spas without a circulation pump, pump 1 will run at low speed and the ozonator will run during filtration. For spas with a circulation pump, the ozonator will run with the circulation pump.

The spa's control system is factory-programmed with one filter cycle that will run in the evening when energy rates are often lower. The time and duration of the filter cycle can be set according to your needs. In addition, a second filter cycle can be enabled. Filtration time may need to be increased with heavy bather load. See instructions for setting filtration cycles on page 16.

## Maintenance Schedule

<b>Each time you refill the spa</b>	Follow the section "Filling and Powering Up Your Portable Spa" on page 8.
<b>Prior to each use</b>	Test the spa water using either test strips a reagent test kit. Adjust chemical levels as necessary.
<b>Once a week</b>	Test the spa water using either test strips a reagent test kit. Adjust chemical levels as necessary. If your water source is high in calcium, add stain and scale preventer.
<b>Once a month</b>	Deep clean your spa's filter. (Follow filter cleaning instruction at beginning of this section.)

<b>Every two to four months</b>	<p>Change the spa water. How often you change the water depends on how much you use the spa. When you change the water, you will need to:</p> <ul style="list-style-type: none"> <li>• Clean and polish the acrylic surface (see page 45)</li> <li>• Clean and treat the spa cover and pillows (see page 45)</li> <li>• Deep clean the filter (see page 39)</li> <li>• Refill your spa (see page 8)</li> </ul>
<b>Once a year</b>	<p>Replace filter cartridges if the pleats appear frayed.</p> <p>If you use the Cal Pure UV water sanitizer, you will need to replace the UV lamp (see page 45 for UV lamp maintenance)</p>

## Troubleshooting Water Clarity Problems

Problem	Probable Causes	Possible Solutions
Cloudy Water	<ul style="list-style-type: none"> <li>• Dirty filter</li> <li>• Excessive oils / organic matter</li> <li>• Improper sanitization</li> <li>• Suspended particles / organic matter</li> <li>• Overused or old water</li> </ul>	<ul style="list-style-type: none"> <li>• Clean filter</li> <li>• Shock spa with sanitizer</li> <li>• Add sanitizer</li> <li>• Adjust pH and/or alkalinity to recommended range</li> <li>• Run jet pump and clean filter</li> <li>• Drain and refill the spa</li> </ul>
Water Odor	<ul style="list-style-type: none"> <li>• Excessive organics in water</li> <li>• Improper sanitization</li> <li>• Low pH</li> </ul>	<ul style="list-style-type: none"> <li>• Shock spa with sanitizer</li> <li>• Add sanitizer</li> <li>• Adjust pH to recommended range</li> </ul>
Chlorine Odor	<ul style="list-style-type: none"> <li>• Chloramine level too high</li> <li>• Low pH</li> </ul>	<ul style="list-style-type: none"> <li>• Shock spa with sanitizer</li> <li>• Adjust pH to recommended range</li> </ul>
Musty Odor	<ul style="list-style-type: none"> <li>• Bacteria or algae growth</li> </ul>	<ul style="list-style-type: none"> <li>• Shock spa with sanitizer – if problem is visible or persistent, drain, clean and refill the spa</li> </ul>
Organic buildup / scum ring around spa	<ul style="list-style-type: none"> <li>• Buildup of oils and dirt</li> </ul>	<ul style="list-style-type: none"> <li>• Wipe off scum with clean rag – if severe, drain the spa, use a spa surface and tile cleaner to remove the scum and refill the spa</li> </ul>
Algae Growth	<ul style="list-style-type: none"> <li>• High pH</li> <li>• Low sanitizer level</li> </ul>	<ul style="list-style-type: none"> <li>• Shock spa with sanitizer and adjust pH</li> <li>• Shock spa with sanitizer and maintain sanitizer level</li> </ul>
Eye Irritation	<ul style="list-style-type: none"> <li>• Low pH</li> <li>• Low sanitizer level</li> </ul>	<ul style="list-style-type: none"> <li>• Adjust pH</li> <li>• Shock spa with sanitizer and maintain sanitizer level</li> </ul>
Skin Irritation / Rash	<ul style="list-style-type: none"> <li>• Unsanitary water</li> <li>• Free chlorine level above 5 ppm</li> </ul>	<ul style="list-style-type: none"> <li>• Shock spa with sanitizer and maintain sanitizer level</li> <li>• Allow free chlorine level to drop below 5 ppm before spa use</li> </ul>
Stains	<ul style="list-style-type: none"> <li>• Total alkalinity and/or pH too low</li> <li>• High iron or copper in source water</li> </ul>	<ul style="list-style-type: none"> <li>• Adjust total alkalinity and/or pH</li> <li>• Use a stain and scale inhibitor</li> </ul>
Scale	<ul style="list-style-type: none"> <li>• High calcium content in water – total alkalinity and pH too high</li> </ul>	<ul style="list-style-type: none"> <li>• Adjust total alkalinity and pH – if scale requires removal, drain the spa, scrub off the scale, refill the spa and balance the water</li> <li>• Use a stain and scale inhibitor</li> </ul>

## Cleaning and Maintenance

### Removing and Reseating the Pillows

You can remove the pillows for cleaning and maintenance quickly and easily. This method works for all types of pillows.

Grab the lower edge of the pillow with both hands firmly and pull up. As you do this, the pillow inserts will pop out of the holes.

Reseat the pillows by aligning the pillow inserts with the holes and striking the pillow hard enough to insert the pegs back into the holes.

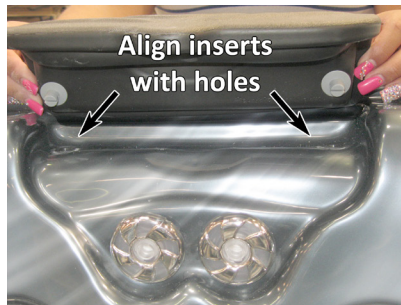

### Jet Remove/Replace

Jets can be easily removed for cleaning.

Grasp the outer rim of the jet and turn it counter-clockwise. The jet will unscrew from the fitting until it is free.

To replace the jet, place it in the fitting and turn it clockwise until it is snug in place. Do not overtighten the jet.

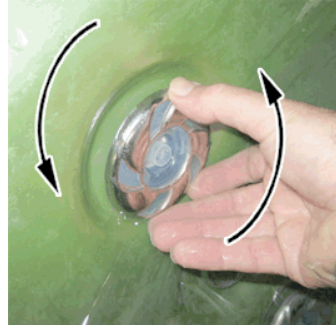

### Spa Cover

Important! Keep the spa covered when not in use!

- Covered spas will use less electricity in maintaining your set temperature.
- Covering your spa will protect your spa's finish from the sun's ultraviolet rays.
- You are required to keep the spa covered to maintain warranty coverage.
- Covering your spa helps prevent children from drowning in the spa.

See the manual enclosed with your cover for instructions on mounting the locks and how to lock and unlock the cover.

In addition, while the spa cover is rigid, it is not designed to support any weight. Therefore, as a safety precaution and to preserve the life of your cover, you must not sit, stand, or lie on it, nor should you place objects of any kind on top of it.

## Draining Your Portable Spa

Your spa should be drained every four to six months for cleaning and maintenance and refilled with fresh tap water. See page 45 for instructions on cleaning the shell, cover, and pillows. See page 8 for instructions on refilling your spa. Before you begin, turn off power to the spa at the breaker and remove all filters.

### 1. Locate your drain.

#### *For spas with drain inside the spa*

Using a Phillips screwdriver, remove the screws to the access panel and open it. Locate hose ending with the 3/4 inch hose-bib fixture as shown below.



#### *For spas with cabinet mounted drain*

Pull the knob out of the cabinet. The cabinet drain is screwed into the drain pull knob.



### 2. Remove the cap

Make sure the valve is in the closed position, then unscrew and remove the cap. Unscrew the cap.

#### *For spas with drain inside the spa*

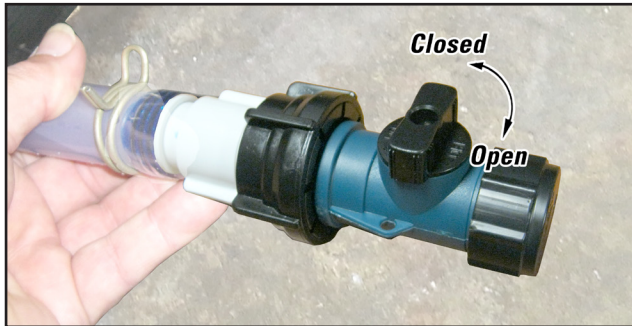

#### *For spas with cabinet mounted drains*



### 3. Connect valve to a garden hose.

Attach a garden hose to the hose-bib fixture. Place the other end of the garden hose where you would like the water to drain.

### 4. Drain the spa.

Turn the valve on the hose-bib fixture to open the drain. When the spa has drained completely, turn the valve on the hose-bib fixture, remove garden hose, and replace the cap.

#### *For all spas*

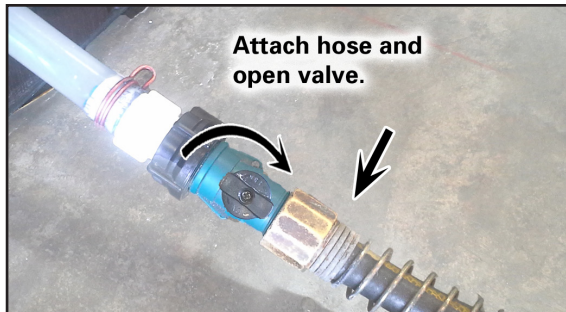

## Winterizing (Cold Climate Draining)

In many areas of the country, the temperature drops below 32°F (0°C). We recommend that you always have your spa full of water and running at normal spa temperatures (80°F to 100°F, 26.7°C to 37.8°C). This will help reduce the risk of freezing in your spa and your spa's equipment.

**Warning: If you find the need to drain your spa, be aware of the potential of freezing in your spas equipment and plumbing. Even if the directions below are followed perfectly, there is no guarantee that your spa will not suffer freeze damage. Freeze damage is not covered by your warranty.**

1. Open all filter covers.
2. Remove the filter baskets and filters.
3. Drain your spa completely as described in the instructions above.
4. Vacuum water from the spa's main drain fitting with a wet/dry vacuum.
5. Open the bleeder valves on the pumps.
6. For spas with the UV lamp chamber mounted flat on the equipment floor:  
Loosen the quartz tube nut at the top of the UV lamp chamber and pull up the quartz tube to let the water drain from the UV lamp chamber.
7. Disconnect the unions from both sides of the pump.
8. Blow any remaining water out of the jets and equipment area with the wet/dry vacuum.
9. When it has completely finished draining, replace the quartz tube in the UV lamp chamber and retighten the nut. Close the bleeder valves and re-connect the unions on the pumps. Replace the filter baskets and filters.
10. Cover your spa with a good spa cover and an all-weather tarp to ensure that neither rain nor snow enters the spa.

## Cleaning and Replacing the Filter

Filtration is one of the most important steps you can take to ensure clean, clear water. It is far less expensive to fix water clarity problems by filtering your spa than by using excessive amounts of chemicals, excessive filtration times, or by water replacement.

See the section "Filter Cleaning" on page 39 for more information.

## Vacation Care

You can leave your spa unattended for up to two weeks if you follow these instructions.

***ALWAYS lock your cover using the cover locks if you plan to be away from home and the spa is filled with water.***

1. Select the Low Range temp choice used for vacation mode. (See instructions on page 13 for vacation setting.)
2. Following the water quality instructions starting on page 37, adjust the pH.
3. Shock the water (add either chlorine or bromine sanitizer).
4. When you return, check and adjust the pH and shock the water.

If you will not be using your spa for longer than 14 days and a spa maintenance service is not available, we strongly recommend you drain or winterize your spa.

# Cleaning Your Spa

## Spa Cover and Pillows

Due to the constant punishment your spa cover and pillows receive, you should protect them by applying a vinyl and leather cleaner as part of your monthly maintenance plan. Use a product that is specifically designed to protect spa covers and pillows from chemical and ultraviolet light damage without leaving an oily residue behind that is normally associated with common automotive vinyl protectants.

**Warning: Do not** use automotive vinyl protectants on spa covers or pillows. These products are generally oil-based and will cause severe water clarity issues that are difficult to correct.

## Spa Shell

Each time you drain your spa, before you refill it you should clean your spa shell with an all-purpose cleaner and apply a coat of surface protectant.

Use a low detergent, non-abrasive cleaner specifically formulated to clean the spa without damaging its acrylic finish.

Use a non-oil based surface protectant that is specifically formulated to protect the spa's finish from the chemicals and minerals associated with normal spa use.

# Changing the UV Lamp

**CAUTION: Always turn off power to the spa at the GFCI prior to any maintenance.**

Note: Periodically you should check the light on the transformer for the UV light system. The transformer is mounted in the spa equipment area close to the system control box. When it is operating normally, the light will be green. When it requires maintenance, it will be red. This usually happens when the UV lamp needs replacing. The UV lamp is a wearable part that needs replacing about once a year.



### To remove the UV lamp

1. Disconnect power.
2. Turn water off and open down stream of system to relieve pressure.
3. Cut the tie wrap that attaches the UV lamp chamber to the spa frame.
4. Remove the water-proof strainer (1) and unscrew the aluminum nut (2).
5. Pull out the lamp (4) approximately 2" from the chamber (7).
6. While holding the lamp end, remove the lamp socket (3) from the end now exposed.
7. Remove the lamp from the chamber.
8. Remove the O-ring (5) from the end of the quartz thimble (6).
9. Remove the quartz thimble.

1	Water-proof strainer
2	Aluminum nut
3	Lamp socket and lead wire
4	Germicidal UV lamp
5	Rubber O-ring
6	Quartz thimble
7	Chamber
8	Clip
9	Ballast

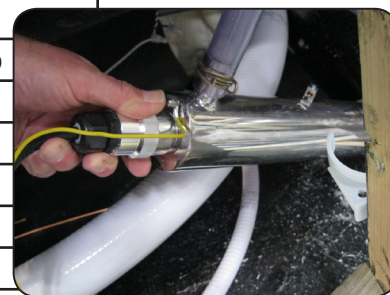

To reinstall the replacement UV lamp, follow these steps in reverse.

When replacement UV lamp has been installed, conduct a final leak check:

1. Restore power to the spa at the GFCI.
2. Turn on the pump and let water run for five minutes to check for leaks.

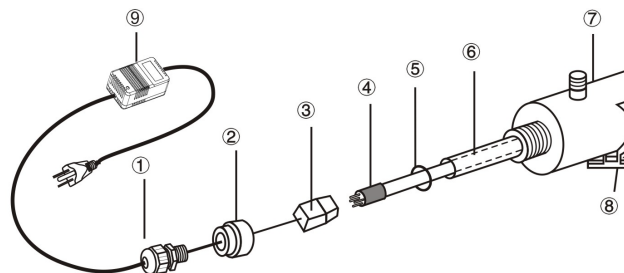

## Using the Digital Media Locker



The Aquatic AV digital media locker is fully integrated with your Cal Spa. It will accommodate any digital device, such as iPhones, smart phones, and MP3 players, that is USB or Bluetooth capable.

The docking station comes with its own owner's manual. It describes parts included, installation, and proper use. Owners of this system must read the manufacturer's instructions prior to operating this unit. The instructions are shipped inside the docking station behind the remote control.

The instructions contained in this manual describe only basic functions. See the manufacturer's operating instructions for other features and functions.

Although the media locker features a locking door with seals, it is **water resistant** and **NOT waterproof**. You must take every precaution to keep the interior of the media locker dry.

- Make sure that hands are dry before coming in contact with the media locker.
- Always CLOSE AND LOCK the protective door.

See this page for instructions on protecting the media locker from water damage. **Water damage caused by negligence or improper use is not covered under warranty.**

**Note: The digital media locker comes with a remote control and does NOT INCLUDE an MP3 player such as an iPod.**

### Aquatic AV AQ-DM-5UBT Media Locker

#### Synchronizing (Pairing) the Remote Control with the Media Locker

Before you can use the remote control with the docking station, they need to be synchronized, or paired. Follow the simple instructions below.

1 Before you begin, make sure the docking bay is **OFF**. If the red **Power** light inside the docking bay is on, press it once to turn it off.



2 Press the red **Power** button on the remote.



3 Press and hold the **Mode** button on the remote. The display on the remote will read **PAIR**.

4 While still holding the **Mode** button, press and hold the **Power** button inside the docking station for **five seconds**.

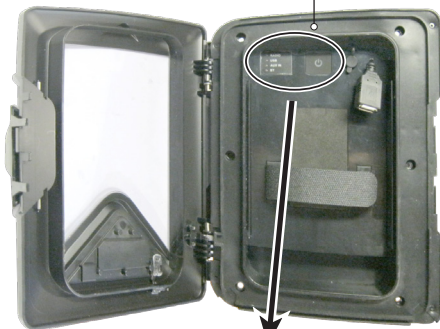

The display on the remote will read **WELCOME** or show a mode position such as **RADIO**.



When the remote and docking bay are paired, the power button light will turn blue.

If they do not pair the first time, repeat these four steps until it is successful.

The media locker shown in this instruction is model AQ-DM-5UBT, although this pairing instruction can be used with earlier Aquatic AV media lockers that use a remote control. Model AQ-DM-3B does not require a remote and does not need to be paired in order to function.



#### If you have trouble pairing the devices:

- Re-read the instructions and follow them carefully. You may have missed an important detail.
- Make sure the red power light inside the docking bay is OFF before you begin.
- PRESS and HOLD the **Mode** button on the remote until it reads PAIR. Do not release the **Mode** button. Do not press the **Power** button inside the docking station until the remote reads PAIR.
- Press and hold the **Power** button for NO MORE than five seconds. Otherwise, the devices will not pair.



## Listening to Devices

There are three ways to connect your device to the media locker: With the USB connection, Bluetooth connection, and the auxiliary input.

### 1. Connecting via USB

The Aquatic AV digital media locker comes with one USB connector for Apple devices. If you have another kind of device, you will need to supply your own USB connector, such as the type shown below.



Apple USB connector



USB micro B connector

1. Attach your device to the USB cable inside the digital media locker using the appropriate USB connector.
2. Secure the device with the anchor straps.
3. Close and lock the media locker's protective door.
4. Press **POWER** on the remote control or Power button on the locker to turn it ON.
5. Press **MODE** on the remote control to select USB mode. Use the buttons as shown in the remote function chart.

**Note: When USB devices are connected to the USB input, the device's battery will charge.**

#### Search for Songs and Playlists

##### Apple devices

1. Press **SEARCH** to enter iPod searching mode.
2. Once in searching mode, the remote will display 'Playlist'. Continue to press **SEARCH** to scroll through the search modes below:
  - 1) Playlist 2) Artist 3) Album 4) Song 5) Genre 6) Composer 7) Audio Book
3. Press **PLAY/PAUSE** To select the desired search mode.
4. Press **Volume UP/DOWN** to scroll through your media in the selected search mode.
5. Once you find the desired media, press **PLAY/PAUSE** to make your selection. If your selection is a song, it will begin to play. If you select a playlist,

artist, album, genre, composer or audio book, the songs in the selected folder will be visible. Press **PLAY/PAUSE** to play the desired song within the folder.

##### Other USB devices

1. Press **SEARCH** to enter the USB searching mode.
2. Press **Volume UP/DOWN** to scroll through the folders on your USB device. To select a folder, press the **PLAY/PAUSE** button.
3. Press **Volume UP/DOWN** to scroll through the songs in the folder and press **PLAY/PAUSE** to play the desired song.

### 2. Connecting via Bluetooth

1. Switch on your Bluetooth device.
2. Select 'AQUATIC AV' from the list of available devices to pair (no password is needed).

Only one Bluetooth device can be paired with the Digital Media Locker at any time.

Bluetooth mode will be activated once a Bluetooth device is linked. Play the song from device and the sound will play through the Digital Media Locker.

- Press **PLAY/PAUSE** to play or pause the song.
- Press **FAST REWIND** or **FORWARD** buttons to play previous/next song file.

Track and volume can be controlled directly from your Bluetooth device, remote control or door controls.

### 3. Connecting via Auxiliary Input

When you connect your device via the auxiliary input, you play media directly to the audio input of the media locker. The remote control can not control your device when it is connected through the auxiliary input. You will need a 3.5 mm audio connector as shown below.



1. Connect your MP3 device to the 3.5 mm jack input.
2. Secure the device with the anchor straps.
3. Close and lock the media locker's protective door.
4. Press **POWER** on the remote control or the **POWER** button on the locker to turn it ON.
5. Press **MODE** on the remote control to select 'AUX IN' mode.

Only one auxiliary input (3.5 mm jack) can be used at any one time.

### Listening to FM Radio

Press **MODE** on remote control to switch to FM radio mode. If this is the first time you listen to FM radio, the default frequency will be 87.5MHz, as shown on the remote LCD.

To scan or seek FM radio channels, press **FAST REWIND** or **FAST FORWARD** to seek another station. Press and hold either **FAST REWIND** or **FAST FORWARD** for manual tuning back or forward.

To save the current radio station into memory, press and hold the **1**, **2**, or **3** button for more than 2 seconds. The station will be stored to that button. Press the **1**, **2**, or **3** button to listen to the preset station.

## Remote and Keypad Functions

All of the functions on remote control and the keypad on the media locker's door are identical. For a detailed description of all key functions, see the manual for the Aquatic AV media locker.



## Closing and Locking the Door

Always CLOSE and LOCK the media locker door after you place or remove a media device inside it.

Slide the clasp down to lock the door as shown at right. Make sure the door is firmly pressed into the watertight seal before you slide the lock into place.

**Water damage caused by negligence or improper use is not covered under warranty.**



## Using the Freedom Sound System

The Freedom Sound System™ entertainment option contains a Bluetooth-enabled speaker system that is available for certain Cal Spa models. Any Bluetooth-enabled device can be used to play audio through your spa.

Before you can use the sound system, you need to pair the Bluetooth module with your device. The Bluetooth module is installed within the spa cabinet. Everything can be done with your device. The example shown below is from an iPhone device. Your device may appear differently. Before you begin, make sure Bluetooth is enabled on your device.

1. Select Bluetooth from your device's option list.
2. Select **SWA8-1BT...** from the list of available devices to pair.
3. Allow your device to pair with the spa's Bluetooth module.
4. When the devices have been connected, the device **SWA8-1BT...** will be highlighted.

Only one Bluetooth device can be paired with the Freedom Sound System™ at any time.

Once your device is paired and connected, all sounds from your device will be played through the sound system, including system sounds and telephone.

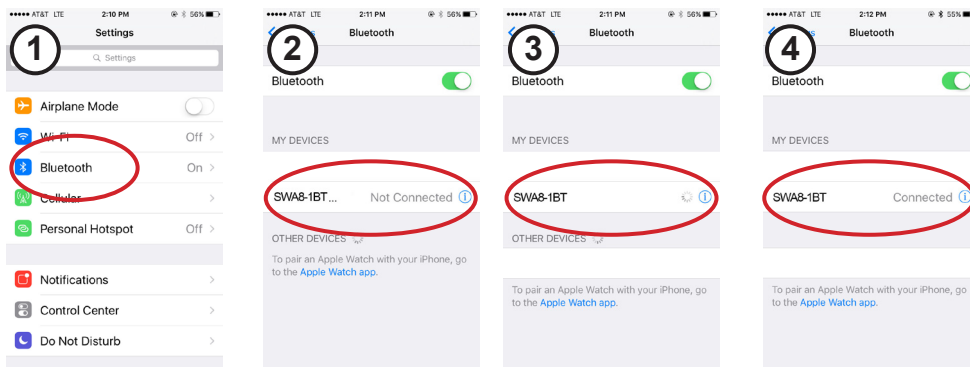

# Keeping Fit With Your Swim Spa

## Jetstream Propulsion System

Use the control panel to start and stop the Jetstream Propulsion System. The **JETS1** and **JETS2** buttons control the top and bottom jets.

Use the air venturi valves to inject air in the water streams.

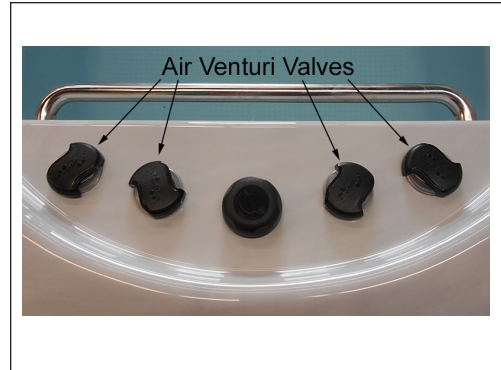

## Swim Tether

The swim tether pole has three pieces and assembles easily. Slide the ends of the top and middle sections into the middle and bottom sections.

Insert the tether in the anchor hole when you are ready to use it.

Buckle the strap around your waist. It is easily adjustable and can accommodate most sizes.



## Exercise Equipment

**IMPORTANT:** Always consult your physician before starting any exercise activity or program. The Ultimate Fitness series spas feature rubber exercise bands. When stretched, these bands create a high tension condition. Improper use or failure to connect the exercise bands properly may cause injury. Always inspect all of the exercise equipment prior to beginning any exercise. Do not use any damaged equipment.

This equipment attaches to the exercise anchors located on the spa walls.

### Connecting the Exercise Equipment

The drawings below show different ways the exercise kit can be connected depending on the exercises you wish to do.

#### For 14 foot spas and model F1222

The exercise kit contains:

- Two hand grips
- Two ankle braces
- Two 6" elastic bands
- Two 18" elastic bands
- Two 25" elastic bands
- Two rowing bars

#### For 16 and 17 foot spas

The exercise kit contains:

- Two hand grips
- Two ankle braces
- Two 18" elastic bands
- Two 25" elastic bands
- Two 56" elastic bands
- Two rowing bars

When attaching the rowing bar, place the hook into the eye pad as shown.

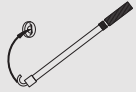

Elastic bands attach to the eye pad as shown.

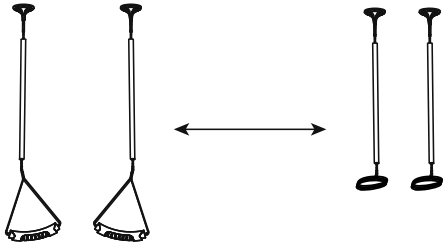
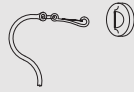

All elastic bands can be connected to either end of the spa and used with hand grips or ankle braces.

**Typical configuration for F1222 spa**

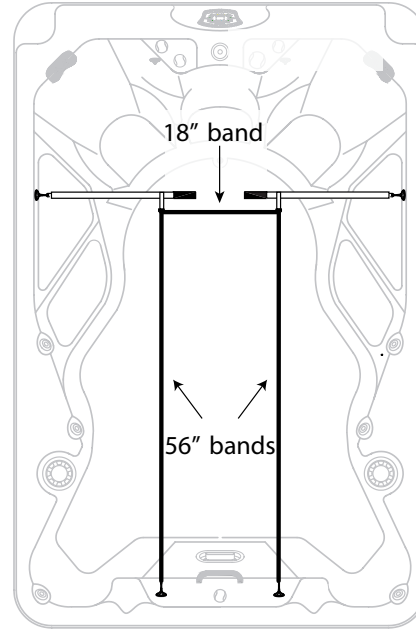

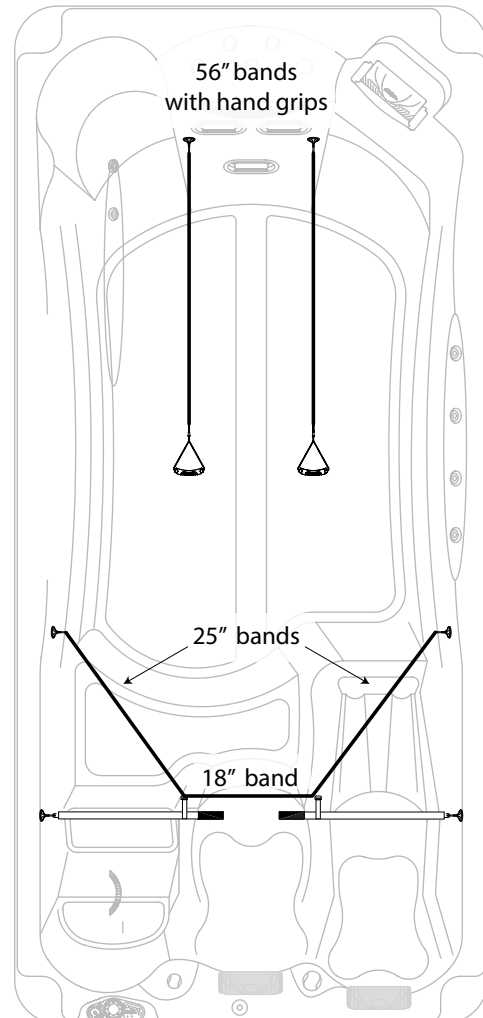

**Typical configuration for 16' and 17' spa**

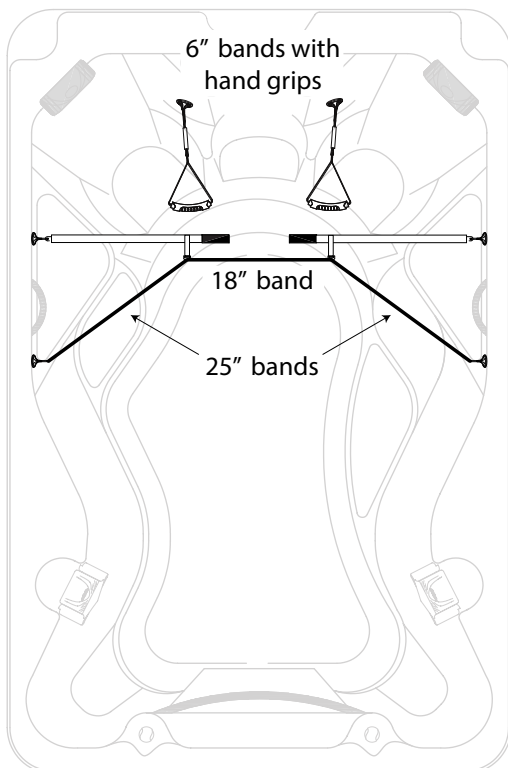

**Typical configuration for 12', 13', 14' spa**

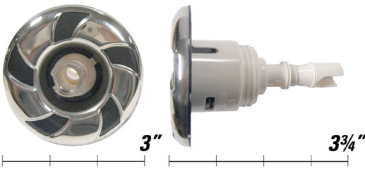
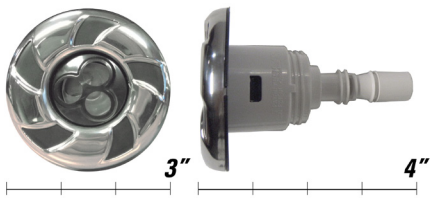
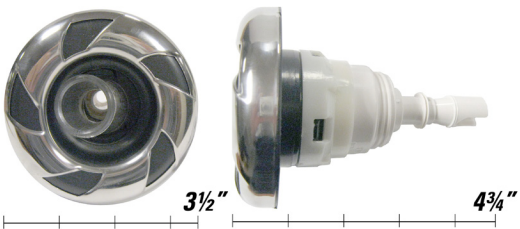

## Replacement Parts

Jets Inserts - Screw-in	
<p><b>ELE 2" Euro No Eyeball</b> PLUCS2295021SL</p> 	
<p><b>MED 3" XL Cluster Storm Directional</b> PLUCS2295031SL</p> 	
<p><b>mfd 3" Micro Flow Directional</b> PLUCS2295061SL</p> 	
<p><b>MM 3" Mini Storm Massage</b> PLUCS2297061SL-8</p> 	
<p><b>MFD 3.5" Maxi Flow Directional</b> PLUCS2295091SL</p> 	

Jets Inserts - Screw-in	
<p><b>PSD 5" Power Storm</b> PLUCS2295131SL</p> 	
<p><b>PSR 5" Power Storm Riffed</b> PLUCS2295141SL</p> 	
<p><b>PST 5" Power Storm Wagon Wheel</b> PLUCS2295191SL</p> 	
<p><b>River Jet Assembly Black with Stainless Steel Rim 210-5101SCS</b> PLU210-5101SCS</p> 	

Please visit [www.quickspaparts.com](http://www.quickspaparts.com) to order your replacement parts.

**Jets Inserts - Snap-in SQR**

**SQN candy cane, 2" neck jet, 100% shut-off**  
**Candy cane w/clear center**  
 PLU29923-144-000

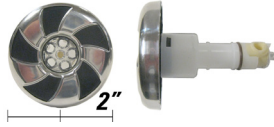

**Waterfall**

**SQL, SQR dual hydrostream (#25269-404-000) - includes jet insert, jet body, gasket and nut**  
 PLU25269-404-000



**Pillows**

**Cascade Pillow No Insert Black**  
 ACC01401031



**Infinity Pillow Ribbed Black**  
 ACC01401051



**Infinity Pillow Plain Black**  
 ACC01401061



**Water Diverter Valves**

**Diverter Valve 2" Black/Titanium**  
 PLU21300465



**Diverter Valve 1" Black/Titanium**  
 PLU21300453



**Water Diverter Valves**

**Diverter Valve 1 1/2" On/Off ASSY (600-4601)**  
 PLU21100045



**Air Control Valve**

**Air Control Black/Titanium**



**Drains**

**Drain Super Hi Flo Suction 2 1/2" Black (640-3581LGV)**  
 PLU21400146



**Low Profile Drain 3/4" Black (640-0511)**  
 PLU21400401



**Teleweir Skimmer**

**Teleweir filter skimmer 50 sq. ft. (510-4601)**  
 FIL11700006



**Filter**

**50 sq ft female threaded - antibacterial (for Teleweir skimmer shown above)**  
 FIL50-5D15H15FCT-3



**LED Lights**







**1-LED light string**  
 LIT16100330









**2-LED light string**  
 LIT16100331



Please visit [www.quickspaparts.com](http://www.quickspaparts.com) to order your replacement parts.

LED Lights	
<b>4-LED light string</b> LIT16100332	
<b>1 to 3 ext. cord</b> LIT16100335	
<b>1 to 1 port ext. cord</b> LIT16100338	
<b>Interior light with logic (7 LED)</b> LIT16100333	
<b>Interior light without logic (7 LED)</b> LIT16100337	
<b>Main light housing, LED lens, fitting nut</b> LIT16100336	

Pure Cure™ UV Water Sanitizer	
<b>Pure Cure complete system (Wonder PP-1)</b> LIT16000380	
<b>Germicidal UV lamp (T515)</b> LIT16000381	
<b>Rubber O-ring (D24.5)</b> LIT16000384	
<b>Quartz thimble (24.5X350)</b> LIT16000383	
<b>Ballast (UV-3)</b> LIT16000382	

Pure Cure™ UV Water Sanitizer	
<b>Clips</b> LIT16000385	
<b>Main Light Without Logic</b> LIT16100629	

Exercise Equipment	
<b>Exercise Kit for 7 Foot and 8 Foot Spas</b> EXC12000006	
<b>Exercise Kit for 11 Foot Spas</b> EXC12000005	
<b>Exercise Kit for 12 Foot and 14 Foot Spas</b> EXC12000008	
<b>Exercise Kit for 16 Foot and 17 Foot Spas</b> EXC12000007	
<b>Exercise Kit Attachment Plate</b> EXC11000065	

**Replacement Cabinet Panels**  
 The complete selection of replacement cabinets for all models is very extensive and too lengthy for this owner's manual. To order replacement panels for your spa, visit [www.quickspaparts.com](http://www.quickspaparts.com).

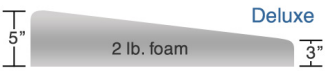
Covers	
All spa covers are designed with a tapered height, angling downward from the center to the sides to drive off rain and prevent water from pooling. The covers listed below are filled with either 1 lb, 1.5 lb, or 2.0 lb foam.	
<b>Deluxe</b> 5" - 3" 2.0 Lb. foam	

- 93" x 141"**  
Fits spa models: F-1222
- 93" x 171"**  
Fits spa models: F-1420, F-1437
- 93" x 200"**  
Fits spa models: F1640, F-1770
- 93" x 151"**  
Fits spa model 1335

- Deluxe**
- Gray** COV93151D53G-CC
- Slate** COV93151D53S-WN

Please visit [www.quickspaparts.com](http://www.quickspaparts.com) to order your replacement parts.

## Basic Troubleshooting

The troubleshooting guidance provided here is intended to cover the most common problems a spa owner may encounter. For more in-depth troubleshooting, go to [www.calspas.com/troubleshooting](http://www.calspas.com/troubleshooting).

Symptom	Possible Solutions
<b>Problems starting up</b>	
Pump won't prime	See priming instructions on page 10.
Breaker keeps shutting off	Reset the GFCI breaker. If this continues, contact your dealer or a qualified spa technician.
<b>Power and system problems</b>	
System won't start up or breaker keeps shutting off	Power may be shut off. Turn on GFCI circuit breaker. If this continues, contact your dealer or a qualified spa technician.
Control panel doesn't respond	Turn on or reset the GFCI circuit breaker. If this does not solve the problem, contact your dealer or a qualified spa technician.  If you hear the pump running but the control panel doesn't respond, contact your dealer
Spa does not turn off	Spa may be trying to heat up. Check if spa is in Ready or Rest mode (see page 14).  In cold climates, if spa is not equipped with full foam or any kind of insulation, it will try to maintain the set temperature. Set the spa to low temperature range and set the temperature to 80°F.  Spa may be in filter cycle. If it is, this is normal and no adjustment is necessary.
Message on the control panel	There may be a problem. See Diagnostic Messages on page 18.
<b>Heat problems</b>	
Spa water does not get hot	Spa may be in low temperature range. Set the spa to high temperature range.  The filter may be dirty or may need to be replaced. Clean or replace the filter.  The water level may be too low. Fill the spa with water level at 4 to 6 inches from the top.  The temperature is not turned up high enough. Raise temperature on topside control.  Cover the spa. The cover will keep heat in the spa and help keep heat from escaping. Make sure cover is on at all times when spa is not in use.  The heater element may be old, deteriorated, coated with scale, or defective. Contact your dealer for more assistance.  The gate valves may be partially or completely closed. NEVER OPERATE YOUR SPA WITH THE GATE VALVES CLOSED!
Spa overheats - temperature greater than 110°F / 43°C	Overheating can occur during summer months and may not necessarily indicate a malfunction. When it occurs, a message code may also appear on the control panel.  Temperature may be set too high. Turn the set temperature down to a lower temperature.  Filtration time may be too long. Turn the filtration cycles down during the warm months.  The spa may not be properly ventilated. Make sure the front of the spa is not blocked to allow air flow.  High speed pumps may have been running too long. Limit pump running time to no more than 15 to 30 minutes.



Symptom	Possible Solutions
---------	--------------------

**Water pressure problems**

Low water pressure	<p>Jet valves may be partially or fully closed. Open the jet valves.</p> <p>Filter cartridge may be dirty. Clean or replace the filter.</p> <p>Pump may have airlock. Remove airlock by priming spa (page 10)</p> <p>The suction fittings may be blocked. Remove any debris that may be blocking them.</p> <p>The filter skimmer may be blocked. Remove the blockage.</p> <p>Gate valves may be closed. Open gate valves. Note: Never operate your spa with the gate valves closed!</p> <p>Spa may be running in filtration mode. Press JETS or JETS 1 button to turn on high speed pump.</p>
No water pressure (no water stream from any jets)	<p>Power may be switched off. Turn the power back on.</p> <p>The pump may be defective. After you have tried all other troubleshooting, contact your dealer for assistance.</p>
Jets surge on and off	<p>Water level may be too low. Add water to normal level.</p>

**Pump problems**

Pump runs constantly – will not shut off	<p>There may be a problem with circuit board. Contact your dealer.</p>
Noisy pump	<p>The water level may be too low. Fill the spa with water level at 4 to 6 inches from the top.</p> <p>Filter cartridge may be dirty. Clean or replace the filter.</p> <p>Pump may have airlock. Remove airlock by priming spa (page 10)</p> <p>The suction fittings may be blocked. Remove any debris that may be blocking the suction fittings.</p> <p>Gate valves may be closed. Open gate valves. Note: Never operate your spa with the gate valves closed!</p> <p>Air may be leaking into the suction line. Contact your dealer for assistance.</p> <p>Debris may be inside the pump. Contact your dealer for assistance.</p> <p>Noise may be a sign of damage. Contact your dealer for service.</p>
Pump turns off during operation	<p>Automatic timer may have completed its cycle. Press JETS or JETS 1 button to start the cycle again.</p> <p>Pump may have overheated due to the vents on the equipment door being blocked. Make sure the front of the spa is not blocked to allow air flow.</p> <p>The pump motor may be defective. Contact your dealer for assistance.</p>
Pump has a burning smell while running	<p>A burning smell may be a sign of damage. Contact your dealer for service.</p>
Pump does not run	<p>Pump may have over heated. Let it cool for an hour and try operating the spa for a shorter time.</p> <p>Power to the spa may be shut off. Turn on or reset the GFCI circuit breaker. If this does not solve the problem, contact your dealer or a qualified spa technician.</p>

# LIMITED WARRANTY

This Limited Warranty is extended to the original purchaser of a Cal Spa brand portable spa manufactured after January 1, 2017 and installed for residential use in the United States of America and Canada. This warranty begins on the date of delivery of the spa, but in no event later than one year from the date of manufacture.

## Shell Structural

Warranted against water loss due to defects in the spa shell.

10 years

## Shell Finish

Warranted against blistering, cracking, or delaminating of the interior surface of the spa shell.

7 years

## Equipment and Controls

Electrical equipment components – specifically limited to the pumps, standard titanium heater, and control system – are warranted against malfunctions due to defects in workmanship or materials.

5 years

## Plumbing

Warranted against leaks due to defects in workmanship or materials.

5 years

## Cabinet - synthetic, fiberglass, or wicker

Warranted against defects in workmanship or materials. Normal wear and weathering of the finish will occur naturally over time and are not defects.

5 years

## Warranties for Other Components

The fuses, headrests, cabinet finish, and filters are warranted to be free of defects in workmanship and material at the time of delivery. The factory installed water purification system is warranted against malfunction due to defects in workmanship or material for one year from the original date of delivery, except for the UV bulb and quartz tube, which are warranted for 90 days from the original date of the spa delivery. All stereo-related components (receiver, speakers, sub-woofer, stereo media locker, power supply, wireless remote control etc.) are warranted against malfunction due to defects in workmanship or material for one year from the original date of delivery. All other factory-installed components not mentioned specifically, including, but not limited to the wood frame, jets, diverter valves, LED lighting systems, filter lids, and mechanical components, are warranted against malfunction due to defects in workmanship and material for two years from the original date of delivery. The spa cover delivered with the spa is warranted for one year for Escape, Platinum, Fitness, and Special Edition spas, 90 days for Zone, Connect, and New Age spas.

## Genuine Cal Spas Parts & Accessories

This Limited Warranty is void if Cal Spas (the "Manufacturer") or its designated representative determines that the spa has been subjected to damage or failure due to installation of aftermarket parts that are not genuine Cal Spas branded parts and accessories. This disclaimer includes, but is not limited to filters, UV bulbs, ozone systems, salt systems, repair parts and other accessories. Genuine Cal Spas brand parts and accessories are built to our highest standards of quality, durability and performance, and they are designed to work with your spa to ensure optimal performance and function.

## Performance

This warranty begins on the date of delivery of the spa, but in no event later than one year from the date of manufacture.

To obtain service in the event of a defect covered by this Limited Warranty, notify your Cal Spa dealer or Cal Spas as soon as possible and use all reasonable means to protect the spa from further damage. Upon proof of purchase, a designated service representative will correct the defect subject to the terms and conditions contained in this Limited Warranty. There will be no charge for parts or labor to repair the defect, although providing access to affect the repair is your responsibility as the spa owner. Freight charges for replacement parts is the responsibility of the spa owner. You may be assessed reasonable repairman travel mileage charges.

In the event that the spa is removed to a repair facility for repair and reinstalled, the cost of removal and reinstallation will be your responsibility as the spa owner. If the Manufacturer determines that repair of the covered defect is not feasible, it reserves the right to provide a replacement spa instead, equal in value to the purchase price of the original spa. In such an event, reasonable costs for removal of the original spa, shipping costs from the factory for the replacement spa and delivery and installation of the replacement will be your responsibility as the spa owner. The replacement spa will carry the balance of the original spa's warranty. Spa covers are not included.

This warranty ends either by specified time frame, owner-transfer, relocation, or installation of any component other than by manufacturer.

### **Warranty Limitations**

This Limited Warranty is void if Cal Spas or its designated representative determines that the spa has been subjected to alteration, neglect, misuse or abuse, or freight damage caused by the common carrier; any repairs have been attempted by anyone other than a designated representative; the failure is caused by accident, acts of God or other causes beyond the control of the Manufacturer; neglect, misuse and abuse include any installation, operation or maintenance of the spa other than in accordance with the instructions contained in the owner's manual provided with the spa, including but not limited to the failure to maintain proper water chemistry and chemical balance and the use of abrasive or improper cleaners or non-genuine parts and accessories. This Limited Warranty does not provide coverage for any item attached to or installed on the spa after the date of manufacture or for gaining access to any component for repair or replacement. Spa units in commercial use are excluded from any coverage whatsoever. The spa owner accepts liability for repair work performed by anyone other than the Manufacturer or a designated Cal Spa representative.

### **Limitations**

The Manufacturer disclaims all warranties, expressed or implied, in fact or in law, to the extent allowed by your State's Law, including the warranty of merchantability and fitness for use, except as stated specifically herein. All warranty service must be performed by the Manufacturer or its designated representative using authorized Cal Spa parts. No agent, dealer, distributor, service company or other party is authorized to change, modify or extend the terms of this limited warranty in any manner whatsoever. The Manufacturer will not be responsible for any statements or representations made in any form that go beyond, are broader than, or are inconsistent with any authorized literature or specifications furnished by Cal Spas.

### **Disclaimers**

The Manufacturer and its representatives shall not be liable for any injury, loss, cost or other damage, whether incidental or consequential, arising out of any defect covered by this limited warranty, including without limitation, loss of use of the spa and cost for removal of defective product even if the Manufacturer was advised of the possibility of damage. The liability of the Manufacturer under this limited warranty, if any, shall not exceed the original amount paid for the defective product. Coverage under this limited warranty shall commence as of the original date of delivery and the duration of such coverage shall not extend for any reason whatsoever beyond the stated time periods. These disclaimers shall be equally applicable to any service provided by the Manufacturer and its designated representatives.

### **Legal Rights**

This Limited Warranty gives you specific legal rights. You may also have other rights that vary from state to state. Some states do not allow limitations on how long an implied warranty lasts, so this limitation may not apply to you.

Please visit [www.quickspaparts.com](http://www.quickspaparts.com)  
to order your replacement parts.

### Locating the product serial number

The serial number of your spa is located on a metal plate attached to the inside of the door for the equipment area. You will need this number to properly register your spa and activate coverage. Write this information in the space provided below.

Spa Model: \_\_\_\_\_

Spa Serial Number: \_\_\_\_\_

Date Purchased: \_\_\_\_\_

Date Installed: \_\_\_\_\_

Dealer's Phone Number: \_\_\_\_\_

Dealer's Address: \_\_\_\_\_

It is important that you register your Cal Spas product as soon as possible. By taking just a few quick minutes to register, you can enjoy product alerts, more efficient support, and quicker service. Go to [www.calspas.com/warranty](http://www.calspas.com/warranty).

The logo for Cal Spas, featuring the brand name in a stylized, blue, cursive font with a registered trademark symbol.