

CalSpas®

OWNER'S MANUAL

Platinum &
Platinum Plus

2018

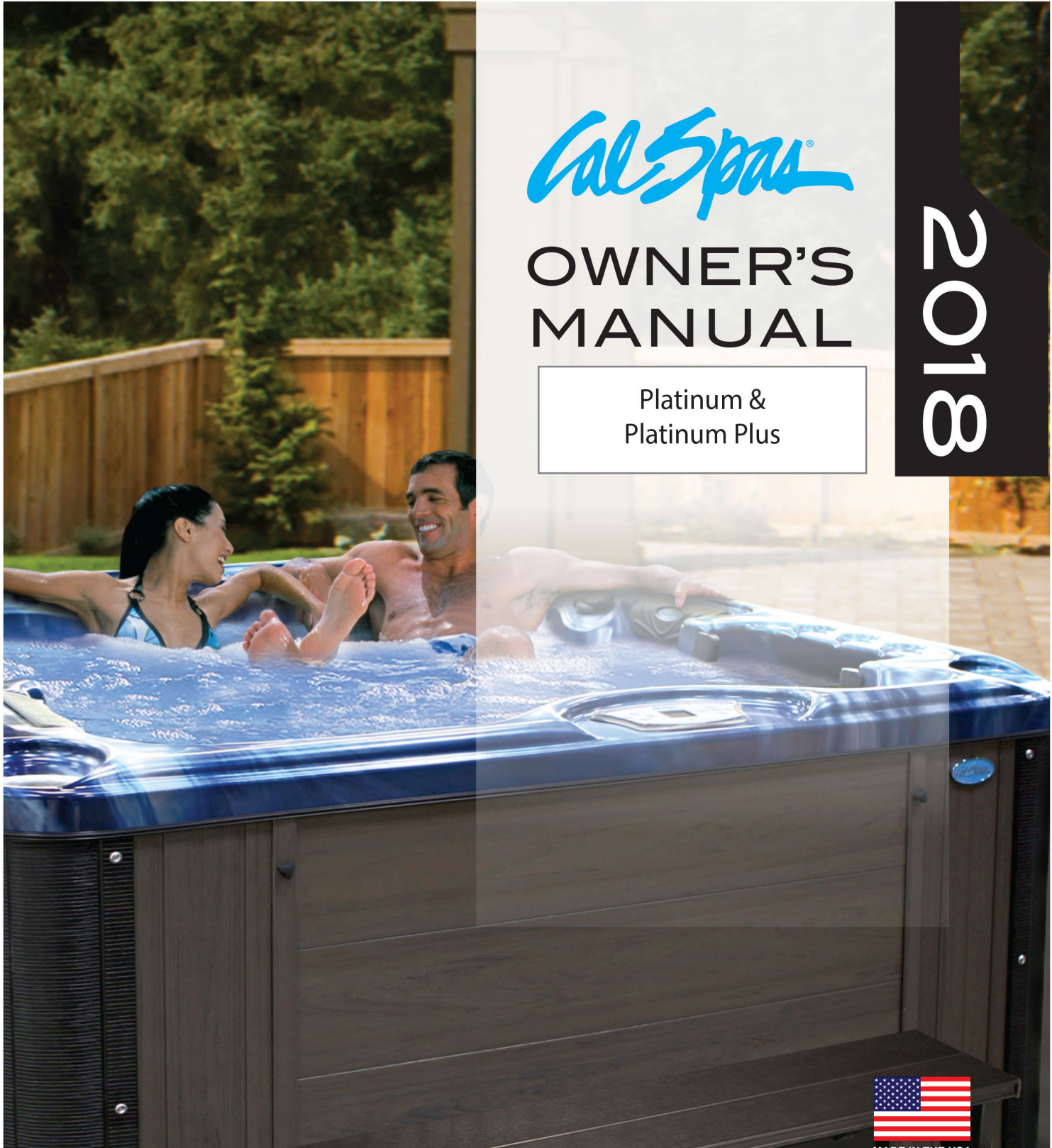

MADE IN THE USA

United States, Canada & Intl



2631-16-F

www.calspas.com

Table of Contents

Preparing for Your New Portable Spa

Pre-Delivery Checklist	3
Planning the Best Location	3
Preparing a Good Foundation	4
240 Volt Electrical Installation	4
GFCI Wiring Diagram for US & Canada	5
Wiring Diagram for Europe	6
Filling and Powering Up Your Portable Spa	7
Priming the Pump	9

Operating Your Spa

spaTouch-2 Icon Driven Control Panel	11
Changing Languages for the Display	11
Connecting to a Device or Network	22
Electrical Power Efficiency	23
Jets	23
LED Lighting	23
Diverter Knobs	24
Air Venturis	24
Waterfalls	24
ATS Plus Therapy System	25
Aquatic Air Therapy™ (AAT)	26

Water Clarity

The Key to Clear Water	27
Testing and Adjusting Spa Water	28
Sanitation	29
Bather Load	30
Filter Cleaning	30
Ozonator	30
Bromine Generator	31
Maintenance Schedule	33
Troubleshooting Water Clarity Problems	34

Cleaning and Maintenance

Removing and Reseating the Pillows	35
Jet Removal and Replacement	35
Spa Cover	35
Draining Your Portable Spa	36
Winterizing (Cold Climate Draining)	37
Cleaning and Replacing the Filter	37
Vacation Care	38
Cleaning Your Spa	38

Appendix

Replacement Parts	39
Basic Troubleshooting	49
“Thermal Creep”	51
Limited Warranty	52

Copyright 2018 LMS. All rights reserved. Duplication without written consent is strictly prohibited.

Cal Spas®, Adjustable Therapy System™, ATS™, Cal Premium™, Cal Select™, Cal Stone™, XL™ Heater, and Ultimate Fitness Spa Series™ are registered trademarks.

Due to continuous improvement programs, all models, operation, and/or specifications are subject to change without prior notice.

LTR20181010, Rev. D
5/16/18

CONTACT INFORMATION

For customer service, please contact your authorized dealer immediately. If you need additional information and/or assistance, contact:

LMS Customer Service Department
1462 East Ninth Street
Pomona, CA 91766.

Toll Free: 1-800-CAL-SPAS
Fax: 1-909-629-3890

Important Safety Instructions

READ AND FOLLOW ALL INSTRUCTIONS.

DANGER -- Risk of accidental drowning:

Do not allow children to be in or around a spa unless a responsible adult supervises them. Keep the spa cover on and locked when not in use. See instructions enclosed with your cover for locking procedures.

DANGER -- Risk of injury:

The suction fittings in this spa are sized to match the specific water flow created by the pump. Should the need arise to replace the suction fittings, or the pump, be sure the flow rates are compatible.

Never operate the spa if the suction fitting or filter baskets are broken or missing. Never replace a suction fitting with one that is rated less than the flow rate marked on the original suction fitting.

DANGER -- Risk of electric shock:

Install the spa at least 5 feet (1.5 meters) from all metal surfaces. As an alternative, a spa may be installed within 5 feet of metal surfaces if each metal surface is permanently bonded by a minimum #8 AWG solid copper conductor to the outside of the spa's control box.

Do not permit any external electrical appliances, such as lights, telephones, radios, televisions, and etc., within five feet (1.5 meters) of the spa. Never attempt to operate any electrical device from inside the spa.

Replace a damaged power cord immediately.

Do not bury the power cord.

Connect to a grounded, grounding-type receptacle only.

WARNING -- To reduce the risk of injury:

The spa water should never exceed 104°F (40°C). Water temperatures between 100°F (38°C) and 104°F (40°C) are considered safe for a healthy adult. Lower water temperatures are recommended for young children and when spa use exceeds 10 minutes.

High water temperatures have a high potential for causing fetal damage during pregnancy. Women who are pregnant, or who think they are pregnant, should always check with their physician prior to spa usage.

The use of alcohol, drugs or medication before or

during spa use may lead to unconsciousness, with the possibility of drowning.

Persons suffering from obesity, a medical history of heart disease, low or high blood pressure, circulatory system problems or diabetes should consult a physician before using the spa.

Persons using medications should consult a physician before using the spa since some medications may induce drowsiness while others may affect heart rate, blood pressure and circulation.

HYPERTHERMIA DANGER:

Prolonged exposure to hot air or water can induce hyperthermia. Hyperthermia occurs when the internal temperature of the body reaches a level 3°F to 6°F above the normal body temperature of 98.6°F (or 2°C to 4°C above 37°C). While hyperthermia has many health benefits, it is important not to allow your body's core temperature to rise above 103°F (39.5°C).

Symptoms of excessive hyperthermia include dizziness, lethargy, drowsiness and fainting. The effects of excessive hyperthermia may include:

- Failure to perceive heat
- Failure to recognize the need to exit spa or hot tub
- Unawareness of impending hazard
- Fetal damage in pregnant women
- Physical inability to exit the spa
- Unconsciousness

WARNING: The use of alcohol, drugs, or medication can greatly increase the risk of fatal hyperthermia.

WARNING: People with infectious diseases should not use a spa or hot tub.

WARNING: To avoid injury, exercise care when entering or exiting the spa or hot tub.

WARNING: Do not use drugs or alcohol before or during the use of a spa or hot tub to avoid unconsciousness and possible drowning.

WARNING: Do not use a spa or hot tub immediately following strenuous exercise.

WARNING: Prolonged immersion in a spa or hot tub may be injurious to your health.

CAUTION: Maintain water chemistry in accordance with manufacturer's instructions.

SAVE THESE INSTRUCTIONS.

Preparing for Your New Portable Spa

Pre-Delivery Checklist

Most cities and counties require permits for exterior construction and electrical circuits. In addition, some communities have codes requiring residential barriers such as fencing and/or self-closing gates on property to prevent unsupervised access to the property by children. Your dealer can provide information on which permits may be required and how to obtain them prior to the delivery of your spa.

Before Delivery	
	Plan your delivery route
	Choose a suitable location for the spa
	Lay a 5 - 8 cm concrete slab
	Install dedicated electrical supply
After Delivery	
	Place spa on slab
	Connect electrical components

Planning the Best Location

Safety First

Do not place your spa within 10 feet (3 m) of overhead power lines.

Consider How You Will Use Your Spa

How you intend to use your spa will help you determine where you should position it. For example, will you use your spa for recreational or therapeutic purposes? If your spa is mainly used for family recreation, be sure to leave plenty of room around it for activity. If you will use it for relaxation and therapy, you will probably want to create a specific mood around it.

Plan for Your Environment

If you live in a region where it snows in the winter or rains frequently, place the spa near a house entry. By doing this, you will have a place to change clothes and not be uncomfortable.

Consider Your Privacy

In a cold-weather climate, bare trees won't provide much privacy. Think of your spa's surroundings during all seasons to determine your best privacy options. Consider the view of your neighbors as well when you plan the location of your spa.

Provide a View with Your Spa

Think about the direction you will be facing when sitting in your spa. Do you have a special landscaped area in your yard that you find enjoyable? Perhaps there is an area that catches a soothing breeze during the day or a lovely sunset in the evening.

Keep Your Spa Clean

In planning your spa's location, consider a location where the path to and from the house can be kept clean and free of debris.

Prevent dirt and contaminants from being tracked into your spa by placing a foot mat at the spa's entrance where the bathers can clean their feet before entering your spa.

Allow for Service Access

Make sure the spa is positioned so that access to the equipment compartment and all side panels will not be blocked.

Many people choose to install a decorative structure around their spa. If you are installing your spa with any type of structure on the outside, such as a gazebo, remember to allow access for service. It is always best to design special installations so that the spa can still be moved, or lifted off the ground.

Preparing a Good Foundation

Your spa needs a solid and level foundation. The area that it sits on must be able to support the weight of the spa, with water and the occupants who use it. If the foundation is inadequate, it may shift or settle after the spa is in place, causing stress that could DAMAGE YOUR SPA SHELL AND FINISH.

Damage caused by inadequate or improper foundation support is not covered by the warranty. It is the responsibility of the spa owner to provide a proper foundation for the spa.

Place the spa on an elevated 3 to 4" / 30 cm concrete slab. Pavers, gravel, brick, sand, timbers or dirt foundations are **not** adequate to support the spa.

We strongly recommend that a qualified, licensed contractor prepare the foundation for your spa.

If you are installing the spa indoors, pay close attention to the flooring beneath it. Choose flooring that will not be damaged or stained.

If you are installing your spa on an elevated wood deck or other structure, it is highly recommended that you consult a structural engineer or contractor to ensure the structure will support the weight of

150 pounds per square foot (732 kg / m²).

To properly identify the weight of your new spa when full, remember water weighs 8.33 lbs. per gallon, or 1 kg per liter. For example, an average 8' spa holds approximately 500 gallons, or 1892 liters, of water. Using this formula, you will find that the weight of the water alone is 4,165 lbs, or 1892 kg. Combined with the dry weight of the spa you will note that this spa will weigh approximately 5,000 lbs, or 2267 kg, when full of water.



240 Volt Electrical Installation

All 240V spas must be permanently connected (hard wired) to the power supply.

Use one 50 amp GFCI with four #6 AWG copper wires. See the wiring diagram on page 5.

These instructions describe the only acceptable electrical wiring procedure. Spas wired in any other way will void your warranty and may result in serious injury.

When installed in the United States, the electrical wiring of this spa must meet the requirements of NEC 70 and any applicable local, state, and federal codes.

The electrical circuit must be installed by an electrical contractor and approved by a local building or electrical inspector.

Failure to comply with state and local codes

may result in fire or personal injury and will be the sole responsibility of the spa owner.

The power supplied to the spa must be on a dedicated GFCI protected circuit as required by NEC 70 with no other appliances or lights sharing the power.

Use copper wire with THHN insulation. Do not use aluminum wire.

Use the table below and on the next page to determine your GFCI and wiring requirements.

Wires that run over 100 feet must increase wire gauge to the next lower number. For example: A normal 50 amp GFCI with four #6 AWG copper wires that run over 100 feet would require you to go to four #4 AWG copper wires.

GFCI Wiring Diagram for US & Canada

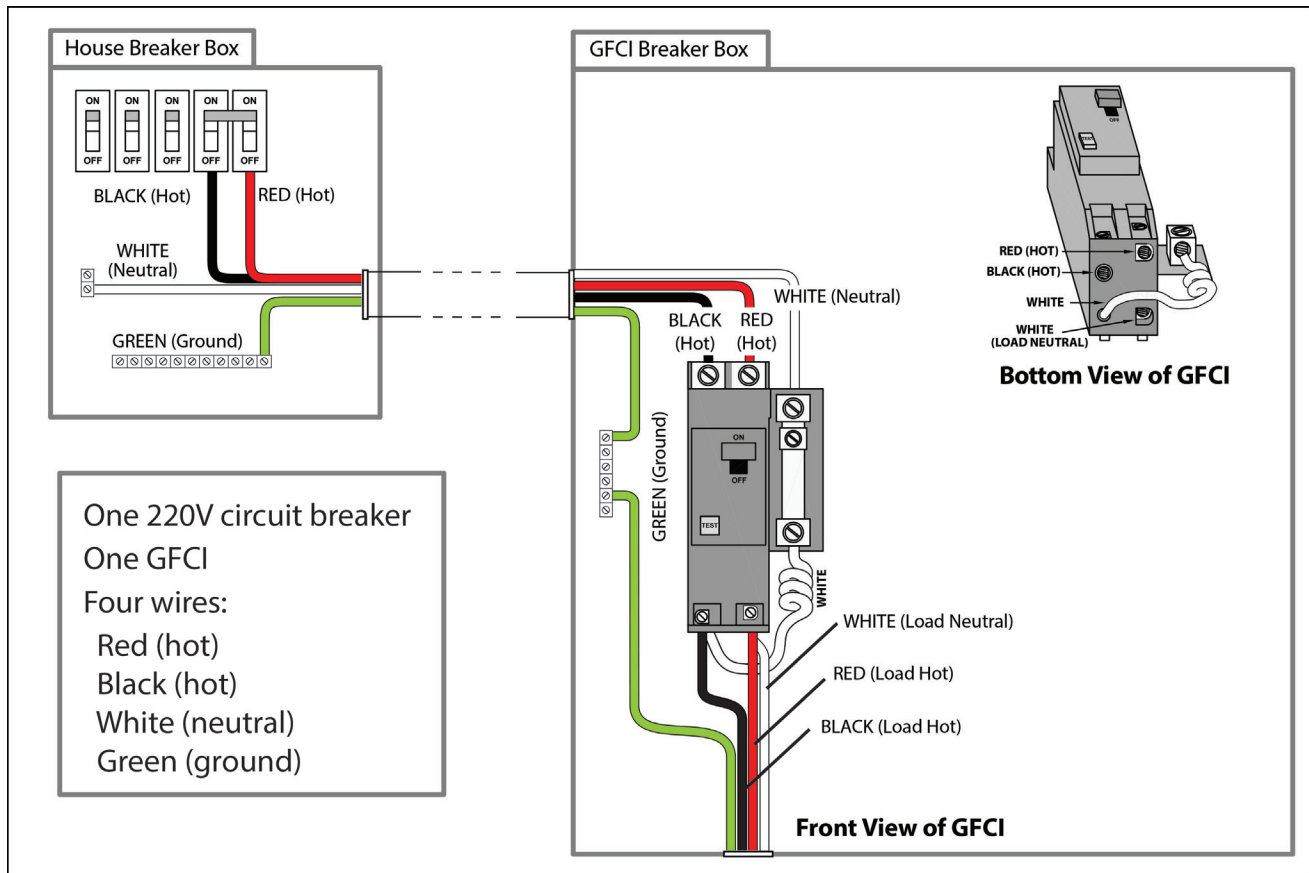

See the Cal Spas Pre-Delivery Guide for more information on spa placement for service access and electrical service.

www.calspas.com/manuals

Testing the GFCI Breaker

Test the GFCI breaker prior to first use and periodically when the spa is powered. To test the GFCI breaker follow these instructions (spa should be operating):

1. Press the TEST button on the GFCI. The GFCI will trip and the spa will shut off.
2. Reset the GFCI breaker by switching the breaker to the full OFF position, wait a moment, then turn the breaker back on. The spa should have power again.

Wiring Diagram for Europe

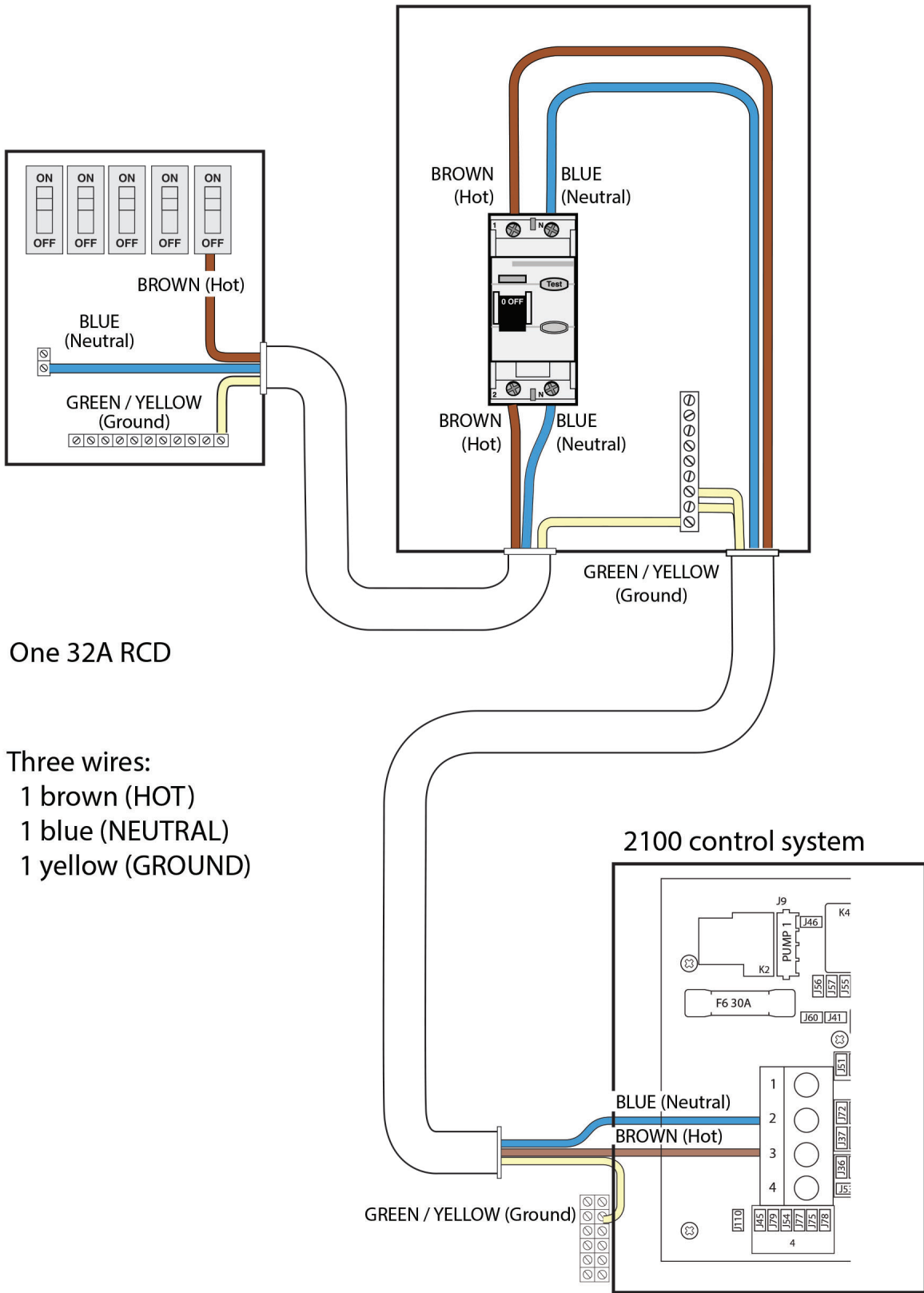

One 32A RCD

Three wires:

- 1 brown (HOT)
- 1 blue (NEUTRAL)
- 1 yellow (GROUND)

Filling and Powering Up Your Portable Spa

This applies to all spa owners **EXCEPT** those with the Cal Clarity II bromine generator. See instructions on page 31 for bromine generator operating instructions and spa filling procedures.

1. Inspect the spa equipment.

Inspect all plumbing connections in the equipment area of your spa.

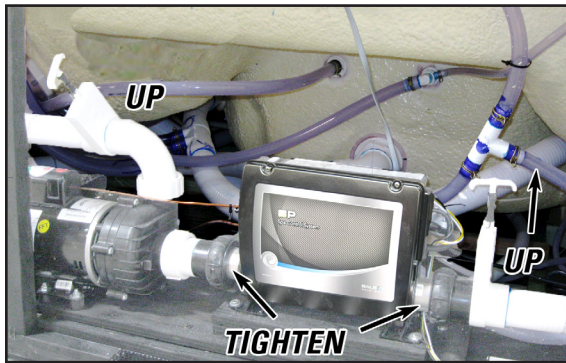

- Make sure unions in the equipment pack are tight. (Be careful not to over-tighten the plumbing fittings.)
- If your spa has gate valves, make sure they are all in the UP or OPEN position.
- Make sure the drain valve is closed and capped. (See page 36 for a description of drain valves.)

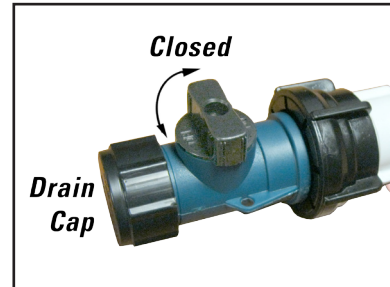

- ⚠ Never run the spa with the gate valves closed or without water circulating for long periods of time.

2. Remove the cartridge from filter canister.



Unscrew the cartridge and remove it.

- ⚠ After you remove the filter, remove the plastic wrapper and soak it in water for 30 minutes before you replace it. A dry filter can allow air into the filtration system which can cause the pump to fail to prime. Never try to pull the filter cartridge while the spa is running in low or high speed (i.e., any speed).

3. Fill the spa.



Place a garden hose in the filter canister and fill your spa with **regular tap water** about six inches from the top.

If the water level is too low or too high, your spa will not operate properly.

- ⚠ Always fill the spa through the filter canister! Failure to do so may cause air to be trapped in the filtration system and prevent the pumps from operating properly.

⚠ Never fill your spa with soft water.

Soft water makes it impossible to maintain the proper water chemistry and may cause the water to foam, which will ultimately harm the finish of the spa and void your warranty.

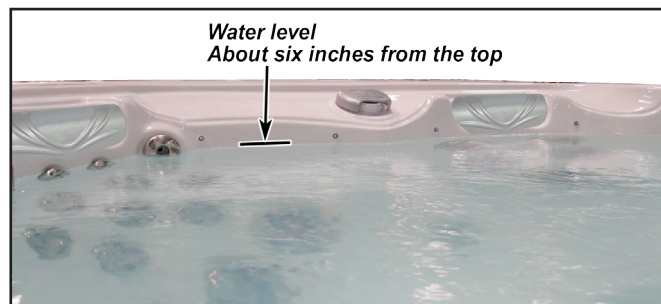

4. Turn on power to the spa.



When the spa is filled to the correct level, turn on the power at the GFCI breaker. (Ensure that the 120V spas are connected to the proper electrical outlet.)

5. Prime the pump.

After the initial start-up sequence, the control will enter Priming Mode and display a Priming Mode screen. Only pump icons appear on the priming mode screen. During the priming mode, the heater is disabled to allow the priming process to be completed without the possibility of energizing the heater under low-flow or no-flow conditions. Nothing comes on automatically, but the pump(s) can be energized by selecting the “Jet” buttons. If the spa has a Circ Pump, it can be turned on and off by pressing the “Circ” button during Priming Mode.

6. Install the filter into the filter canister.



Make sure the filter has soaked at least 30 minutes before you install it. Insert the filter all the way and screw it in. Do not over-torque the cartridge during installation, just hand tighten gently.

7. Adjust water chemistry.

Test and adjust the water chemistry. See the section on page 27 for instructions on water clarity.

8. Let the spa heat up.

When the spa has finished priming, the heater will activate. Put the cover on and let the spa heat to the set temperature.

Priming the Pump

New spa owners often have difficulty the first time they start their spa and the pump fails to prime. This can be frustrating, but these simple instructions can help you.



The pump will not work properly while air is trapped in it. Continuing to operate the pump in this way will cause damage.

Sometimes air can become trapped in the pump while filling the spa. You will know this has happened when after you have filled and started the spa, the pump does not seem to function. You will hear the pump operating, but no water will be moving.

Starting Up: Priming Mode

Priming Mode – M019

After the initial start-up sequence, the control will enter Priming Mode and display a Priming Mode screen. Only pump icons appear on the priming mode screen. During the priming mode, the heater is disabled to allow the priming process to be completed without the possibility of energizing the heater under low-flow or no-flow conditions. Nothing comes on automatically, but the pump(s) can be energized by selecting the “Jet” buttons. If the spa has a Circ Pump, it can be turned on and off by pressing the “Circ” button during Priming Mode.

Automatic Exiting of Priming Mode

The system will automatically enter the normal heating and filtering at the end of the priming mode, which lasts 4-5 minutes.

— — — — °F — — — — °C

Bleeding Air from the Pump

If you have tried priming the pump several times unsuccessfully using the control panel, you can bleed the air from the pump manually.

1. Shut off the power to the spa.
2. Using a Phillips screwdriver, remove the front panel from the spa and locate the pump.
3. Close the gate valve on the discharge side of the pump (if your spa is installed with one.)
4. Turn the bleeder valve counter clockwise with a small pair of pliers until the air has been released from the pump.
5. If this is unsuccessful, loosen the union nut on side of the pump with channel locks. When air is bled out, tighten the nut.
6. Turn on power to the spa and press the JETS button. If there is still air trapped in the pump, repeat steps 2 through 5 until the pump primes.

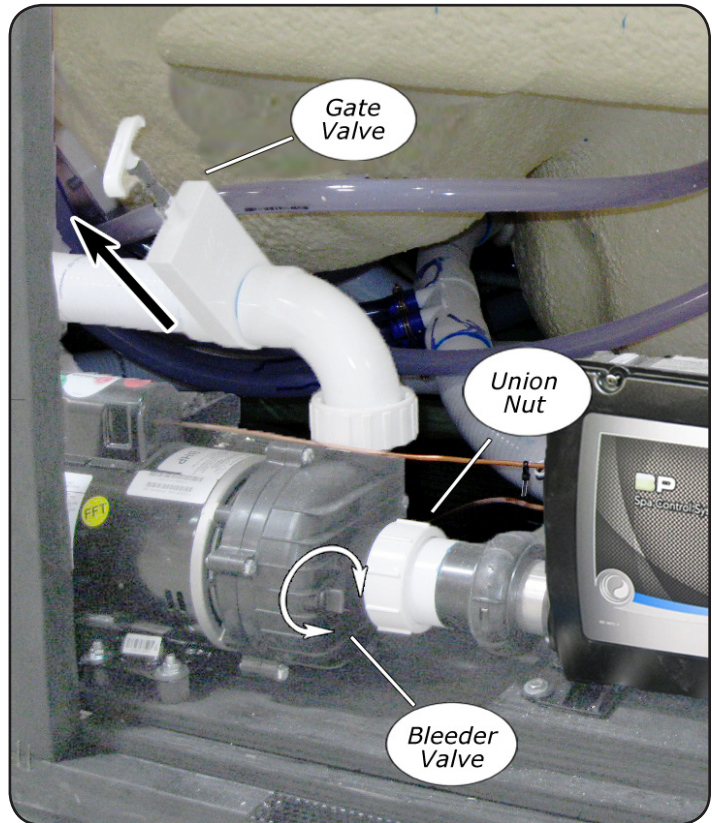

Operating Your Spa

spaTouch-2 Icon Driven Control Panel



Changing Languages for the Display

1. Touch the **Settings** Icon at the lower right portion of the screen.

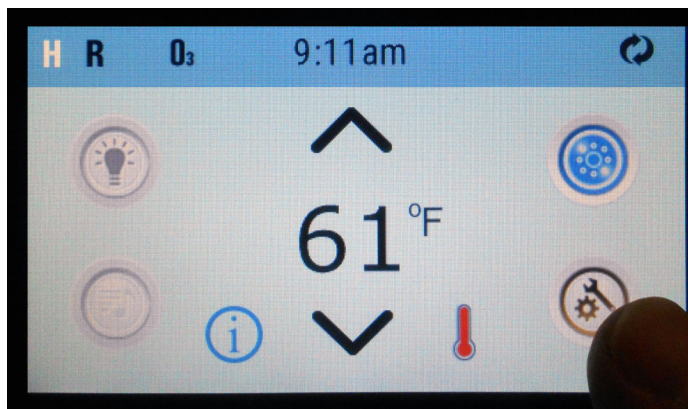

2. Touch the **Right Arrow** Icon at the lower right portion of the screen. It takes you to the next page.

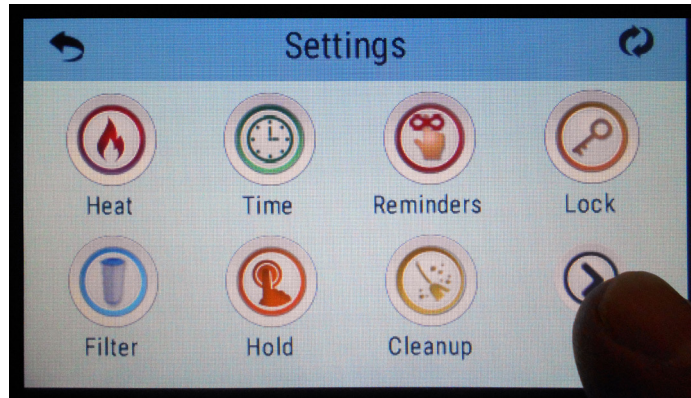

3. Touch the **Language** Icon.

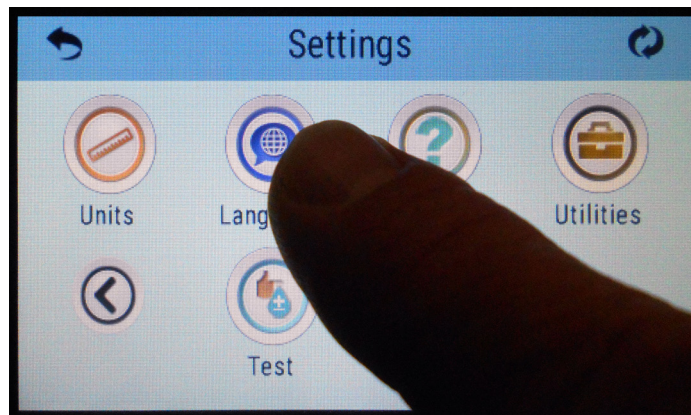

Language

The Language Icon  on the Settings Screen takes you to the Language screen. Change the language displayed on the panel.



4. As an example, touch the **Spanish** option as shown below.

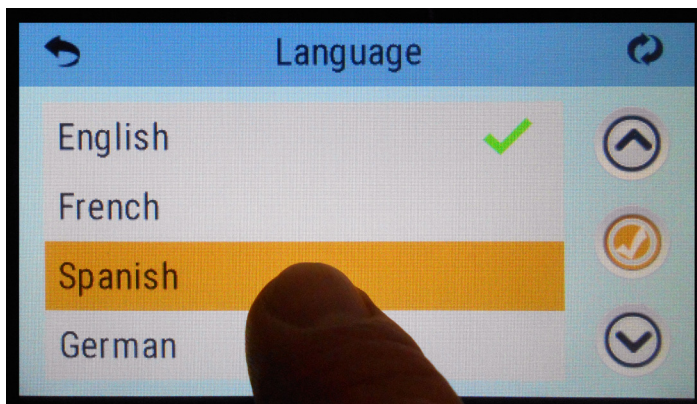

5. Next, touch the **Save** Icon to confirm this selection.

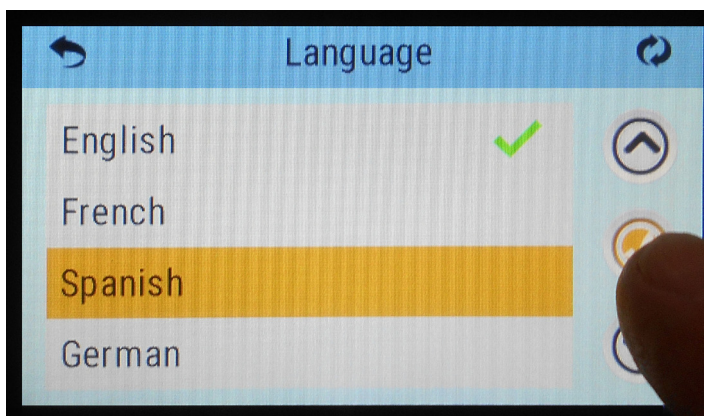

6. ...and now (for example), the spaTouch screen will be reset to **Spanish**.

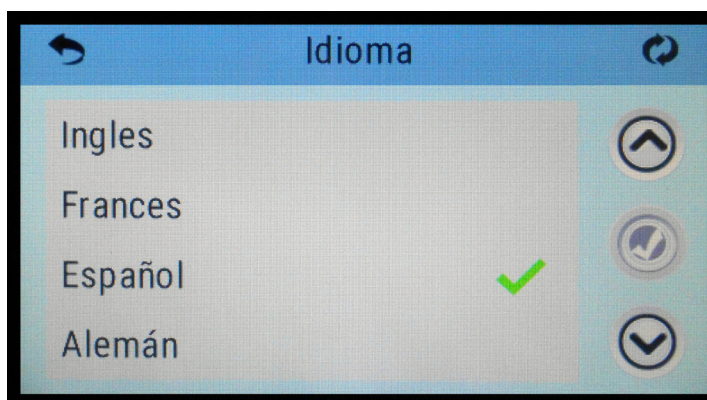

The Main Screen (Home)

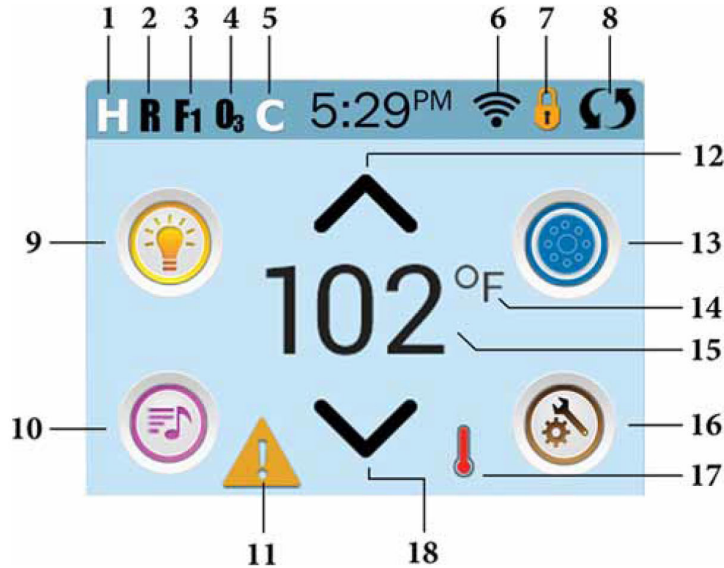

Note: After 30 minutes* the display will automatically go into sleep mode, which turns the display off. This is normal operation. Touch anywhere on the screen to wake the panel up.

ICON Specifications

1. H = High Temperature Range
2. R = Ready Mode
3. F1 = Filter Cycle 1 Running
4. O₃ = Ozone Running
5. C = Cleanup Cycle
6. Wi-Fi Signal Indicator
7. Lock Indicator Icon
8. Invert Screen
9. Light Icon = Turns On/Off
10. Music Icon = Press To Enter Music Screen
11. Message Waiting Indicator
12. Set Temperature Up
13. Spa Equipment Control Icon
14. Temperature Scale (F/C)
15. Current Water Temperature
16. Settings Icon
17. Heat Indicator
18. Set Temperature Down

Navigation

Navigating the entire menu structure is done by touching the screen.

The three screen selections indicated below can be selected. Touch one of these to enter a different screen with additional controls.

Most menu screens time out and revert to the main screen after 30 seconds of no activity.

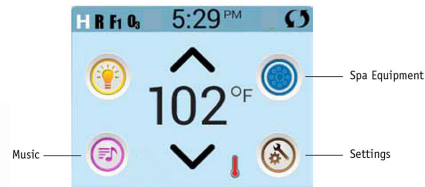

Messages

At the bottom of the screen, at certain times an indicator may appear showing that a message is waiting. Touch this indicator to go to the Message Display Screen. On that Screen some of the messages can be dismissed.



Set Temperature

Press Up or Down once to display the Set Temperature (indicated by a flashing °F or °C, plus a change in color of the temperature). Press Up or Down again to modify the Set Temperature. The Set Temperature changes immediately.

If you need to switch between High Temperature Range and Low Temperature Range you need to go to the Settings Screen.

Press-and-Hold

If Up or Down is pressed and held, the temperature will continue to change until you stop pressing, or until the Temperature Range limits are reached.

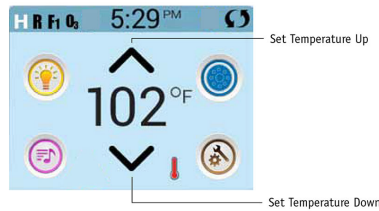

All Equipment Access

The Spa Screen shows all available equipment* to control. The display shows icons that are related to the equipment installed on a particular spa model, so this screen may change depending on the installation.

The icon buttons are used to select and control individual devices.

Some devices, like pumps, may have more than one ON state, so the icon will change to reflect the state of the equipment. Below are some examples of 2-speed Pump indicators.

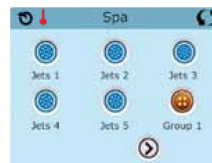

If the Spa has a Circ Pump, a Circ Pump Icon will appear to indicate its activity, but outside of Priming Mode, the Circ Pump cannot be controlled directly.

Values Increment/Decrement

If an Up or Down button is shown and pressed when on an editing page, and a value has been selected (highlighted), the value can be incremented by pressing the up arrow or decremented by pressing the down arrow.

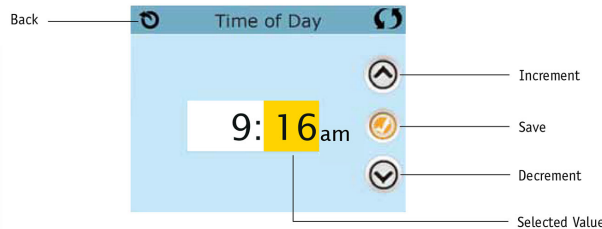

Invert

Will appear on upper right on all screens.



Exiting Screens

The Back button is on every screen except the Main Screen, the Priming Mode Screen are a Message Display Screen.

When you see only this button, or this button plus an Inactive Save Button, it means Back or Exit. It appears on editing screens before you have changed any value, as well as on all other screens.

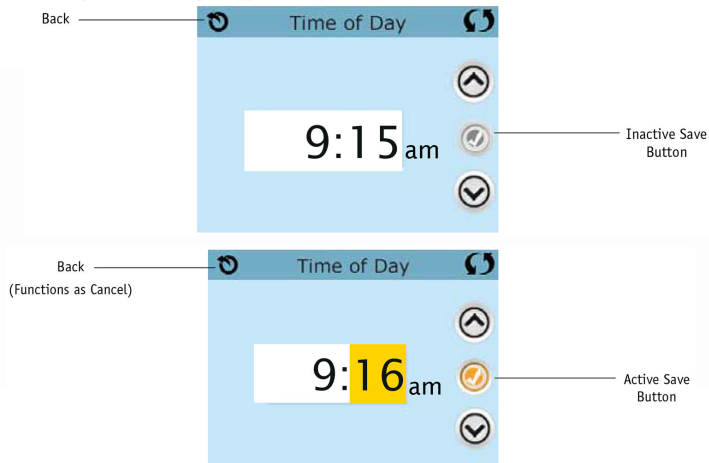

When you see both the Back button and an Active Save button, the Save button will Save, while the Back button will Cancel. If the screen times out due to no activity it will act like Cancel.

Page Right/Left

If there is a right arrow at the bottom of the screen, it takes you to the next page.

If there is a left arrow at the bottom of the screen, it takes you to the previous page.



Page Up/Down

If an Up or Down button is shown and pressed when on a page with a text list, the list can be scrolled a page at a time.

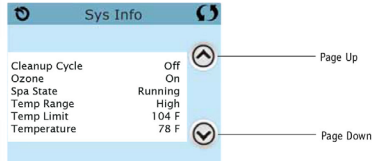

Programming, Etc.

The Settings Screen is where all programming and other spa behaviors are controlled.

Each icon on the Settings screen takes you to a different screen, where one or more setting may be viewed and/or edited.



The Heat Icon  takes you to a screen where you control the Heat Mode and the Temperature Range.

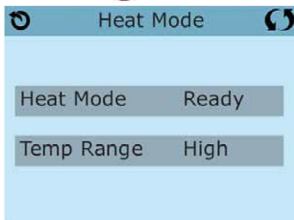

Dual Temperature Ranges (High vs. Low)

This system incorporates two temperature range settings with independent set temperatures. The specific range can be selected on the Settings screen and is visible on the Main Screen in the upper left corner of the display.

These ranges can be used for various reasons, with a common use being a "ready to use" setting vs. a "vacation" setting. Each range maintains its own set temperature as programmed by the user. This way, when a range is chosen, the spa will heat to the set temperature associated with that range.

High Range can be set between 80°F and 104°F.

More specific Temp Ranges may be determined by the Manufacturer.

Low Range can be set between 50°F and 99°F.

Freeze Protection is active in either range.

Heat Mode – Ready vs. Rest

In order for the spa to heat, a pump needs to circulate water through the heater. The pump that performs this function is known as the "heater pump."

The heater pump can be either a 2-speed pump (Pump 1) or a circulation pump.

If the heater pump is a 2-Speed Pump 1, Ready Mode will circulate water every 1/2 hour, using Pump 1 Low, in order to maintain a constant water temperature, heat as needed, and refresh the temperature display. This is known as "polling."

Rest Mode will only allow heating during programmed filter cycles. Since polling does not occur, the temperature display may not show a current temperature until the heater pump has been running for a minute or two.

When the heater pump has come on automatically (for example for heating) you can switch between low speed and high speed but you cannot turn the heater pump off.

Circulation Mode (See Page 13, under Pumps, for other circulation modes)

If the spa is configured for 24HR circulation, the heater pump generally runs continuously. Since the heater pump is always running, the spa will maintain set temperature and heat as needed in Ready Mode, without polling.

In Rest Mode, the spa will only heat to set temperature during programmed filter times, even though the water is being filtered constantly when in 24HR circulation mode.

Ready-in-Rest Mode

Ready in Rest Mode appears in the display if the spa is in Rest Mode and the Jets 1 Button is pressed. When the heater pump has come on automatically (for example for heating) you can switch between low speed and high speed but you cannot turn the heater pump off. After 1 hour, the System will revert to Rest Mode. This mode can also be reset by selecting the Heat Mode line on the Screen shown here.

Priming Mode – M019

After the initial start-up sequence, the control will enter Priming Mode and display a Priming Mode screen. Only pump icons appear on the priming mode screen. During the priming mode, the heater is disabled to allow the priming process to be completed without the possibility of energizing the heater under low-flow or no-flow conditions. Nothing comes on automatically, but the pump(s) can be energized by selecting the “Jet” buttons. If the spa has a Circ Pump, it can be turned on and off by pressing the “Circ” button during Priming Mode.

Exiting Priming Mode

The system will automatically enter the normal heating and filtering at the end of the priming mode, which lasts 4-5 minutes.

— — — °F — — — °C

Filtration and Ozone

On non-circ systems, Pump 1 low and the ozone generator will run during filtration. On circ systems, the ozone will generally run with the circ pump, but can be limited to filtration cycles. (On some circs systems, Pump 1 low will run along with the circ Pump during filtration.)

The system is factory-programmed with one filter cycle that will run in the evening (assuming the time-of-day is properly set) when energy rates are often lower. The filter time and duration are programmable.

A second filter cycle can be enabled as needed.

At the start of each filter cycle, the water devices like blower, mister device (if these exist) and other pumps will run briefly to purge the plumbing to maintain good water quality.

Freeze Protection

If the temperature sensors within the heater detect a low enough temperature, then the water devices automatically activate to provide freeze protection. The water devices will run either continuously or periodically depending on conditions.

In colder climates, an optional freeze sensor may be added to protect against freeze conditions that may not be sensed by the standard sensors. Auxiliary freeze sensor protection acts similarly except with the temperature thresholds determined by the switch. See your dealer for details.

Clean-up Cycle (optional)

When a pump or blower is turned on by a button press, a clean-up cycle begins 30 minutes after the pump or blower is turned off or times out. The pump and the ozone generator will run for 30 minutes or more, depending on the system. On some systems, you can change this setting.

Be sure to set the Time-of-Day

Setting the time-of-day is important for determining filtration times and other background features.

The Heat Icon  on the Settings Screen takes you to a screen where you control the Time-of-Day.

On the Time-of-Day screen, simply select the Hours and Minutes. Use the Up and Down Buttons to make changes, then Save.

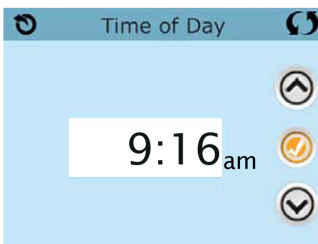

If no time-of-day is set in the memory an Information Screen will appear. If you exit it and Information Icon will appear at the bottom of the Main Screen, until the time-of-day has been set.

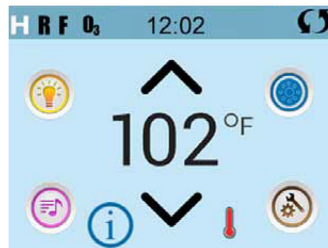

Note:

This only applies to some systems: If power is interrupted to the system, Time-of-Day will be maintained for several days.

Main Filtration

Using the same adjustment as Setting the Time, Filter Cycles are set using a start time and a duration. Each setting can be adjusted in 15-minute increments. The panel calculates the end time and displays it automatically.

The Filter Icon  on the Settings Screen takes you to a screen where you control the Filter Cycles.

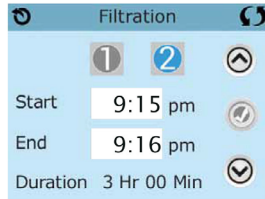

Filter Cycle 2 - Optional Filtration

Filter Cycle 2 is OFF by default.

Viewing Filter 1 while Filter 2 is OFF:

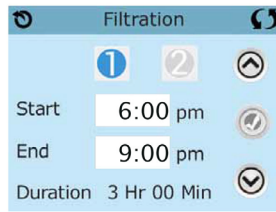

Viewing Filter 1 while Filter 2 is ON:

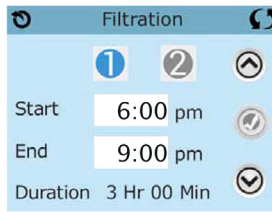

Press "1" to view Filter 1. Press "2" once to view Filter 2. Press "2" again to turn Filter 2 ON or OFF.

When Filter Cycle 2 is ON, it can be adjusted in the same manner as Filter Cycle 1.

It is possible to overlap Filter Cycle 1 and Filter Cycle 2, which will shorten overall filtration by the overlap amount.

Light Cycle Option

If Light Cycle does not appear on the Settings Screen, the Light Timer feature is not enabled by the manufacturer.

The Light Cycle Icon  on the Settings Screen takes you to a screen where you control the Light Cycle.

When available, the Light Timer is ("Disabled") by default. Press "Disabled" to change it to "Enabled" (ON).

The settings can be edited the same way that Filter Cycles are edited.



Restricting Operation

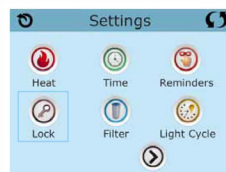

Panel Locked and Settings Unlocked



The control can be restricted to prevent unwanted use or temperature adjustments.

Locking the Panel prevents the controller from being used, but all automatic functions are still active.

Locking the Settings allows Jets and other features to be used, but the Set Temperature and other programmed settings cannot be adjusted.

Settings Lock allows access to a reduced selection of menu items. These include Filter Cycles, Invert, Information and Fault Log. They can be seen, but not changed or edited.

Locking and Unlocking

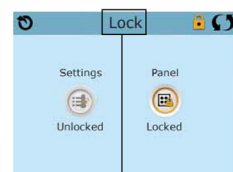

Press here for 5 seconds
to lock or unlock.

The same steps are used to Lock and Unlock.

To lock either Settings or Panel first select Settings (if it says "Unlocked") or Panel (if it says "Unlocked"), then press the word "Lock" for at least 5 seconds.

To unlock either Settings or Panel first select Settings (if it says "Locked") or Panel (if it says "Locked"), then press the word "Lock" for at least 5 seconds.

Hold - M037

Hold Mode is used to disable the pumps during service functions like cleaning or replacing the filter. Hold Mode will last for 1 hour unless the mode is exited manually. If spa service will require more than an hour, it may be best to simply shut down power to the spa.

The Hold Icon  on the Settings Screen places the spa in Hold Mode and displays the System Hold screen. Touch Back to exit Hold Mode.

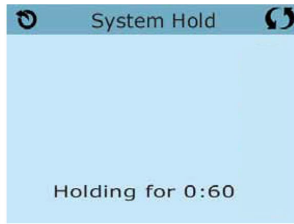

Drain Mode

Some spas have a special feature that allows Pump 1 to be employed when draining the water. When available, this feature is a component of Hold Mode.

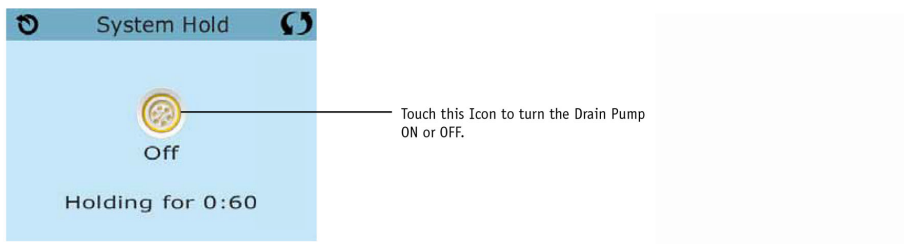

Utilities

The Utilities Icon  on the Settings Screen takes you to the Utilities Screen.

The Utilities Screen contains the following:

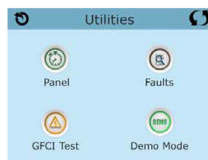

Panel

Touching the Panel Icon  on the Utilities Screen takes you to the Panel Screen, where you can set how long it takes the panel to go to sleep after the last activity. The Sleep Timer can be set from 1 minute to 60 minutes. The default is 30 minutes.

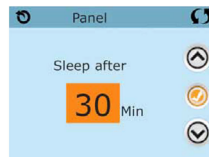

Demo Mode

Demo Mode is not always enabled, so it may not appear. This is designed to operate several devices in a sequence in order to demonstrate the various features of a particular hot tub.

Fault Log

The Fault Log is a record of the last 24 faults that can be reviewed by a service tech.

Use the Up and Down buttons to view each of the Faults.

When Priming Mode shows in the Fault Log, it is not a fault. Rather, it is used to keep track of spa restarts.

Units Screen

The Units Icon  on the Settings Screen takes you to the Units Screen.

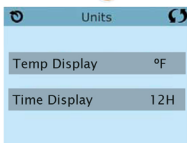

Press "Temp Display" to change the temperature between Fahrenheit and Celsius.
Press "Time Display" to change the clock between 12 hr and 24 hr display.

Reminders

The Reminder Icon  on the Settings Screen takes you to the Reminders screen.

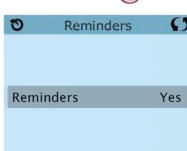

Press "Reminders" to turn the reminder messages (like "Clean Filter") ON (Yes) or OFF (No).

Cleanup Cycle

Cleanup Cycle Duration is not always enabled, so it may not appear. When it is available, set the length of time Pump 1 will run after each use. 0-4 hours are available. Settings it to 0.0 Hr keeps the Cleanup Cycles from running.

The Cleanup Icon  on the Settings Screen takes you to the Cleanup Cycle screen.

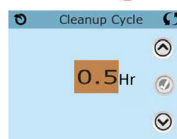

Language

The Language Icon  on the Settings Screen takes you to the Language screen.

Change the language displayed on the panel.



Most messages and alerts will appear at the bottom of the normally used screens. Several alerts and messages may be displayed in a sequence.

-----°F -----°C

Water Temperature is Unknown

After the pump has been running for 1 minute, the temperature will be displayed.



Possible freezing condition

A potential freeze condition has been detected, or the Aux Freeze Switch has closed. All water devices are activated.

In some cases, pumps may turn on and off and the heater may operate during Freeze Protection.

This is an operational message, not an error indication.

The water is too hot – M029

The system has detected a spa water temp of 110°F (43.3°C) or more, and spa functions are disabled. System will auto reset when the spa water temp is below 108°F (42.2°C). Check for extended pump operation or high ambient temp.

Heater-Related Messages

The water flow is low – M016

There may not be enough water flow through the heater to carry the heat away from the heating element. Heater start up will begin again after about 1 min. See “Flow Related Checks” below.

The water flow has failed* – M017

There is not enough water flow through the heater to carry the heat away from the heating element and the heater has been disabled. See “Flow Related Checks” below. After the problem has been resolved, reset the message*.

The heater may be dry* – M028

Possible dry heater, or not enough water in the heater to start it. The spa is shut down for 15 min. Reset this message* to reset the heater start-up. See “Flow Related Checks” below.

The heater is dry* – M027

There is not enough water in the heater to start it. The spa is shut down. After the problem has been resolved, you must reset the message* to restart heater start up. See “Flow Related Checks” below.

The heater is too hot* – M030

One of the water temp sensors has detected 118°F (47.8°C) in the heater and the spa is shut down. You must reset the message* when water is below 108°F (42.2°C). See “Flow Related Checks” below.

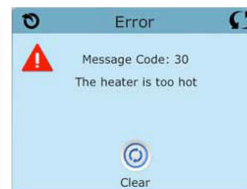

Flow-Related Checks

Check for low water level, suction flow restrictions, closed valves, trapped air, too many closed jets and pump prime.

On some systems, even when spa is shut down by an error condition, some equipment may occasionally turn on to continue monitoring temperature or if freeze protection is needed.

* **Some messages can be reset from the panel.** Messages that can be reset will appear with a Clear Icon at the bottom of the Message Screen. Press the Clear Icon text to reset the message.

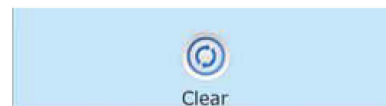

Sensor-Related Messages

Sensors are out of sync – M015**

The temperature sensors MAY be out of sync by 3°F. Call for Service if this message does not disappear within a few minutes.

Sensors are out of sync -- Call for service* – M026**

The temperature sensors ARE out of sync. The fault above has been established for at least 1 hour. Call for Service.

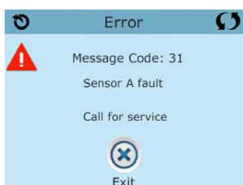

Sensor A Fault, Sensor B Fault – Sensor A: M031**, Sensor B: M032**

A temperature sensor or sensor circuit has failed. Call for Service.

Miscellaneous Messages

Communications error

The control panel is not receiving communication from the System. Call for Service.

Test software installed

The Control System is operating with test software. Call for Service.

* *Some messages can be reset from the panel.* Messages that can be reset will appear with a Clear Icon at the bottom of the Message Screen. Press the Clear Icon text to reset the message.

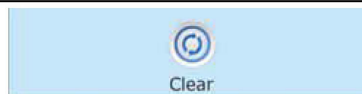

**MOXX is a Message Code. Codes like this will be seen in the Fault Log

System-Related Messages

Program memory failure* – M022**

At Power-Up, the system has failed the Program Checksum Test. This indicates a problem with the firmware (operation program) and requires a service call.

The settings have been reset (Persistent Memory Error)* – M021**

Contact your dealer or service organization if this message appears on more than one power-up.

The clock has failed* – M020**

Contact your dealer or service organization.

Configuration error (Spa will not Start Up)

Contact your dealer or service organization.

The GFCI test failed (System Could Not Test the GFCI) – M036**

(North America Only) May indicate an unsafe installation. Contact your dealer or service organization.

A pump may be stuck on – M034**

Water may be overheated. POWER DOWN THE SPA. DO NOT ENTER THE WATER. Contact your dealer or service organization.

Hot fault – M035**

A Pump Appears to have been Stuck ON when spa was last powered. POWER DOWN THE SPA. DO NOT ENTER THE WATER. Contact your dealer or service organization.

* *Some messages can be reset from the panel.* Messages that can be reset will appear with a Clear Icon at the bottom of the Message Screen. Press the Clear Icon text to reset the message.

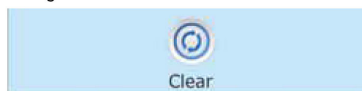

**MOXX is a Message Code. Codes like this will be seen in the Fault Log

Connecting to a Device or Network

1 Direct connection

Range: About 20 feet
Range limit: Limited to the range of the wi-fi module



HOW TO CONNECT TO IT:

Install the app on your phone or device -- see the following section "Installing the app".

2 Through home network with no internet access

Allows one local connection at a time

Range: About 50 feet
Range limit: Limited to the range of your home router's signal



HOW TO CONNECT TO IT:

1. Install the app on your phone or device.
2. Exit the app and go to wi-fi settings on your phone or device.
3. Select and enable your local router.
4. Start the app. After you connect, select Settings on the home screen.
5. On the Settings screen, select Advanced, then on the Advanced screen, select Wi-fi Settings.
6. On the Wi-fi screen, select WPA. Then select the name of your home router from the drop-down menu.
7. Enter the SSID and Key for your router, the tap Save and select OK twice.
8. Close the app and re-start it to connect to your home network.

3 Through a network with internet access, using Cloud connection or other hotspot connection

Allows unlimited simultaneous connections

Range: Worldwide
Range limit: Limited to 3G / 4G / hotspot availability

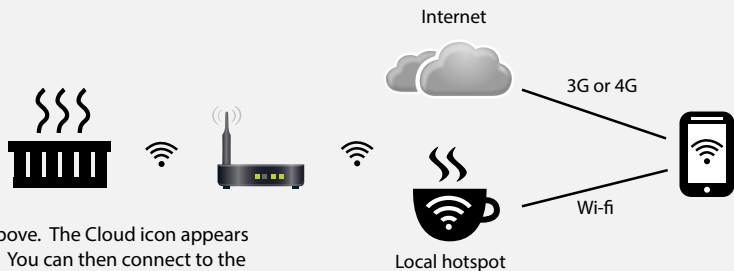

HOW TO CONNECT TO IT:

Follow connection instructions from section (2) above. The Cloud icon appears automatically when network connection is made. You can then connect to the spa's wi-fi module.

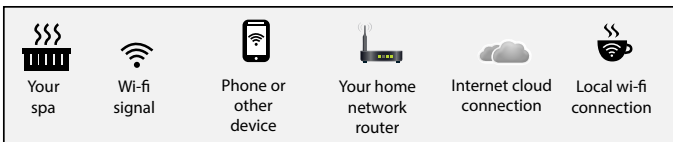

Electrical Power Efficiency

Your new spa comes equipped with an electric heater. Following the directions listed below will ensure the most efficient operation:

NOTE: This method is only for spa usage under two hours a week.

- Keep the spa's operating temperature 5°F below the desired usage temperature when not in use. One or two hours before use, set the temperature to the desired temperature.
- If the spa usage exceeds two hours a week, the set temperature should remain at the desired usage temperature.
- The air venturis should be used sparingly. When open, water temperature drops quite rapidly and can also dissipate chemicals.

Allowing the water temperature to lower more than 10°F below the desired usage temperature and reheating it prior to usage will cause the heater to operate longer than it normally would maintaining the desired temperature. Doing this will increase your operating cost and makes your heater work more than necessary.

Jets

Almost all of the jets in your spa are adjustable. Rotating the face of an adjustable jet to the left (counter-clockwise) will decrease the amount of water flow through the jet. Rotating the face of an adjustable jet to the right (clockwise) will increase the amount of water flow through the jet. (See example shown below.)

Neck jets adjust in the opposite directions (counter-clockwise to increase, clockwise to decrease).



LED Lighting

Press the LIGHT button on the topside control panel to turn the spa light on. If your spa has perimeter LED lights, they will also light up at the same time as the spa light.

The LEDs operate in three modes:

1. Cycle: When you continually press the LIGHT button, the LEDs will cycle through the three main LED colors (Red, Green, and Blue) or combinations of the three that produce the following colors: light green, purple, light blue, yellow, etc.

Each time you press the button, you immediately advance to the next color in sequence or eventually a different light pattern.

2. Flashing: When you are cycling through all the colors, the next time you push the LIGHT button, the LED lights may start flashing. This is another normal operational pattern option.

3. Fading cycle: The next phase of operation when you push the LIGHT button is a slow and/or fast fade random transition from one color to the next.

- If a spa is equipped with more than 100 points of light, the Slow Fading Cycle will flicker during a color change.
- Every air valve and water valve is equipped with 4 LED points.
- Every jet is equipped with 2 LED points.
- Perimeter LEDs take 9 points of light.
- The waterfall takes 4 points of light.

Spas with exterior corner LED lighting generally work in the same mode as described above. The variations in color and patterns provide you with multiple options to suit almost any lighting preference.

Diverter Knobs

Diverter knobs are 1" and 2" knobs located around the top of your spa. They allow you to divert water through jets from one side of the spa to the other, or in most cases from floor jets to wall jets. This is accomplished by rotating the diverter knob to the left (counterclockwise), decreasing the amount of water flow through a section of jets. To increase the amount of water flow through the other section of jets, rotate the handle to the right (clockwise).



Air Venturis

Air venturis are the 1" knobs located around the top of your spa. Each one will let you add a mixture of air with the jet pressure. This is accomplished by rotating the air venturi knob to the left (counterclockwise) to increase the amount of airflow through the jets. To decrease the amount of airflow through the jets, rotate the handle to the right (clockwise).



Waterfalls

Some spa series include optional waterfalls. When the booster pump is on, rotate the dial on top (for the cascade waterfall) or turn the knob (for the hydro streamer -- see below).



ATS Plus Therapy System



Adjustable Therapy System

Pump On / Off Button:

Press this button once to turn on the ATS pump. The pump will turn on full speed with letter "H" displayed in the seven segment LED, the Pump LED light on the control panel will appear and the back light will turn on if it was off previously. Press this button a second time to turn off the ATS pump, the Pump LED light, and clear the seven segment display. The ATS pump must be on before you can use any other features of this system.

Pulse Mode Button:

Press this button once to turn on the pulse mode. The last pulse mode number will be displayed and the ATS pump will run in the pulse mode that it displays. There are total of 9 pulse modes and user can choose the Up or Down button to select the desired pulse mode. Press this button a second time to turn off pulse mode and return to normal pump on with letter "H" displayed. See the image for 9 pulse mode descriptions.

Up / Down Buttons:

These buttons only activate when pulse mode is on. They allow you to cycle through 9 pulse modes. At the end of pulse mode 9, if the Up button is pushed the system will go to "DEMO" mode. In DEMO mode, the system will cycle through all 9 pulse modes with 30 seconds for each mode and flashing letter "d1" through "d9" while cycling through each pulse mode. At the end of demo pulse mode 9, the system will exit the demo mode and return to normal Pump On with letter "H" displayed.

Time Out:

The Pump On will run for 15 minutes, then automatically shut off. If the Pulse Mode button is pressed during this time, the timer will reset and allow Pulse Mode to run for 15 minutes, then automatically shut off. For another 15 minutes session, press the Pump On and the Pulse Mode button. Back light will timeout 30 minutes after Pump Off.

Pump Protection:

If the pump is getting too hot during pulse mode (or after stop), the Pulse Mode will stop and ATS system will automatically go to a cool down cycle. During cool down cycle, the pump will turn on full speed with flashing letter "C" displayed in the panel. The ATS system will run until pump temperature goes down and then turn off. Pulse Mode is disabled during cool down cycle and cool down cycle will take between 10 to 30 minutes.









Pump Purge:

To prevent water stagnation for a long time in the ATS system, the ATS system will purge water once a day. Every 24 hours from the last system run, the ATS system will turn on full speed for 20 seconds with flashing letter "P" displayed in the panel.

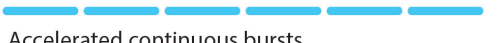
ATS Sensor:

ATS sensor is used to monitor temperature to prevent ATS system from freezing or getting too hot. If temperature is too cold, the ATS system will turn on full speed with flashing letter "F" displayed in the panel. If it is too hot, the system will turn on full speed with flashing letter "C" displayed in the panel. In these cases, it will run until pump temperature goes back to normal and the system will shut down automatically. If ATS sensor is not connected or not mounted to the system correctly, a flashing letter "E" will display in the panel when system is not running. With sensor error (flashing "E"), ATS system is still be able to operate normally but after the first 15 minutes of pulse mode, a flashing "L" will display in the panel. After the second 15 minutes of pulse mode, the system will force a cool down cycle for 30 minutes before user can use it again. There will be no freeze protection for sensor error and in some pulse modes the system will run very hot so user should fix the problem as soon as they can to enhance the pump life.



- 1  Low rolling bursts
- 2  Medium continuous bursts
- 3  Accelerated continuous bursts
- 4  Swift rolling bursts
- 5  3 gentle bursts followed by 1 vigorous burst
- 6  Quick, powerful continuous bursts
- 7  Gentle, powerful alternating bursts
- 8  Medium low rolling bursts
- 9  Extended low rolling bursts

Aquatic Air Therapy™ (AAT)

AQUATIC AIR THERAPY™ JETS

The Aquatic Air Therapy™ (AAT) Jets in conjunction with the massage ring provides a massage therapy experience for sore muscles or aching joints (Available only in select areas of spa).



FLEX JET™

The Flex Jet™ delivers a gentle but strong stream of water to more delicate areas of the body including wrists, joints and extra sensitive muscles. Experience immediate alleviation from the massage ring included on the Flex Jet™.



DUO JET™

The Duo Jet™ is perfect for larger parts of your body including lower back, legs and shoulders. Place your back on the Duo Jet™ for a complete rehabilitating massage therapy experience.



PRECISION JET™

The Precision Jet™ emits the perfect combination of air and water to target specific problematic areas while a soft massage ring provides relief on contact. Relieve muscle tension and soreness with the Precision Jet™.

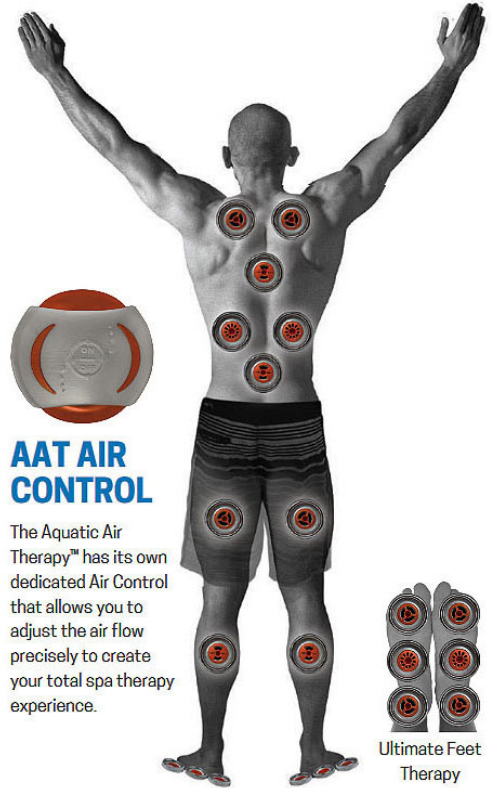

AAT AIR CONTROL

The Aquatic Air Therapy™ has its own dedicated Air Control that allows you to adjust the air flow precisely to create your total spa therapy experience.

Ultimate Feet
Therapy

Water Clarity

This section is intended for new spa owners with no experience with water chemistry. Everyone's experience with maintaining water quality is different, but there are some general concepts you need to know.

Water maintenance is not difficult, although it requires regular attention. The most important thing to understand about taking care of your spa water is that preventive action is much easier than correcting water quality issues.

The Key to Clear Water

Excellent water quality is a simple matter of four things:

Chemical Balance

You will need to test and adjust the chemical balance of your spa water. Although this is not difficult, it needs to be done regularly.

Depending on your choice of sanitizer, you need to test the level of calcium hardness, total alkalinity, and pH. Spa owners with a Cal Clarity II bromine generator also need to check total dissolved solids and phosphates.

See page 28 to learn how to balance your spa water.

Sanitation

Sanitizers kill bacteria and viruses and keep the water clean. A low sanitizer level will allow microbes to grow quickly in the spa water. We recommend using either chlorine or bromine as your sanitizer.

Spa owners with an ozonator also need to add sanitizer, although their requirements are different.

See page 29 to learn how to use sanitizer.

The Cal Pure Salt System bromine generator does NOT require sanitizer. See page 30 for a description of its use.

Filtration

Cleaning your filter regularly is the easiest and most effective single thing you can do to keep your water clear.

A clogged or dirty filter will cause the heater and pump to work harder than they need to, possibly causing them to fail.

The spa's heating system will only function with the proper amount of water flow through the system.

See page 30 for filter cleaning instructions.

Regularity

Clear water requires regular maintenance. Establish a routine based on a regular schedule for your spa water maintenance.

Maintaining your water quality helps the enjoyment of your spa and extends your spa's life by preventing damage from neglect and chemical abuse.

See page 33 for the schedule of recommended maintenance.



Testing and Adjusting Spa Water

You have two types of testing methods to choose from:

- **The reagent test kit** is a method which provides a high level of accuracy. It is available in either liquid or tablet form.
- **Test strips** are a convenient testing method commonly used by spa owners.

Balancing the Total Alkalinity

Total alkalinity (TA) is the measure of the total levels of carbonates, bicarbonates, hydroxides, and other alkaline substances in the water. TA can be considered a “pH buffer”. It is the measure of the ability of the water to resist changes in pH level.

The recommended total alkalinity is 80 - 120 ppm.

If the TA is too low, the pH level will fluctuate widely from high to low. Low TA can be corrected by adding an alkalinity increaser

If the TA is too high, the pH level will tend to be too high and may be difficult to bring down. High TA can be corrected by adding an alkalinity decreaser.

When the TA is balanced, it normally remains stable, although adding water with high or low alkalinity will raise or lower the TA level.

Balancing the Calcium Hardness

Calcium hardness (CH) is a measure of the total amount of dissolved calcium in the water. Calcium helps control the corrosive nature of the spa’s water and is why soft water is not recommended. The low calcium content of soft water is very corrosive to the equipment and can cause staining of the spa shell.

The recommended calcium hardness is 150 - 200 ppm.

If the CH is too low, add a calcium hardness increaser.

If the CH is too high, dilute the spa water with soft water.

When the CH is balanced, it normally remains stable, although adding soft water or very hard water will raise or lower the CH level.

Balancing the pH

The pH level is the measure of the balance between acidity and alkalinity.

If the pH is too low, it can cause corrosion of metal fixtures and the heating element. Low pH can be corrected by adding a pH increaser.

If the pH is too high, it can cause scaling by allowing metals or minerals to form deposits and stain spa surfaces. High pH can be corrected by adding a pH decreaser.

Ideal Water Chemistry

Testing For:	Ideal Range (ppm)	
	Minimum	Maximum
Total Alkalinity	80	120
Calcium Hardness	150	200
pH	7.2	7.6

Sanitation

Sanitizers kill bacteria and other organic waste by breaking them down to non-harmful levels and are filtered out. Before you fill your spa, you need to decide which chemical sanitizer you wish to use. Consult your Cal Spas dealer for the right decision with regards to your lifestyle and spa usage.

We recommend either **bromine** or **chlorine** as your sanitizer. Both work well when maintained regularly.

Do not use a sanitizer with the Cal Pure Salt System bromine generator. See page 31 for instructions on its use.



DO NOT use trichlor. Trichlor is very acidic and the hot temperature of the spa causes it to dissolve too quickly. It will cause damage to your spa and will void your warranty.

Whichever plan you decide on, follow it completely and don't take shortcuts. It will provide you with clean, safe, clear spa water with a minimum of effort. Spa owners with an ozonator still need to use a chemical sanitizer. See page 30 for a description of how the ozonator works.

Using Chlorine as a Sanitizer

If you choose to use chlorine as a sanitizer, only use granulated chlorine, not liquid chlorine.

Once a week, check the chlorine level using either a test strip or a reagent kit. See the table on the following page for the ideal range.

Add one or two tablespoons granulated chlorine to the spa water weekly. Note that chlorine dissipation rate will be faster at higher water temperatures and slower at lower temperatures.

When you add chlorine, open all of the jets and run the spa at high speed with the cover open for at least 30 minutes.

Follow the maintenance schedule on page 33.

Using Bromine as a Sanitizer

Bromine is a very effective sanitizer that produces low chemical odors. Unlike chlorine, it can break down bacteria and other impurities to a safe level with a low burn-out rate.

Use granulated sodium bromide to establish your bromine base.

When you begin with fresh water, add 2 ounces of granulated bromide. Open all of the jets and run the spa at high speed with the cover open for at least 30 minutes.

Follow the maintenance schedule on page 33.

Shocking the Water

In addition to using a chemical sanitizer, you will periodically need to shock the water. Shocking the water helps remove burned-out chemicals, bacteria, and other organic material from your spa's water and improves your sanitizer's effectiveness.

Do not use chlorinating shock, which will damage your spa's jets and pump seals. Only use an oxidizer shock. It can be used with either chlorine or bromine sanitizers.

Add one ounce of oxidizer shock once a week, after heavy bather loads, or if water has a strong odor.

Spa must be running with all of the jets on high for 30 minutes with the cover open. If necessary, repeat oxidizer shock in 30 minute intervals.

Do not use shock with the Cal Pure Salt System bromine generator. See page 31 for instructions on its use.

Testing For:	Ideal Range (ppm)	
	Minimum	Maximum
Chlorine level		
Without ozonator	3.0	5.0
With ozonator	2.0	4.0
Bromine level		
Without ozonator	6.7	11.0
With ozonator	5.7	10.0

Bather Load

“Bather Load” is the term used to describe the number of people using a spa, combined with the length of usage, and the frequency of usage. All these factors have a great effect on the spa water. The higher the bather load, the more chemicals need to be added and a longer filtration time will be needed.

Recommendations are designed for spas with average bather load (3 to 4 people, 15 minutes of usage, three times a week at 100 degrees) If your bather load exceeds these guidelines, and you experience water quality problems, increase the amount of filtration first, (go to the next higher filtration number) then if water quality is still not adequate, consult the advice of your Cal Spas dealer for additional chemical or system recommendations. Be sure to give them your bather load information.

Filter Cleaning

The filter is the part of your spa that removes the debris from the water and needs to be cleaned on a regular basis to maximize your spa’s filtering performance and heating efficiency.

In addition to spraying off the filter weekly to remove surface debris, your filter should be deep cleaned periodically to dissolve scale and particles that get lodged deep within the filter fibers and impede the filtration process. Even if the filter looks clean, scale and particles can clog the fibers and prevent water from flowing through the filter resulting in the most common spa problem—no heat, caused by a dirty filter.

We recommend you clean your filter once a month and replace it once a year or as necessary.

It is extremely important that you never run the spa without a filter. There is a possibility that debris may be sucked into the plumbing through the filter well.

Set the spa in Hold Mode before you remove the filter. Hold Mode pauses all spa operations for 60 minutes for service functions like cleaning or replacing the filter. See page 19 for instructions on using Hold Mode.

Cleaning the filter

1. Remove the filter by unscrewing it and pulling it up and out.
2. Place the dirty filter into a bucket of water deep enough to cover the filter. Add 8 oz. of liquid filter cleaner to the bucket of water.

Note: It is a good idea to keep a spare filter to use in the spa while the dirty filter is being deep cleaned. This way, you can rotate the filters and both will last longer.

3. Soak the filter for a minimum of 24 hours.
4. Spray the filter with a water hose. Spray each pleat carefully.
5. Reinstall the filter. Do not overtighten.

Ozonator

The ozone generator releases ozone into the spa water. You will still need to test for chlorine or bromine and occasionally replenish it to return the sanitizer level to the baseline.

For spas without a circulation pump, pump 1 will run at low speed and the ozonator will run during filtration.

For spas with a circulation pump, the ozonator will run with the circulation pump.

The spa’s control system is factory-programmed with one filter cycle that will run in the evening when energy rates are often lower. The time and duration of the filter cycle can be set according to your needs. In addition, a second filter cycle can be enabled. Filtration time may need to be increased with heavy bather load.

See instructions for setting filtration cycles on page 18.

Bromine Generator

The bromine generator automatically generates and releases free bromine into the spa water. You will still need to test for bromine and occasionally adjust it to return the bromine level to the baseline.

Start-up/Operating Instructions

Be certain that you start with a clean spa. It should be free of contaminants and other residues that can accumulate on the sides and/or around the jets. It is also important to only use spa cleaning products that have **no phosphates** or phosphonic acids since phosphates will deplete free bromine and are super-food for algae. Always start your spa with a clean filter before filling with water.

If the water source is "well water" or a non-municipal water source, have your water tested for Total Dissolved Solids (TDS) and metals. Water with high TDS is likely to have higher metal content and will need a metal remover to decrease the metals and ensure a successful start. This test can be done by your local spa dealer. The ideal range for your start-up TDS is between 50 and 200 ppm - mg/L. If TDS from your source water is above 500 ppm, a metal remover is strongly recommended.

DO NOT FILL THE SPA WITH SOFT WATER.

- Using your PURE FILL Spa Pre-Filter, fill your spa with water to the recommended level (six inches below the lip of the spa) and DO NOT FILL WITH WATER FROM A "RESIDENTIAL WATER SOFTENER."
- Before starting the system, balance your water chemistry to ensure a successful start up. Ideal ranges are as follows:

	Ideal Range	
	Minimum	Maximum
pH	7.2	7.6
Total alkalinity	80 ppm	120 ppm
Calcium hardness	150 ppm	250 ppm
Phosphates	0 ppb	30 ppb

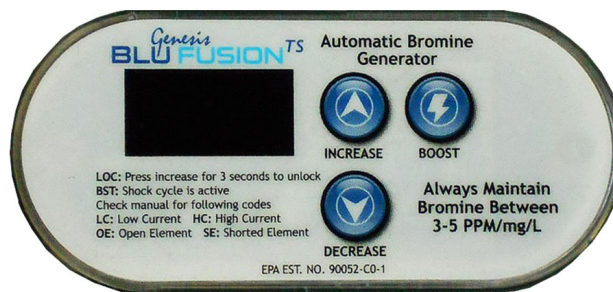

Use the phosphate test kit included with your system. Bromide residuals will be significantly reduced if phosphate levels are high. If phosphates are detected, purchase a phosphate remover and follow the directions accordingly. **Any** phosphates in your spa will reduce bromine levels.

- Determine the level of "NaBr" (Sodium Bromide) required for your spa size. NaBr should be added at a rate of 1.2 lbs per 100 gallons or approximately 1300-1500 ppm.

Example: For a 500 gallon spa add approximately 6 lbs of NaBr. **1.2 lbs x (5) 500 gallons = 6lbs NaBr.**

- Turn the jets on high speed. Sprinkle the NaBr across the surface of the water to evenly distribute the NaBr in the spa and circulate for 30 minutes.
- Test the Sodium Bromide concentration with the Tru-Blu NaBr test kit. The correct amount of NaBr will secure a reading of between 1300-1500 ppm.
- Adjust the filtration time to circulate for 8 hours every 24 hours on a 2 speed pump.
- For a spa between 300-500 gallons, start at a power level of "6" and then press the "boost" feature. This will accelerate the production of bromine for 8 hours. Wait for proper bromine levels before entering the spa.
- Always keep your bromine level between 3-5ppm. Test the bromine level after 24 hours and adjust the power setting accordingly. An occasional heavier bather load may require the "boost" feature.

Maintaining the Bromine Level

Always keep your spa or hot tub water in balance. Maintaining the pH and the alkalinity is part of being a spa owner.

The bromine generator requires you to determine your power setting based upon your circulation time and your spa usage. It requires a minimum of eight hours of circulation per day. If the spa is not circulating, the bromine generator is not generating bromine. If you find that you are having trouble maintaining the desired level, make sure the spa is circulating the required amount.

A spa that is frequently used will require a higher power setting. If you have a bromine reading that is too high or too low, adjust the **DECREASE / INCREASE** control accordingly. Depending on the amount usage, circulation time, and type of spa, each spa owner's setting will be different.

The bromine generator can go up to 12 months before a drain and fill is required, unlike non-equipped spas that require it every three months. This is because the bromine generator does not add unwanted chemical bi-products like traditional chemicals do.

Sodium bromide is not the only contributor to the TDS count in your water. Over time, the TDS count in your water will rise (from such things as residuals from other chemicals and minerals, and unfilterable material). Test the TDS every few months to make certain it stays within range.

Shower prior to entering any hot tub or spa. This will help prevent phosphate contamination and reduce the demand on the bromine.

Shocking your tub is recommended after heavy bather load.

Intelligent Controller Codes for the Bromine Generator



LC (Low Conductivity) will appear when the unit detects that the conductivity is below the minimum level. At start-up, you will experience this if you have not added the Sodium Bromide. Check the Sodium Bromide level in the water and add the appropriate amount per your spa. If the NaBr level is correct, the cell may be experiencing scaling. In this case, you will want to clean the cell. Please consult with your spa dealer for further information.

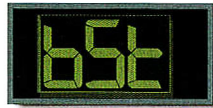

bSt (Boost) will appear when the BOOST feature is on. Depressing this key once will increase the bromine production to twice that of the last bromine production setting for the next *accumulated eight hours of pump circulation time*. The BOOST cycle should be depressed after heavy bather load or usage.



OE (Open Element) will appear if the system controller is unable to detect a connection to the electrode cell. You may see this if the electrode is not connected properly, there is inadequate water flow, or the cell is not functioning due to unknown circumstances. This may require that the cell be evaluated and possibly cleaned of scale build-up or even replaced. If this happens, please consult with your spa dealer.

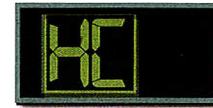

HC (High Current) will appear when the TDS (Total Dissolved Solids) is too high resulting in High Current at the electrode cell. If this reading appears at or near start up of your system, check your source water for TDS and proper NaBr readings. If this reading appears after an extended period of operation, draining 25% of the water and refilling can help reduce TDS levels. If "HC" remains present, consult with your spa dealer for a comprehensive water analysis and recommended course of action.

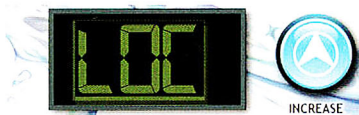

LOC: Press increase for 3 seconds to unlock

LOC (Locked) Your TopSide controller includes a "LOC" feature which ensures that the system is "Locked" when not being utilized to manage your Spa's water. Your system will automatically produce bromine when necessary. This feature is simply for your protection. In order to "Unlock" simply depress the "increase" key on your unit for 3 seconds.

Maintenance Schedule

Each time you refill the spa	Follow the section "Filling and Powering Up Your Portable Spa" on page 7.
Prior to each use	Test the spa water using either test strips a reagent test kit. Adjust chemical levels as necessary.
Once a week	Test the spa water using either test strips a reagent test kit. Adjust chemical levels as necessary. If your water source is high in calcium, add stain and scale preventer.
Once a month	Deep clean your spa's filter. (Follow filter cleaning instruction at beginning of this section)
Every two to four months	Change the spa water. How often you change the water depends on how much you use the spa. When you change the water, you will need to: <ul style="list-style-type: none"> • Clean and polish the acrylic surface (see page 38) • Clean and treat the spa cover and pillows (see page 38) • Deep clean the filter (see page 30) • Refill your spa (see page 7)
Once a year	Replace filter cartridges if the pleats appear frayed.

Troubleshooting Water Clarity Problems

Problem	Probable Causes	Possible Solutions
Cloudy Water	<ul style="list-style-type: none"> • Dirty filter • Excessive oils / organic matter • Improper sanitization • Suspended particles / organic matter • Overused or old water 	<ul style="list-style-type: none"> • Clean filter • Shock spa with sanitizer • Add sanitizer • Adjust pH and/or alkalinity to recommended range • Run jet pump and clean filter • Drain and refill the spa
Water Odor	<ul style="list-style-type: none"> • Excessive organics in water • Improper sanitization • Low pH 	<ul style="list-style-type: none"> • Shock spa with sanitizer • Add sanitizer • Adjust pH to recommended range
Chlorine Odor	<ul style="list-style-type: none"> • Chloramine level too high • Low pH 	<ul style="list-style-type: none"> • Shock spa with sanitizer • Adjust pH to recommended range
Musty Odor	<ul style="list-style-type: none"> • Bacteria or algae growth 	<ul style="list-style-type: none"> • Shock spa with sanitizer – if problem is visible or persistent, drain, clean and refill the spa
Organic buildup / scum ring around spa	<ul style="list-style-type: none"> • Buildup of oils and dirt 	<ul style="list-style-type: none"> • Wipe off scum with clean rag – if severe, drain the spa, use a spa surface and tile cleaner to remove the scum and refill the spa
Algae Growth	<ul style="list-style-type: none"> • High pH • Low sanitizer level 	<ul style="list-style-type: none"> • Shock spa with sanitizer and adjust pH • Shock spa with sanitizer and maintain sanitizer level
Eye Irritation	<ul style="list-style-type: none"> • Low pH • Low sanitizer level 	<ul style="list-style-type: none"> • Adjust pH • Shock spa with sanitizer and maintain sanitizer level
Skin Irritation / Rash	<ul style="list-style-type: none"> • Unsanitary water • Free chlorine level above 5 ppm 	<ul style="list-style-type: none"> • Shock spa with sanitizer and maintain sanitizer level • Allow free chlorine level to drop below 5 ppm before spa use
Stains	<ul style="list-style-type: none"> • Total alkalinity and/or pH too low • High iron or copper in source water 	<ul style="list-style-type: none"> • Adjust total alkalinity and/or pH • Use a stain and scale inhibitor
Scale	<ul style="list-style-type: none"> • High calcium content in water – total alkalinity and pH too high 	<ul style="list-style-type: none"> • Adjust total alkalinity and pH – if scale requires removal, drain the spa, scrub off the scale, refill the spa and balance the water • Use a stain and scale inhibitor

Removing and Reseating the Pillows

You can remove the pillows for cleaning and maintenance quickly and easily. This method works for all types of pillows.

Grab the lower edge of the pillow with both hands firmly and pull up. As you do this, the pillow inserts will pop out of the holes.

Reseat the pillows by aligning the pillow inserts with the holes and striking the pillow hard enough to insert the pegs back into the holes.

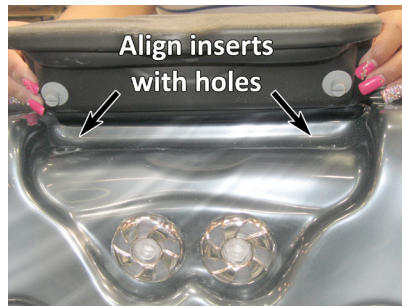

Jet Removal and Replacement

Jets can be easily removed for cleaning.

Grasp the outer rim of the jet and turn it counter-clockwise until it completely stops. You may feel it slightly loosen pop out a bit from the fixture. Pull the jet out from the jet fixture. The jet will be very snug and may require some force to remove it. **DO NOT PRY OUT JETS.**

To replace the jet, place it in the fitting and turn it clockwise until it snaps in and can be rotated freely about half a turn.

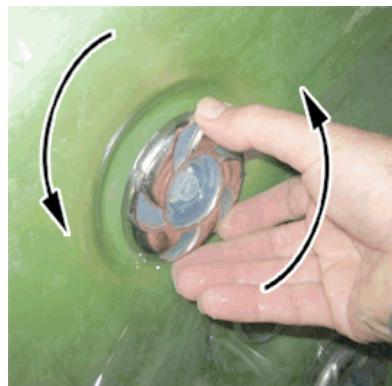

Spa Cover

Important! Keep the spa covered when not in use!

- Covered spas will use less electricity in maintaining your set temperature.
- Covering your spa will protect your spa's finish from the sun's ultraviolet rays.
- You are required to keep the spa covered to maintain warranty coverage.
- Covering your spa helps prevent children from drowning in the spa.

See the manual enclosed with your cover for instructions on mounting the locks and how to lock and unlock the cover.

In addition, while the spa cover is rigid, it is not designed to support any weight. Therefore, as a safety precaution and to preserve the life of your cover, you must not sit, stand, or lie on it, nor should you place objects of any kind on top of it.

Draining Your Portable Spa

Your spa should be drained every four to six months for cleaning and maintenance and refilled with fresh tap water. See page 38 for instructions on cleaning the shell, cover, and pillows. See page 7 for instructions on refilling your spa. Before you begin, turn off power to the spa at the breaker and remove all filters.

1. Locate your drain.

Pull the knob out of the cabinet. The cabinet drain is screwed into the drain pull knob.



2. Remove the cap

Make sure the valve is in the closed position, then unscrew and remove the cap. Unscrew the cap.



3. Connect valve to a garden hose.

Attach a garden hose to the hose-bib fixture. Place the other end of the garden hose where you would like the water to drain.

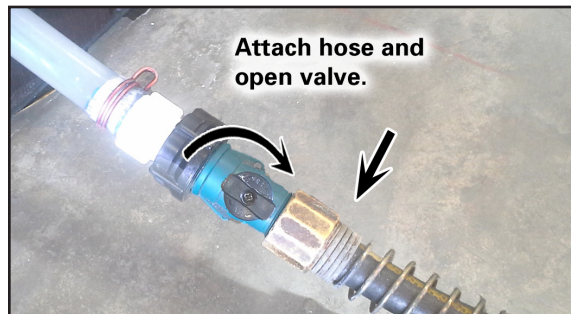

4. Drain the spa.

Turn the valve on the hose-bib fixture to open the drain. When the spa has drained completely, turn the valve on the hose-bib fixture, remove garden hose, and replace the cap.

Winterizing (Cold Climate Draining)

In many areas of the country, the temperature drops below 32°F (0°C). We recommend that you always have your spa full of water and running at normal spa temperatures (80°F to 100°F, 26.7°C to 37.8°C). This will help reduce the risk of freezing in your spa and your spa's equipment.

Warning: If you find the need to drain your spa, be aware of the potential of freezing in your spas equipment and plumbing. Even if the directions below are followed perfectly, there is no guarantee that your spa will not suffer freeze damage. Freeze damage is not covered by your warranty.

1. Open all filter covers.
2. Remove the filter baskets and filters.
3. Drain your spa completely as described in the instructions above.
4. Vacuum water from the spa's main drain fitting with a wet/dry vacuum.
5. Open the bleeder valves on the pumps.
6. For spas with the UV lamp chamber mounted flat on the equipment floor:
Loosen the quartz tube nut at the top of the UV lamp chamber and pull up the quartz tube to let the water drain from the UV lamp chamber.
7. Disconnect the unions from both sides of the pump.
8. Blow any remaining water out of the jets and equipment area with the wet/dry vacuum.
9. When it has completely finished draining, replace the quartz tube in the UV lamp chamber and retighten the nut. Close the bleeder valves and re-connect the unions on the pumps. Replace the filter baskets and filters.
10. Cover your spa with a good spa cover and an all-weather tarp to ensure that neither rain nor snow enters the spa.

Cleaning and Replacing the Filter

Filtration is one of the most important steps you can take to ensure clean, clear water. It is far less expensive to fix water clarity problems by filtering your spa than by using excessive amounts of chemicals, excessive filtration times, or by water replacement.

See the section "Filter Cleaning" on page 30 for more information.

Vacation Care

You can leave your spa unattended for up to two weeks if you follow these instructions.

ALWAYS lock your cover using the cover locks if you plan to be away from home and the spa is filled with water.

1. Select the Low Range temp choice used for vacation mode. (See instructions on page 16 for vacation setting.)
2. Following the water quality instructions starting on page 27, adjust the pH.
3. Shock the water (add either chlorine or bromine sanitizer).
4. When you return, check and adjust the pH and shock the water.

If you will not be using your spa for longer than 14 days and a spa maintenance service is not available, we strongly recommend you drain or winterize your spa.

Cleaning Your Spa

Spa Cover and Pillows

Due to the constant punishment your spa cover and pillows receive, you should protect them by applying a vinyl and leather cleaner as part of your monthly maintenance plan. Use a product that is specifically designed to protect spa covers and pillows from chemical and ultraviolet light damage without leaving an oily residue behind that is normally associated with common automotive vinyl protectants.

Warning: Do not use automotive vinyl protectants on spa covers or pillows. These products are generally oil-based and will cause severe water clarity issues that are difficult to correct.

Spa Shell

Each time you drain your spa, before you refill it you should clean your spa shell with an all-purpose cleaner and apply a coat of surface protectant.

Use a low detergent, non-abrasive cleaner specifically formulated to clean the spa without damaging its acrylic finish.

Use a non-oil based surface protectant that is specifically formulated to protect the spa's finish from the chemicals and minerals associated with normal spa use.

Replacement Parts

Snap-in SQR Jet Inserts

Velocity 5VTX Blue Jet

Symbol: 5VTX

Part #: PLU29950-011-400

Size: 5"D x 5.5"L



Velocity 5VTX LED Jet

Symbol: 5VTX

Part #: PLU29950-011-100

Size: 5"D x 5.5"L



Velocity Roto Blue Jet

Symbol: 5R

Part #: PLU29950-081-400

Size: 5"D x 5.5"L

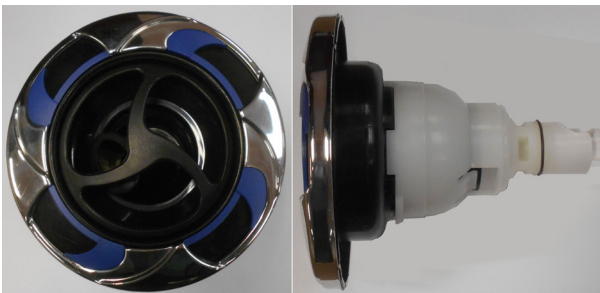

Snap-in SQR Jet Inserts

Velocity Roto LED Jet

Symbol: 5R

Part #: PLU29950-081-100

Size: 5"D x 5.5"L

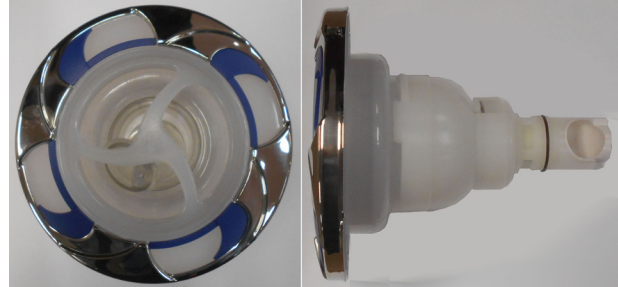

Velocity Directional Blue Jet

Symbol: 5D

Part #: PLU29950-012-400

Size: 5"D x 5.5"L



Velocity Directional LED Jet

Symbol: 5D

Part #: PLU29950-012-100

Size: 5"D x 5.5"L



Please visit www.quickspaparts.com
to order your replacement parts.

Snap-in SQR Jet Inserts

Velocity Massage-14 Blue Jet

Symbol: 5MM

Part #: PLU29950-071-400

Size: 5"D x 5.5"L



Snap-in SQR Jet Inserts

Velocity Tornado/WP LED Jet

Symbol: 5T

Part #: PLU29950-501-100

Size: 5"D x 5.5"L

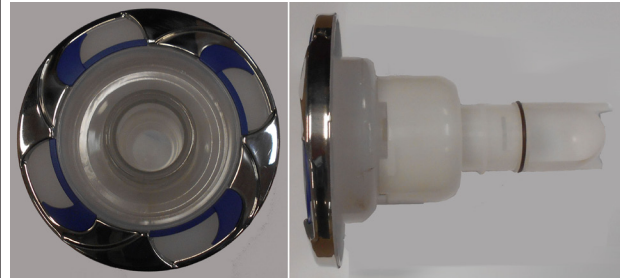

Velocity Massage-14 LED Jet

Symbol: 5MM

Part #: PLU29950-071-100

Size: 5"D x 5.5"L



Velocity Double Roto Blue Jet

Symbol: 5DR

Part #: PLU29950-032-400

Size: 5"D x 5.5"L



Velocity Tornado/WP Blue Jet

Symbol: 5T

Part #: PLU29950-501-400

Size: 5"D x 5.5"L

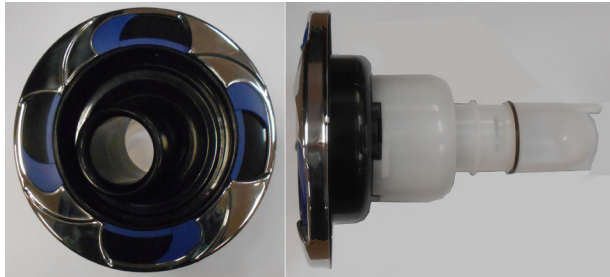

Velocity Double Roto LED Jet

Symbol: 5DR

Part #: PLU29950-032-100

Size: 5"D x 5.5"L



Please visit www.quickspaparts.com to order your replacement parts.

Snap-in SQR Jet Inserts

Velocity Directional Blue Jet

Symbol: 4D

Part #: PLU29940-112-400

Size: 4"D x 4.5"L



Velocity Directional LED Jet

Symbol: 4D

Part #: PLU29940-112-100

Size: 4"D x 4.5"L



Velocity Roto Blue Jet

Symbol: 4R

Part #: PLU29940-122-400

Size: 4"D x 4.5"L

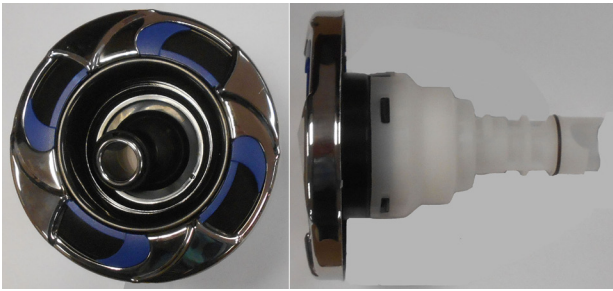

Snap-in SQR Jet Inserts

Velocity Roto LED Jet

Symbol: 4R

Part #: PLU29940-122-100

Size: 4"D x 4.5"L



Velocity Double Roto Blue Jet

Symbol: 3DR

Part #: PLU29930-191-400

Size: 3"D x 3.25"L

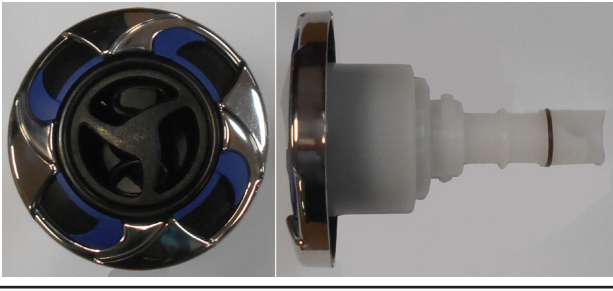

Velocity Double Roto LED Jet

Symbol: 3DR

Part #: PLU29930-191-100

Size: 3"D x 3.25"L



Please visit www.quickspaparts.com
to order your replacement parts.

Snap-in SQR Jet Inserts

Velocity Massage-7 Blue Jet

Symbol: 3M

Part #: PLU29930-142-400

Size: 3"D x 3.25"L

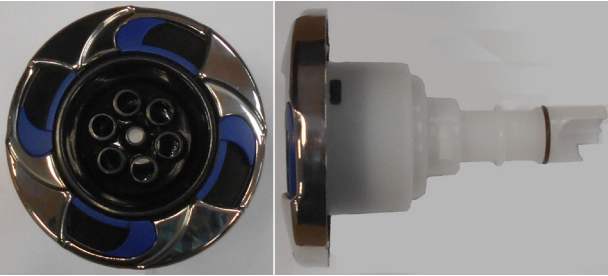

Velocity Massage-7 LED Jet

Symbol: 3M

Part #: PLU29930-142-100

Size: 3"D x 3.25"L



Velocity Directional Blue Jet

Symbol: 3D

Part #: PLU29930-112-400

Size: 3"D x 3.25"L

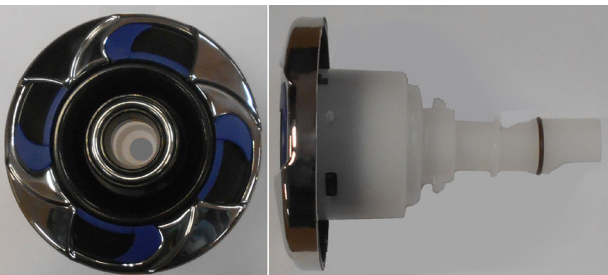

Snap-in SQR Jet Inserts

Velocity Directional LED Jet

Symbol: 3D

Part #: PLU29930-112-100

Size: 3"D x 3.25"L



Velocity Roto Blue Jet

Symbol: 2R

Part #: PLU29920-022-400

Size: 2"D x 3"L

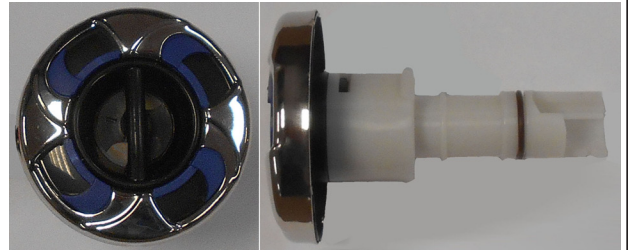

Velocity Roto LED Jet

Symbol: 2R

Part #: PLU29920-022-100

Size: 2"D x 3"L

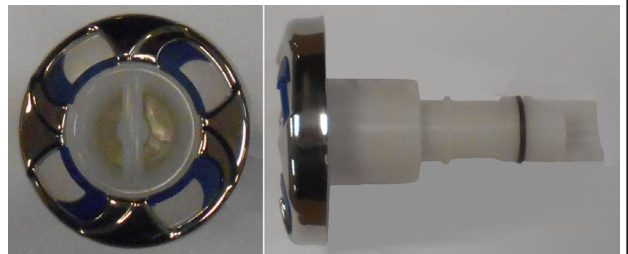

Please visit www.quickspaparts.com to order your replacement parts.

Snap-in SQR Jet Inserts	
Velocity Directional Blue Jet Symbol: 2D Part #: PLU29920-012-400 Size: 2"D x 3"L	
	
Velocity Directional LED Jet Symbol: 2D Part #: PLU29920-012-100 Size: 2"D x 3"L	
	

Jets	
Flex Jet PLU23512-311-100	
Duo Jet PLU23512-321-100	
Precision Jet PLU2312-331-100	
Pillows	
Cascade Pillow No Insert Black ACC01401031	 

Velocity Diverter Valves
Velocity 1" Blue Diverter Valve Symbol: D1 Part #: PLU25056-202-400 Size: 2.5" x 5"L

Please visit www.quickspaparts.com
to order your replacement parts.

Velocity Diverter Valves

Velocity

1" LED Diverter Valve

Symbol: D1

Part #: PLU25056-202-100

Size: 2.5" x 5"L



Velocity Air Control Blue

Symbol: A

Part #: PLU25059-202-400

Size: 3.125" x 5"L

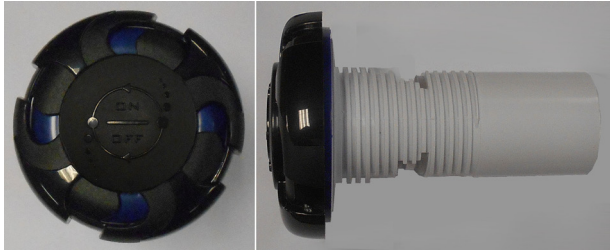

Velocity Air Control LED

Symbol: A

Part #: PLU25059-202-100

Size: 3.125" x 5"L

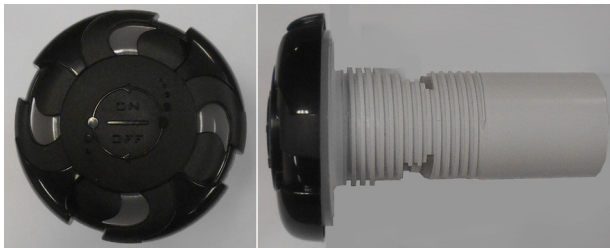

Velocity Diverter Valves

Velocity

2" Diverter Valve Blue

Symbol: D2

Part #: PLU25058-202-400

Size: 4.5" x 7.75"L

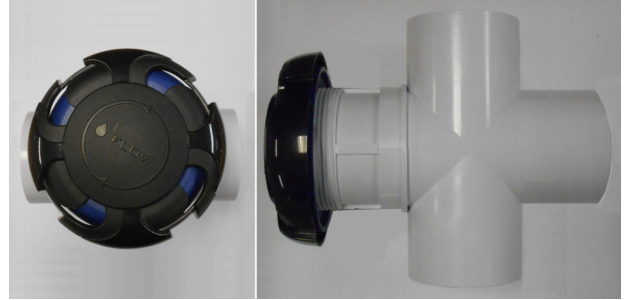

Velocity

2" Diverter Valve LED

Symbol: D2

Part #: PLU25058-202-100

Size: 4.5" x 7.75"L



Velocity Underwater

2" Diverter Valve Blue

Symbol: D2

Part #:

Size:

Velocity Diverter Valves	
Velocity Underwater 2" Diverter Valve LED Symbol: D2 Part #: Size:	
Velocity 1" Diverter Valve Wall Fitting LED Part #: PLU25030-089-200	
	
Velocity Air Control Wall Fitting LED Part #: PLU25090-089-200	
	

Velocity Diverter Valves	
Velocity 2" Diverter Valve Wall Fitting LED Part #: PLU25048-089-200	
	
Velocity Wall Fitting 2" Black (#25048-004-200) (for Diverter Valve) Part #: PLU21701738	
	
Velocity Wall Fitting 1" Black (#25030-004-200) (for On-Off Valve) Part #: PLU21701739	
	

Please visit www.quickspaparts.com to order your replacement parts.

Air Control Valve	
Aquatic Air Therapy (AAT) Air Control PLU25059-211-00	

Waterfalls	
Curved cascade waterfall assembly with logo PLU21801030	

Waterfall Cascade PLU21801037	
---	---



Accessories	
Cup Holder LIT25241-114-949	

Drains	
Drain Super Hi Flo Suction 2½" Black (640-3581LGV) PLU21400146	
Low Profile Drain ¾" Black (640-0511) PLU21400401	

Filters	
Filter Cartridge Anti-bacterial - 75 sq. ft. FIL75-5D17H15FCT-3	
Filter Cartridge Anti-bacterial - 75 sq. ft. FIL75-5D145H2OE-3	
DYNA FLO XTRA Lo-Pro 75 SQ. Ft. 2" CV, 4 SCALLOP (less cartridge) FIL11703305	

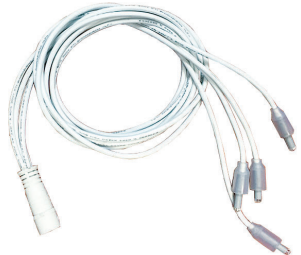
Please visit www.quickspaparts.com to order your replacement parts.

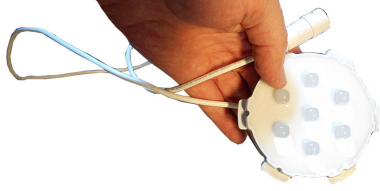
LED Lights	
1-LED light string LIT16100330	
2-LED light string LIT16100331	
4-LED light string LIT16100332	
1 to 3 ext. cord LIT16100335	
1 to 1 port ext. cord LIT16100338	
Interior light with logic (7 LED) LIT16100333	

LED Lights	
Interior light without logic (7 LED) LIT16100337	
Main light housing, LED lens, fitting nut LIT16100336	

Replacement Cabinet Panels

The complete selection of replacement cabinets for all models is very extensive and too lengthy for this owner's manual. To order replacement panels for your spa, visit www.quickspaparts.com.

Please visit www.quickspaparts.com to order your replacement parts.

Covers

All spa covers are designed with a tapered height, angling downward from the center to the sides to drive off rain and prevent water from pooling. The covers listed below are filled with either 1 lb., 1.5 lb., or 2.0 lb. foam.

Standard

4" - 2.5"

1.5 Lb. foam

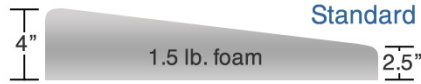

Deluxe

5" - 3"

2.0 Lb. foam

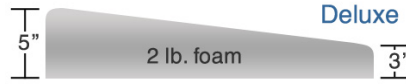

84" x 84" (7 foot spas)

Fits spa models: PL-760L, PL760B, PPL7L+, PPL7B

	Standard	Deluxe
Black	COV8484S53BK-BK-2	COV8484D53BK-BK-2
Gray	COV8484S53G-CC-2	COV8484D53G-CC-2
Slate	COV8484S53S-WN-2	COV8484D53S-WN-2

93" x 93" (8 foot spas)

Fits spa models: PL-860L, PL-861B, PL-880L, PL-881B, PPL8L+, PPL8B

	Standard	Deluxe
Black	COV9393S53BK-BK-2	COV9393D53BK-BK-2
Gray	COV9393S53G-CC-2	COV9393D53G-CC-2
Slate	COV9393D53S-WN-2	COV9393D53R-WW-2

Basic Troubleshooting

The troubleshooting guidance provided here is intended to cover the most common problems a spa owner may encounter. For more in-depth troubleshooting, go to www.calspas.com/troubleshooting.

Symptom	Possible Solutions
---------	--------------------

Problems starting up

Pump won't prime	See priming instructions on page 9.
Breaker keeps shutting off	Reset the GFCI breaker. If this continues, contact your dealer or a qualified spa technician.

Power and system problems

System won't start up or breaker keeps shutting off	Power may be shut off. Turn on GFCI circuit breaker. If this continues, contact your dealer or a qualified spa technician.
Control panel doesn't respond	Turn on or reset the GFCI circuit breaker. If this does not solve the problem, contact your dealer or a qualified spa technician. If you hear the pump running but the control panel doesn't respond, contact your dealer
Spa does not turn off	Spa may be trying to heat up. Check if spa is in Ready or Rest mode (see page 16) In cold climates, if spa is not equipped with full foam or any kind of insulation, it will try to maintain the set temperature. Set the spa to low temperature range and set the temperature to 80°F. Spa may be in filter cycle. If it is, this is normal and no adjustment is necessary.
Message on the control panel	There may be a problem. See Diagnostic Messages on page 21.

Heat problems

Spa water does not get hot	Spa may be in low temperature range. Set the spa to high temperature range. The filter may be dirty or may need to be replaced. Clean or replace the filter. The water level may be too low. Fill the spa with water level at 4 to 6 inches from the top. The temperature is not turned up high enough. Raise temperature on topside control. Cover the spa. The cover will keep heat in the spa and help keep heat from escaping. Make sure cover is on at all times when spa is not in use. The heater element may be old, deteriorated, coated with scale, or defective. Contact your dealer for more assistance. The gate valves may be partially or completely closed. NEVER OPERATE YOUR SPA WITH THE GATE VALVES CLOSED!
----------------------------	---

Symptom	Possible Solutions
Spa overheats - temperature greater than 110°F / 43°C	<p>Overheating can occur during summer months and may not necessarily indicate a malfunction. When it occurs, a message code may also appear on the control panel.</p> <p>Temperature may be set too high. Turn the set temperature down to a lower temperature.</p> <p>Filtration time may be too long. Turn the filtration cycles down during the warm months.</p> <p>The spa may not be properly ventilated. Make sure the front of the spa is not blocked to allow air flow.</p> <p>High speed pumps may have been running too long. Limit pump running time to no more than 15 to 30 minutes.</p>

Water pressure problems

Low water pressure	<p>Jet valves may be partially or fully closed. Open the jet valves.</p> <p>Filter cartridge may be dirty. Clean or replace the filter.</p> <p>Pump may have airlock. Remove airlock by priming spa (page 9)</p> <p>The suction fittings may be blocked. Remove any debris that may be blocking them.</p> <p>The filter skimmer may be blocked. Remove the blockage.</p> <p>Gate valves may be closed. Open gate valves. Note: Never operate your spa with the gate valves closed!</p> <p>Spa may be running in filtration mode. Press JETS or JETS 1 button to turn on high speed pump.</p>
No water pressure (no water stream from any jets)	<p>Power may be switched off. Turn the power back on.</p> <p>The pump may be defective. After you have tried all other troubleshooting, contact your dealer for assistance.</p>
Jets surge on and off	Water level may be too low. Add water to normal level.

Symptom	Possible Solutions
---------	--------------------

Pump problems

Pump runs constantly – will not shut off	There may be a problem with circuit board. Contact your dealer.
Noisy pump	<p>The water level may be too low. Fill the spa with water level at 4 to 6 inches from the top.</p> <p>Filter cartridge may be dirty. Clean or replace the filter.</p> <p>Pump may have airlock. Remove airlock by priming spa (page 9)</p> <p>The suction fittings may be blocked. Remove any debris that may be blocking the suction fittings.</p> <p>Gate valves may be closed. Open gate valves. Note: Never operate your spa with the gate valves closed!</p> <p>Air may be leaking into the suction line. Contact your dealer for assistance.</p> <p>Debris may be inside the pump. Contact your dealer for assistance.</p> <p>Noise may be a sign of damage. Contact your dealer for service.</p>
Pump turns off during operation	<p>Automatic timer may have completed its cycle. Press JETS or JETS 1 button to start the cycle again.</p> <p>Pump may have overheated due to the vents on the equipment door being blocked. Make sure the front of the spa is not blocked to allow air flow.</p> <p>The pump motor may be defective. Contact your dealer for assistance.</p>
Pump has a burning smell while running	A burning smell may be a sign of damage. Contact your dealer for service.
Pump does not run	<p>Pump may have over heated. Let it cool for an hour and try operating the spa for a shorter time.</p> <p>Power to the spa may be shut off. Turn on or reset the GFCI circuit breaker. If this does not solve the problem, contact your dealer or a qualified spa technician.</p>

“Thermal Creep”

Cal Spas are designed with energy-efficient components and systems that are meant to sustain heat generated by the equipment, which is then cycled back into the spa water. In hot weather or in situations where the spa is set to extended run times, Thermal Creep may occur. Thermal Creep is a condition where the measured water temperature can be higher than the set temperature. To manage Thermal Creep you may:

Vent your cover. This means placing a folded cloth about ¾” (2cm) thick under all four corners of the cover before you lock the cover down.

Open your cover. Opening the cover at night will also quickly cool the water down if desired.

Open all air controls. Set your filtration cycles to run during the cooler times of the day or night.

Reduce the length of your filter cycles.

Visit your local dealer for additional guidance.

Since Thermal Creep only occurs in well-insulated hot tubs, it is not indicative of something that is wrong with your spa or its equipment.

LIMITED WARRANTY

This Limited Warranty is extended to the original purchaser of a Cal Spa brand portable spa manufactured after January 1, 2018 and installed for residential use in the United States of America and Canada. This warranty begins on the date of delivery of the spa, but in no event later than one year from the date of manufacture.

Shell Structural

Warranted against water loss due to defects in the spa shell.

10 years

Shell Finish

Warranted against blistering, cracking, or delaminating of the interior surface of the spa shell.

7 years

Equipment and Controls

Electrical equipment components – specifically limited to the pumps, standard titanium heater, and control system – are warranted against malfunctions due to defects in workmanship or materials.

5 years

Plumbing

Warranted against leaks due to defects in workmanship or materials.

5 years

Cabinet - synthetic, fiberglass, or wicker

Warranted against defects in workmanship or materials. Normal wear and weathering of the finish will occur naturally over time and are not defects.

5 years

Warranties for Other Components

The fuses, headrests, cabinet finish, and filters are warranted to be free of defects in workmanship and material at the time of delivery. The factory installed water purification system is warranted against malfunction due to defects in workmanship or material for one year from the original date of delivery, except for the UV bulb and quartz tube, which are warranted for 90 days from the original date of the spa delivery. All stereo-related components (receiver, speakers, sub-woofer, stereo media locker, power supply, wireless remote control etc.) are warranted against malfunction due to defects in workmanship or material for one year from the original date of delivery. All other factory-installed components not mentioned specifically, including, but not limited to the wood frame, jets, diverter valves, LED lighting systems, filter lids, and mechanical components, are warranted against malfunction due to defects in workmanship and material for two years from the original date of delivery. The spa cover delivered with the spa is warranted for one year for Escape, Platinum, Fitness, and Special Edition spas, 90 days for Zone, Connect, and New Age spas.

Genuine Cal Spas Parts & Accessories

This Limited Warranty is void if Cal Spas (the "Manufacturer") or its designated representative determines that the spa has been subjected to damage or failure due to installation of aftermarket parts that are not genuine Cal Spas branded parts and accessories. This disclaimer includes, but is not limited to filters, UV bulbs, ozone systems, salt systems, repair parts and other accessories. Genuine Cal Spas brand parts and accessories are built to our highest standards of quality, durability and performance, and they are designed to work with your spa to ensure optimal performance and function.

Performance

This warranty begins on the date of delivery of the spa, but in no event later than one year from the date of manufacture.

To obtain service in the event of a defect covered by this Limited Warranty, notify your Cal Spa dealer or Cal Spas as soon as possible and use all reasonable means to protect the spa from further damage. Upon proof of purchase, a designated service representative will correct the defect subject to the terms and conditions contained in this Limited Warranty. There will be no charge for parts or labor to repair the defect, although providing access to affect the repair is your responsibility as the spa owner. Freight charges for replacement parts is the responsibility of the spa owner. You may be assessed reasonable repairman travel mileage charges.

In the event that the spa is removed to a repair facility for repair and reinstalled, the cost of removal and reinstallation will be your responsibility as the spa owner. If the Manufacturer determines that repair of the covered defect is not feasible, it reserves the right to provide a replacement spa instead, equal in value to the purchase price of the original spa. In such an event, reasonable costs for removal of the original spa, shipping costs from the factory for the replacement spa and delivery and installation of the replacement will be your responsibility as the spa owner. The replacement spa will carry the balance of the original spa's warranty. Spa covers are not included.

This warranty ends either by specified time frame, owner-transfer, relocation, or installation of any component other than by manufacturer.

Warranty Limitations

This Limited Warranty is void if Cal Spas or its designated representative determines that the spa has been subjected to alteration, neglect, misuse or abuse, or freight damage caused by the common carrier; any repairs have been attempted by anyone other than a designated representative; the failure is caused by accident, acts of God or other causes beyond the control of the Manufacturer; neglect, misuse and abuse include any installation, operation or maintenance of the spa other than in accordance with the instructions contained in the owner's manual provided with the spa, including but not limited to the failure to maintain proper water chemistry and chemical balance and the use of abrasive or improper cleaners or non-genuine parts and accessories. This Limited Warranty does not provide coverage for any item attached to or installed on the spa after the date of manufacture or for gaining access to any component for repair or replacement. Spa units in commercial use are excluded from any coverage whatsoever. The spa owner accepts liability for repair work performed by anyone other than the Manufacturer or a designated Cal Spa representative.

Limitations

The Manufacturer disclaims all warranties, expressed or implied, in fact or in law, to the extent allowed by your State's Law, including the warranty of merchantability and fitness for use, except as stated specifically herein. All warranty service must be performed by the Manufacturer or its designated representative using authorized Cal Spa parts. No agent, dealer, distributor, service company or other party is authorized to change, modify or extend the terms of this limited warranty in any manner whatsoever. The Manufacturer will not be responsible for any statements or representations made in any form that go beyond, are broader than, or are inconsistent with any authorized literature or specifications furnished by Cal Spas.

Disclaimers

The Manufacturer and its representatives shall not be liable for any injury, loss, cost or other damage, whether incidental or consequential, arising out of any defect covered by this limited warranty, including without limitation, loss of use of the spa and cost for removal of defective product even if the Manufacturer was advised of the possibility of damage. The liability of the Manufacturer under this limited warranty, if any, shall not exceed the original amount paid for the defective product. Coverage under this limited warranty shall commence as of the original date of delivery and the duration of such coverage shall not extend for any reason whatsoever beyond the stated time periods. These disclaimers shall be equally applicable to any service provided by the Manufacturer and its designated representatives.

Legal Rights

This Limited Warranty gives you specific legal rights. You may also have other rights that vary from state to state. Some states do not allow limitations on how long an implied warranty lasts, so this limitation may not apply to you.

Locating the product serial number

The serial number of your spa is located on a metal plate attached to the inside of the door for the equipment area. You will need this number to properly register your spa and activate coverage. Write this information in the space provided below.

Spa Model: _____

Spa Serial Number: _____

Date Purchased: _____

Date Installed: _____

Dealer's Phone Number: _____

Dealer's Address: _____

It is important that you register your Cal Spas product as soon as possible. By taking just a few quick minutes to register, you can enjoy product alerts, more efficient support, and quicker service. Go to www.calspas.com/warranty.

